













Model Description	Horse-power	Trim & Tilt/Starting Method	Shaft Length	Control Method	Model Year	Special Model Variation Code (Used on 25HP engines)
B = Inshore series C = C series model CV = C series D = Twin rotating propellers DX = Twin rotating propellers OX66 EFI E = Enduro series model F = Four stroke engine model LF = Left hand four stroke L = Left hand engine model LX = Left hand OX66 EFI LZ = Left hand HPDI P = Pro series model PX = Pro series OX66 EFI S = Saltwater series model SX = Saltwater series OX66 EFI T = Four stroke engine with high thrust V = V max series model VX = V max OX66 EFI VZ = V max HPDI Z = HPDI series	Example: 6 9.9 200 250	T = Power tilt or trim/tilt (1984-1990) P = Power tilt with electric start E = Electric start (1984-1990) M = Manual tilt with manual start	S = 15" L = 20" X = 25" U = 30"	R = Remote control H = Tiller handle J = Jet drive unit	N = 1984 K = 1985 J = 1986 H = 1987 G = 1988 F = 1989 D = 1990 P = 1991 Q = 1992 R = 1993 S = 1994 T = 1995 U = 1996 V = 1997 W = 1998 X = 1999 Y = 2000 Z = 2001 A = 2002 B = 2003 C = 2004 D = 2005	2 = 3 Cyl. 1997 3 = 3 Cyl.

Starting in April 2005 (2006 Model Year and newer) Yamaha no longer designated model years at the end of the model number identification. Beginning at this time any subsequent "new model" will have a letter designation between the Horsepower and the Control / Tilt Method.

Example:
 VZ300TLRD = 2005 VZ300TLR = New model after April 2005. VZ300BTLR = Newest Model and direct replacement for previous models.

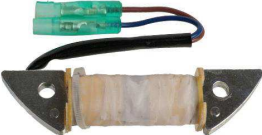
EXAMPLE: SX150TLRY - Saltwater EFI, 150 HP, Trim & Tilt w/electric start, 20", Remote control, 2000 model

 <p>18-5130 CDI Replaces: 688-85540-16-00 Fits: 90(1988-91), C75(1994-96), C85(1991-96), CV85(1989-90), E75(1995-96)</p>	 <p>18-5131 CDI Replaces: 695-85540-11, 695-85540-12-00 Fits: 9.9(1984-95), 15(1984-95), C25(1992-97), CV25(1990)</p>	 <p>18-5132 CDI Replaces: 63V-85540-00-00, 63V-85540-01-00, 63V-85540-02-00 Fits: 9.9(1999-09), 15(1999-09)</p>	 <p>18-23205 IGNITION COIL Replaces: 65W-85570-01-00 Fits: Yamaha F25(2005)</p>
 <p>18-23601 IGNITION COIL Replaces: 66M-85570-00-00 Fits: F9.9(2005-06), F15(1998-05), T9.9(2005-06)</p>	 <p>18-23602 IGNITION COIL Replaces: 63V-85570-00-00 Fits: 9.9(1996-09), 15(1996-09)</p>	 <p>18-5110 IGNITION COIL Replaces: 6E5-85570-11-00 For: 115 (4 cyl.) 1985-91</p>	 <p>18-5111 IGNITION COIL Replaces: 697-85570-11-00 For: 55 (2 cyl.) 1989-94 and 90 1984-88</p>
 <p>18-5112 IGNITION COIL Replaces: 6E7-85570-19-00, 680-85570-09-00, 6E7-85570-10-00, 695-85570-10-00 For: 9.9/15 (1988-93)</p>	 <p>18-5128 IGNITION COIL Replaces: 6R3-85570-01-00 For: 115/130/150HP (1994-04) 175HP (1994-95, 1997-98, 2000) 200HP (1994-98) 225HP (1997) B115HP 1998-99) C115HP (1997-98) for late model V4 & V6</p>	 <p>18-5183 COIL, CHARGE Replaces: 63V-85520-00, 63V-85520-01 Fits: 9.9(1996-09), 15(1996-09)</p>	 <p>18-5195 COIL, IGNITION Replaces: 689-81311-40-00 Fits: 25(1984-87), 30(1984-86), C30(1991-92), C40(1994-97), CV30(1989-90), CV40(1990)</p>



18-5138
COIL, IGNITION
 Replaces: 680-85570-00-00;
 680-85570-02-00
 Fits: T6 (02-05); F6, F8 (01-05); C25
 (96-97)



18-5119
COIL, IGNITION
 Replaces: 65E-85570-00-00



18-5113
COIL, IGNITION
 Replaces: 61N-85570-00-00,
 61N-85570-10-00
 Fits: 25(1994-95, 2001-09)



18-25650
COIL, PULSER
 Replaces: 66M-85580-00-00
 Fits: F9.9(2005-06), T9.9(2005-06),
 F15(1998-06)



18-25652
COIL, PULSER
 Replaces: 63V-85580-01-00
 Fits: 9.9(2003-09), 15(2003-09)



18-25604
LIGHTING COIL
 Replaces: 63V-85533-00-00
 Fits: 9.9(1996-09), 15(1996-09)



18-25600
COIL, CHARGE
 Replaces: 66M-85520-00-00
 Fits: F9.9(2005-06), T9.9(2005-06),
 F15(1998-06)



18-5135
CDI
 Replaces: 6E5-85540-10-00,
 6E5-85540-11-00, 6E5-85540-12-00
 Fits: 115 ET 1984-1989; 130 ET 1988-1989; C115TLR
 1991-1996; C115TXR 1992-1996; L130ETX 1989; 1989
 2-225HP



18-5136
CDI
 Replaces: 6F5-85540-21-00,
 6F5-85540-22-00
 Fits: 40HP 2 Cylinder (Int'l)















18-25300
CDI UNIT ASSEMBLY
 Replaces: 66M-85540-01-00
 Fits: F9.9(2005-06), F15(2000-06)

PREMIUM MARINE SPARK PLUG WIRE LEADS

Sierra's MAGFORCE Ignition Wires are "Electronics Friendly" protecting all of your electronic devices and electronic engine controls from RFI and EMI while delivering the maximum amount of voltage. Exact fit design ensures easy installation and years of trouble - free service.

Part #	OEM #	Application
18-5217-1	67F-82341-00-00	F75 (2003-2017), F80 (1999-2003), F90 (2003-2017), F100 (1999-2003)
18-5218-1	67F-82342-00-00	F75 (2003-2017), F80 (1999-2003), F90 (2003-2017), F100 (1999-2003)
18-5219-1	67F-82343-00-00	F75 (2003-2017), F80 (1999-2003), F90 (2003-2017), F100 (1999-2003)
18-5220-1	67F-82344-00-00	F75 (2003-2017), F80 (1999-2003), F90 (2003-2017), F100 (1999-2003)
18-8847-1 (Set)	67F-82341-00-00 + 67F-82342-00-00 + 67F-82343-00-00 + 67F-82344-00-00	F75 (2003-2017), F80 (1999-2003), F90 (2003-2017), F100 (1999-2003)



 <p>MP39160 MOMENTARY PUSH SWITCH For outboard installations.</p>	 <p>MP51020 (CLAMSHELL) MP51022 (BULK 100 PCS/CTN) IGNITION SWITCH Replaces: 703-82510-12-00 Yamaha Control Box 2 & 4 stroke Colors on wires match factory color codes</p>	 <p>MP51030 (CLAMSHELL) MP51032 (BULK 100 PCS/CTN) IGNITION SWITCH Replaces: 61B-82510-01-00, 61B-82510-00-00 Yamaha Dash Mount 2 Stroke Dual Engine Application Colors on wires match factory color codes</p>
 <p>MP51040 (CLAMSHELL) MP51042 (BULK 100 PCS/CTN) IGNITION SWITCH Replaces: 703-82510-43-00 Yamaha Control Box 2 & 4 stroke Push to Choke Colors on wires match factory color codes</p>	 <p>MP51050 (CLAMSHELL) MP51052 (BULK 100 PCS/CTN) IGNITION SWITCH Replaces: 6K1-82510-06-00 Yamaha Dash Mount 2 & 4 Stroke Dual Engine Application, Push to Choke Colors on wires match factory color codes</p>	 <p>MP28860 IGNITION LANAYARD Replaces: 682-82556-00-00</p>
 <p>18-65450 ENGINE STOP SWITCH Replaces: 6E9-82575-02-00 Fits: Yamaha 6(1995-00), 8(1995-09), 9.9(1994-95), C30(1994-96), C40(1994-97)</p>	 <p>18-5225 SPARK PLUG WIRE KIT Kit includes 25 ft. Roll of 7 MM Hypalon Ignition Wire With a Metallic Core and a Large Assortment of Three Different End Fittings to Fit Outboard Motors.</p>	 <p>18-5226 IGNITION WIRE Metallic Core 100' Spool 7mm Hypalon</p>
<p>PKG. OF 10</p>  <p>18-5750 18-5750-9① UNIVERSAL SPARK PLUG BOOTS Replaces: OMC 581027, 580339 Supplied complete w/Terminal Connector</p>	 <p>18-5752 UNIVERSAL SPARK PLUG BOOTS 8mm</p>	<p>PKG. OF 10</p>  <p>18-5224 18-5224-9① SPARK PLUG WIRE TERMINAL Replaces: Mercury 20121 OMC 510364</p>

① Priced per Package

YAMAHA OUTBOARD IGNITION CHART APPLICATION

HP	Year Start	Year Stop	CDI	Ignition Coil	Charge Coil (Stator)	Pulser Coil	Lighting Coil
9.9	1984	1995	18-5131	18-5111	-	-	-
9.9	1996	1998	-	18-23602	18-5183	18-25652	18-25604
9.9	1999	2009	18-5132	18-23602	18-5183	18-25652	18-25604
15	1984	1995	18-5131	18-5112	-	-	-
15	1996	1998	-	18-23602	18-5183	18-25652	18-25604
15	1999	2009	18-5132	-	18-5183	18-25652	18-25604
20	1996	1997	-	18-5113	-	-	-
25	1984	1987	-	-	18-5195	-	-

APPLICATION CONTINUED ON NEXT PAGE

YAMAHA OUTBOARD IGNITION CHART APPLICATION (Cont.)

HP	Year Start	Year Stop	CDI	Ignition Coil	Charge Coil (Stator)	Pulser Coil	Lighting Coil
25	1994	2009	-	18-5113	-	-	-
30	1984	1986	-	-	18-5195	-	-
90	1984	1988	-	18-5111	-	-	-
90	1988	1991	18-5130	-	-	-	-
115	1984	1989	18-5135	18-5110	-	-	-
115	1994	2009	-	18-5128	-	-	-
130	1988	1989	18-5135	18-5110	-	-	-
130	1994	2004	-	18-5112	-	-	-
150	1984	1989	-	18-5110	-	-	-
150	1994	2009	-	18-5112	-	-	-
175	1984	1989	-	18-5110	-	-	-
175	1994	1995	-	18-5112	-	-	-
175	2000	2000	-	18-5112	-	-	-
200	1984	1989	-	18-5110	-	-	-
200	1994	1998	-	18-5112	-	-	-
225	1994	1997	-	18-5112	-	-	-
B115	1998	1999	-	18-5112	-	-	-
C25	1992	1995	18-5131	18-5112	-	-	-
C25	1996	1997	18-5131	18-5138	-	-	-
C30	1991	1992	-	-	18-5195	-	-
C30	1993	1997	-	18-5113	-	-	-
C40	1991	1997	-	-	18-5195	-	-
C55	1991	1994	-	18-5111	-	-	-
C75	1994	1996	18-5130	-	-	-	-
C85	1991	1996	18-5130	-	-	-	-
C115	1991	1996	18-5135	18-5110	-	-	-
C115	1997	2000	-	18-5112	-	-	-
C150	1996	1999	-	18-5112	-	-	-
CV25	1990	1990	18-5131	18-5112	-	-	-
CV30	1989	1990	-	-	18-5195	-	-
CV40	1990	1990	-	-	18-5195	-	-
CV55	1989	1990	-	18-5111	-	-	-
CV85	1989	1990	18-5130	-	-	-	-
D150	1997	1999	-	18-5112	-	-	-
E48	1995	1996	-	18-5112	-	-	-
E75	1995	1996	18-5130	-	-	-	-
F6	2001	2008	-	18-5138	-	-	-
F8	2001	2015	-	18-5138	-	-	-
F9.9	2005	2006	18-25300	18-23601	18-25600	18-25650	-
F9.9	2007	2014	-	18-5138	-	-	-
F15	1998	1999	-	18-23601	18-25600	18-25650	-
F15	2000	2005	18-25300	18-23601	18-25600	18-25650	-
F25	1998	2004	-	18-23205	-	-	-
F25	2005	2005	-	18-23205	-	-	-
F30	2001	2005	-	-	-	-	-
F40	2000	2008	-	-	-	-	-
L130	1989	1989	18-5135	18-5110	-	-	-
L130	1994	2001	-	18-5112	-	-	-
L150	1986	1989	-	18-5110	-	-	-
L150	1994	1999	-	18-5112	-	-	-
L200	1986	1989	-	18-5110	-	-	-
L200	1994	1999	-	18-5112	-	-	-
P115	1994	1996	-	18-5112	-	-	-
P150	1994	1999	-	18-5112	-	-	-

APPLICATION CONTINUED ON NEXT PAGE

YAMAHA OUTBOARD IGNITION CHART APPLICATION (Cont.)

HP	Year Start	Year Stop	CDI	Ignition Coil	Charge Coil (Stator)	Pulser Coil	Lighting Coil
P175	1994	1999	-	18-5112	-	-	-
P200	1994	1999	-	18-5112	-	-	-
PROV150	1986	1989	-	18-5110	-	-	-
S115	1996	1999	-	18-5112	-	-	-
S130	1996	1999	-	18-5112	-	-	-
S150	1996	1999	-	18-5112	-	-	-
S175	1996	1999	-	18-5112	-	-	-
S200	1996	1999	-	18-5112	-	-	-
T8	2001	2010	-	18-5138	-	-	-
T9.9	2005	2006	18-25300	18-23601	18-25600	18-25650	-
T9.9	2007	2014	-	18-5138	-	-	-
T25	2001	2004	-	-	-	-	-
T25	2005	2005	-	18-23205	-	-	-
T25	2006	2006	-	-	-	-	-
V150	2000	2008	-	18-5112	-	-	-
V175	2000	2000	-	18-5112	-	-	-
V6EXCEL	1987	1989	-	18-5110	-	-	-
V6SPECIAL	1984	1986	-	18-5110	-	-	-



**18-5819
SOLENOID**
Replaces: 65W-81941-00-00
For: F25 (1998-04), F30 (2001-04), F40 (2000-04)



**18-5853
SOLENOID**
Replaces: 61A-81941-00-00, 6E5-81941-11-00, 6E5-81941-10-00, 6E5-81941-00-00
For: 2-Stroke: 115hp - 150hp. (1994-Current); 175hp (1994-2000); 200hp (1994-2005); 225hp. (1995-2004); 250hp (1990-2004)



**18-5821
STARTER
SOLENOID**
Replaces: 6G1-81941-10-00
Fits: 9.9/15(1988-97), 20(1996-97), 25(1985, 1988-99), 30(1985-87, 1989-93, 1996-99, 2001), 40(1989-90, 1992-01), 50(1989-97, 1999-02), 1990(1992-02), F15(1998-03), F40(1999), F50(1996-02), F60(2002-03), F75(2003-04), F80(1999-03), F90(2003-04), F100(1999-02)



**18-5879
SOLENOID**
Replaces: 688-81950-10-00, 688-81941-00-00
For: 2-Stroke: 40hp (1984-88); 50hp (1984-88); 60hp. (2001-06); 70hp. (1991-Current); 90hp. (1984-91)



**18-5746
STATOR ASSEMBLY**
Replaces: 6H3-85510-A0, 6H3-85510-A1
Fits: E60(1995-99), P60(1991), 70(1984-91)



**18-17301
RECTIFIER
REGULATOR ASSEMBLY**
Replaces: 6J8-81960-00-00
Fits: 25(1997-02), 30(1997-02)

CE



**18-6410
OUTBOARD STARTER**
Replaces: Yamaha 689-81800-13-00, 689-81800-11, 689-81800-12
Fits: 25-40HP (11 tooth)

CE



**18-6411
OUTBOARD STARTER**
Replaces: 6H3-81800-11-00, 6H3-81800-10
Fits: 60HP

CE



**18-6412
OUTBOARD STARTER**
Replaces: 697-81800-12, 99999-03249-00
Fits: 55-60HP 2 cylinder (9 tooth)



18-6413
OUTBOARD STARTER
 Replaces: 6E5-81800-11-00,
 6E5-81800-12-00
 Fits: 55-60HP 2 cylinder (9 tooth)



18-6415
OUTBOARD STARTER
 Replaces: 6N7-81800-10-00
 Fits: 115-250HP (9 tooth)



18-6961
STARTER
 Replaces: 6CB-81800-00-00
 Fits: 200, 225, 250 4 Cycle (2006 & Up)



18-6420
OUTBOARD STARTER
 Replaces: 6L2-81800-20-00
 Fits: 20HP MLHU & MSHU (1996),
 20HP MLHV & MSHV 1997 25 (1988-98)



18-6421
OUTBOARD STARTER
 Replaces: 6F5-81800-11, 6J4-81800-01-00
 Fits: 25HP (1999&2001), 30HP (1996-99 & 2001),
 40HP (1992-03) C40 1997-02, P40 (1998)
 50 (1992-97 & 2000 & 2002-03) C50 (1998-01), P50 (1993-96)



18-6422
OUTBOARD STARTER
 Replaces: 6H4-81800-12-00
 Fits: 40HP (1984-86), 50HP (1986-88), Pro 50
 (1987-88)



18-6423
OUTBOARD STARTER
 Replaces: 688-81800-12-00
 Fits: C75 (1994-96), (1998-99), P75 (1996-99),
 C80 TLRV (1997), C85 (1991-96)
 CV85 (1990), 90 (1984-03), B90 (1998-99) C90 (1997-01)



18-6425
OUTBOARD STARTER
 Replaces: 67F-81800-02-00
 Fits: F75 (2003), F80 (2001-02), F90 (2003), F100
 (2001-02)



18-6426
OUTBOARD STARTER
 Replaces: 68F-81800-01-00
 Fits: LZ150(00-05), LZ200(00-11), VZ150(00-11),
 VZ175(01-11), VZ200(01-04), Z150(00-05), Z175(01-
 05), Z200(00-11)

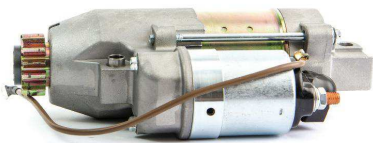

18-6427
OUTBOARD STARTER
 Replaces: 68V-81800-01-00
 Fits: F115 2001-03



18-6832
STARTER
 Replaces: 60V-81800-00-00,
 60X-81800-00-00
 Fits: 250HP engines 2003-04



18-6833
STARTER
 Replaces: 69J-81800-00-00
 Fits: 2002-2004 200-225HP



18-6861
STARTER
 Replaces: Yamaha 61A-81800-01-00,
 69L-81800-00-00, 69W-81800-00
 Hitachi S114-559B
 Fits: Yamaha 200-250HP Engines



18-6942
STARTER
 Replaces: Yamaha 69W-81800-00-00
 Hitachi S114-682
 Fits: 2002-04 60HP, 2003-04 50HP



18-6943
STARTER
 Replaces: 66M-81800-01-00, 02-00
 Fits: 9.9-15HP Engines

HP	Stroke	Model	Year	Starter	HP	Stroke	Model	Year	Starter
9.9		9.9	1984-1997	18-6420	40		40TLRA - 40TLRZ	1994-2005	18-6421
9.9	4	F9.9ELR2	2006 & UP	18-6943	40		C40	1991-1997	18-6410
9.9		F9.9ELR2D	2005	18-6943	40		C40ELRP	1991	18-6410
9.9	4	F9.9MLH2	2006 & UP	18-6943	40		C40ELRQ - C40TLRZ	1992-2001	18-6410
9.9		F9.9MLH2D	2005	18-6943	40		CV40ELD	1990	18-6410
9.9	4	F9.9MSH2D	2006 & UP	18-6943	40		F40TLRX	1999	18-6413
9.9		F9.9MSH2D	2005	18-6943	40		P40	1998	18-6421
9.9	4	T9.9ELH2	2006 & UP	18-6943	40		P40TLHW - P40TLRW	1998	18-6421
9.9		T9.9ELH2D	2005	18-6943	50		50	1984-1988	18-6422
9.9	4	T9.9ELR2 - T9.9EXH2	2006 & UP	18-6943	50		50	1989-2009	18-6421
9.9		T9.9EXH2D	2005	18-6943	50		50EJRQ - 50TLHV	1992-2001	18-6421
15		15	1984-1997	18-6420	50	2	50TLR	2006 & UP	18-6421
15	4	F15ELH	2006 & UP	18-6943	50		50TLRA - 50TLRZ	1996-2005	18-6421
15		F15ELHA - F15ELHD	2002-2005	18-6943	50		C50	1998-2001	18-6421
15	4	F15ELHK	2006 & UP	18-6943	50		C50TLRW - C50TLRZ	1998-2001	18-6421
15		F15ELHY - F15ELHZ	2000-2001	18-6943	50		F50	1995-2002	18-6413
15	4	F15ESH	2006 & UP	18-6943	50		F50TJRA - F50TLRZ	1995-2002	18-6413
15		F15ESHA - F15ESHD	2002-2005	18-6943	50		P50	1991-1996	18-6421
15	4	F15ESHK	2006 & UP	18-6943	50		P50TLRR - P50TLRU	1993-1996	18-6413
15		F15ESHY - F15ESHZ	2000-2001	18-6943	50		T50	1996-2002	18-6413
15	4	F15MLH	2006 & UP	18-6943	50		T50TLRA - T50TLRY	1996-2002	18-6413
15		F15MLHA - F15MLHD	2002-2005	18-6943	55		C55	1991-1995	18-6412
15	4	F15MLHK	2006 & UP	18-6943	55		CV55	1989-1990	18-6412
15		F15MLHY - F15MLHZ	2000-2001	18-6943	60		60	2001-2005	18-6411
15	4	F15MSH	2006 & UP	18-6943	60	2	60TLR	2006 & UP	18-6411
15		F15MSHA - F15MSHD	2002-2005	18-6943	60		60TLRA - 60TLRZ	2001-2005	18-6411
15	4	F15MSHK	2006 & UP	18-6943	60		C60	1996-2001	18-6411
15		F15MSHY - F15MSHZ	2000-2001	18-6943	60		C60ELRU - C60TLRZ	1996-2001	18-6411
15	4	F15PLH	2006 & UP	18-6943	60		P60	1991-1999	18-6411
15		F15PLHA - F15PLHD	2002-2005	18-6943	60		P60TLHP - P60TLHX	1991-1999	18-6411
15	4	F15PLHK	2006 & UP	18-6943	70		70	1984-2009	18-6411
15		F15PLHZ	2001	18-6943	70		70ETLD - 70ETLN	1984-1990	18-6411
15	4	F15PLR	2006 & UP	18-6943	70	2	70TLR	2006 & UP	18-6411
15		F15PLRA - F15PLRD	2002-2005	18-6943	70		70ETLN - 70TRP	1984-2005	18-6411
15	4	F15PLRK	2006 & UP	18-6943	70		C70	2000-2001	18-6411
15		F15PLRZ	2001	18-6943	70		C70TLRY - C70TLRZ	2000-2001	18-6411
25		25 (2 CYL)	1984-1987	18-6410	75		C75	1994-1999	18-6423
25		25 (2 CYL)	1988-2009	18-6420	75		C75TLRS - C75TLRX	1994-1999	18-6423
25		C25	1991-1997	18-6410	75		F75	2003-2004	18-6425
25		CV25	1990	18-6410	75		F75	2005-2011	18-6427
25	2	25ELH	2006 & UP	18-6420	75		F75TLRB - F75TLRD	2003-2005	18-6425
25		25ELH - 25ELN	1984-1987	18-6410	75		F75TLRD	2005	18-6427
25	2	25ELR	2006 & UP	18-6420	75		P75	1996-1999	18-6423
25	2	25ESH	2006 & UP	18-6420	75		P75TLHU - P75TLHX	1996-1999	18-6423
25		25ESH - 25ESN	1984-1987	18-6410	80		C80	1997	18-6423
25	2	25ESR	2006 & UP	18-6420	80		C80TLRV	1997	18-6423
25		25LH - 25LN	1984-1987	18-6410	80		F80	1999-2003	18-6425
25	2	25MLH	2006 & UP	18-6420	80		F80TJRA - F80TLRZ	2001-2003	18-6425
25		25MLHX3	1999	18-6421	85		C85	1991-1996	18-6423
25	2	25MSH	2006 & UP	18-6420	85		C85ELD - C85TLRU	1990-1996	18-6410
25		25MSHX3 - 25MSHZ3	1999-2001	18-6421	85		CV85	1989-1990	18-6423
25		25SH - 25SN	1984-1987	18-6410	85		CV85ELF	1989	18-6410
25		C25ELD - C25HSHV	1990-1997	18-6410	90		90	1984-2009	18-6423
30		30	1984-1986	18-6410	90		90ETLD - 90TJRZ	1984-2001	18-6410
30		30	1987-2001	18-6421	90	2	90TLR	2006 & UP	18-6410
30		30ELHT - 30ELHY	1995-2001	18-6421	90		90TLRA - 90TLRZ	1991-2005	18-6410
30		30ELJ - 30ELN	1984-1986	18-6410	90		B90	1997-1999	18-6423
30		30ELRT - 30ELRZ	1995-2001	18-6421	90		B90TLRV - B90TLRX	1997-1999	18-6410
30		30ESJ - 30ESN	1984-1986	18-6410	90		C90	1997-2001	18-6423
30		30ESRT - 30MSHZ	1995-2001	18-6421	90		C90TLRV - C90TLRZ	1997-2001	18-6410
30		C30	1991-1997	18-6410	90		F90	2003-2004	18-6425
30		C30ELD - C30MLHS	1990-1997	18-6410	90		F90	2006-2011	18-6427
30		CV30	1989-1990	18-6410	90	4	F90TJR	2006 & UP	18-6427
30		CV30ELF	1989	18-6410	90		F90TJRB - F90TJRC	2003-2004	18-6425
40		40	1984-1988	18-6422	90	4	F90TLR	2006 & UP	18-6427
40		40	1989-2005	18-6421	90		F90TLRB - F90TLRC	2003-2004	18-6425
40		40EJRQ	1992	18-6421	90	4	F90TXR	2006 & UP	18-6427
40		40EJRR - 40TLHV	1993-2001	18-6421	100		F100	1999-2003	18-6425
40	2	40TLR	2006 & UP	18-6421	100		F100TLRA - F100TXRZ	2001-2003	18-6425

APPLICATION CONTINUED ON NEXT PAGE

HP	Stroke	Model	Year	Starter	HP	Stroke	Model	Year	Starter
115		115	1984-1996	18-6413	175		VZ175TLRA - VZ175TLRZ	2001-2005	18-6426
115		115	2000-2009	18-6415	175		Z175	2001-2005	18-6426
115		115ETLD	1990	18-6413	175	2	Z175TXR	2006 & UP	18-6426
115		115ETLD-JD	1990	18-6413	175		Z175TXRA - Z175TXRZ	2001-2005	18-6426
115		115ETLF	1989	18-6413	200		200	1984-1996	18-6413
115		115ETLF-JD	1989	18-6413	200		200ETLD - 200TXRT	1984-1996	18-6413
115		115ETLG	1988	18-6413	200	4	F200TXR	2006 & UP	18-6833
115		115ETLG-JD	1988	18-6413	200		F200TXRA - F200TXRD	2002-2005	18-6833
115		115ETLH	1987	18-6413	200	4	F200XTR	2006 & UP	18-6833
115		115ETLH-JD	1987	18-6413	200		L200	1986-1996	18-6413
115		115ETLJ - 115TXRT	1984-1996	18-6413	200		L200ETF - L200TXRU	1986-1996	18-6413
115		C115	1991-1996	18-6413	200	4	LF200TXR	2006 & UP	18-6833
115		C115	2000	18-6415	200		LF200TXRA - LF200TXRD	2002-2005	18-6833
115		C115LXRQ - C115TXRU	1991-1996	18-6413	200		LX200	1999-2001	18-6415
115		F115	2000-2011	18-6427	200		LZ200	2002-2011	18-6426
115	4	F115TJR	2006 & UP	18-6427	200	2	LZ200TXR	2006 & UP	18-6426
115		F115TJRA - F115TJRD	2002-2005	18-6427	200		LZ200TXRA - LZ200TXRZ	2000-2005	18-6426
115	4	F115TLR	2006 & UP	18-6427	200		P200TLRS - P200TLRU	1994-1996	18-6413
115		F115TLRA - F115TLRZ	2001-2005	18-6427	200		S200	1996	18-6413
115	4	F115TXR	2006 & UP	18-6427	200		S200TXRU	1996	18-6413
115		F115TXRA - F115TXRZ	2001-2005	18-6427	200		SX200	1999-2005	18-6415
115		LF115	2000-2011	18-6427	200		V-200	1998-1999	18-6424
115	4	LF115TXR	2006 & UP	18-6427	200		V200TLRW - V200TLRX	1998-1999	18-6861
115		LF115TXRA - LF115TXRD	2002-2005	18-6427	200		VX200	2000-2003	18-6424
115		P115	1993-1996	18-6413	200		VX200TLRA - VX200TLRZ	2001-2003	18-6861
115		P115TLRR - S115TLRU	1993-1996	18-6413	200		VZ200	2001-2004	18-6426
130		130	1988-1996	18-6413	200		VZ200TLRA - VZ200TLRZ	2001-2004	18-6426
130		130	2000-2004	18-6415	200		Z200	2000-2011	18-6426
130		130ETLD - 130TXRT	1988-1995	18-6413	200	2	Z200TLR	2006 & UP	18-6426
130		L130	1989-1996	18-6413	200		Z200TLRD	2005	18-6426
130		L130	2000-2001	18-6415	200		Z200TLRY - Z200TLRZ	2000-2001	18-6426
130		L130ETXD - S130TXRU	1990-1996	18-6413	200	2	Z200TXR	2006 & UP	18-6426
150		150	1984-1996	18-6413	200		Z200TXRA - Z200TXRZ	2000-2005	18-6426
150		150	2000-2009	18-6415	225		225TUR	1995	18-6861
150		150ETLD - 150TXRT	1990-1997	18-6413	225		225TXRS	1994	18-6861
150		C150	1996	18-6413	225		225TXRT	1995	18-6861
150		C150TLRU	1996	18-6413	225	4	F225TUR	2006 & UP	18-6833
150		C150TXRU	1996	18-6413	225		F225TURA - F225TURD	2002-2005	18-6833
150		DX150	1999-2005	18-6415	225	4	F225TXR	2006 & UP	18-6833
150		L150	1986-1996	18-6413	225		F225TXRA - F225TXRD	2002-2005	18-6833
150		L150ETXD - L150TXRU	1986-1996	18-6413	225		L225	1994-1999	18-6424
150	4	LF150TXR	2006 & UP	18-6413	225		L225TUR - L225TXRX	1994-1999	18-6861
150		LX150	1999-2001	18-6415	225	4	LF225TUR	2006 & UP	18-6833
150		LZ150	2000-2005	18-6426	225		LF225TURA - LF225TURD	2002-2005	18-6833
150	2	LZ150TXR	2006 & UP	18-6426	225	4	LF225TXR	2006 & UP	18-6833
150		LZ150TXRA - LZ150TXRZ	2000-2005	18-6426	225		LF225TXRA - LF225TXRD	2002-2005	18-6833
150		Z150	2000-2005	18-6415	225		LX225	2000-2003	18-6424
150		P150	1991-1996	18-6413	225		LX225TXRA - LX225TXRZ	2000-2003	18-6861
150		P150TLRQ - P150TLRU	1986-1996	18-6413	225		S225	1996-1999	18-6424
150		PRO V-150	1986-1990	18-6413	225		S225TURU - S225TXRX	1996-1999	18-6861
150		S150	1996	18-6413	225		SX225	2000-2003	18-6424
150		S150TLRU / S150TXRU	1996	18-6413	225		SX225TURA - SX225TXRZ	2000-2003	18-6861
150		SX150	2000-2001	18-6415	225		V225	1998-1999	18-6424
150		V-150	2000-2008	18-6415	225		V225TLRW - V225TLRX	1998-1999	18-6861
150		VX150	2000-2004	18-6415	225		VX225	2000-2003	18-6424
150		VZ150	2000-2011	18-6426	225		VX225TLRA - VX225TLRZ	2000-2003	18-6861
150	2	VZ150TLR	2006 & UP	18-6426	250		250	1990-1995	18-6424
150		VZ150TLRA - Z150TLRZ	2000-2004	18-6426	250		250ETXD - 250TXRT	1990-1995	18-6861
150	2	Z150TXR	2006 & UP	18-6426	250		L250	1990-1999	18-6424
150		Z150TXRA - Z150TXRZ	2000-2004	18-6426	250		L250ETXD - L250TXRX	1990-1999	18-6861
175		175	1984-1995	18-6413	250		LX250	2000-2003	18-6424
175		175	2000	18-6415	250		LX250TURA - LX250TXRZ	2000-2003	18-6861
175		175ETLD - 175TXRT	1984-1995	18-6413	250		S250	1996-1999	18-6424
175		P175	1994-1996	18-6413	250		S250TURU - S250TXRX	1996-1999	18-6861
175		P175TLRS - P175TLRU	1994-1996	18-6413	250		SX250	2000-2003	18-6424
175		S175 / S175TXRU	1996	18-6413	250		SX250TURA - SX250TXRZ	2000-2003	18-6861
175		V-175	2000	18-6415			V-6 SPECIAL	1984-1986	18-6413
175		VZ175	2001-2011	18-6426			V-6 SPECIAL L	1984	18-6413
175	2	VZ175TLR	2006 & UP	18-6426			V-6SPECIAL X	1984	18-6413



18-50000
STARTER HANDLE
Replaces: 689-15755-01-00 + 6G1-15779-00-00
Fits: Yamaha 15 hp & Up (1988 & Up)



18-50001
STARTER HANDLE
Replaces: 6G1-15755-00-00, 6G1-15779-00-00
Fits: 2.5-9.9 hp(1988 & Up)



18-56002
BRUSH HOLDER ASSEMBLY
Replaces: 689-81840-11-00
Fits: F6/F8/T8 (2001-05), F9.9 (1985-90,1999-05), T9.9 (1991-97,1999,2001-05), 25 (1984-87)(1999-00), C25 (1991,1993-97), CV25 (1990), 30 (1984-01), C30 (1991-97), CV30 (1990), 40 (1984-05), P40 (1998), C40 (1991-01), CV40 (1990), 50 (1986-05), C50 (1998-01), P50 (1991-96), PRO50 (1987-90), 60 (2001-05), C60 (1996-01), P60 (1991-99), 70 (1984-05), C70 (2000-01)
Use with **18-6410** Starter



18-56004
BRUSH HOLDER ASSEMBLY
Replaces: 663-81840-11-00
Fits starters: 689-81800-13-00(**18-6410**), 6H3-81800-11-00 (**18-6410**), 6F5-81800-11-00,6J4-81800-01-00 (**18-6421**)
6H4-81800-12-00 (**18-6422**), 697-81800-12, 99999-03249-00-00 (**18-6412**)



18-56005
BRUSH HOLDER ASSEMBLY
Replaces: 6E5-81840-10-00
Fits starters: 689-81800-13-00(**18-6410**), 6H3-81800-11-00 (**18-6410**), 6F5-81800-11-00, 6J481800-01-00(**18-6421**), 6H4-81800-12-00 (**18-6422**), 6E5-81800-11-00, 6E5-81800-12-00 (**18-6413**)



18-56006
BRUSH HOLDER ASSEMBLY
Replaces: 6N7-81840-00-00
Fits: 115,130,150 HP (1997-04), 175,200 HP (1997-98), 225 HP (1997)
Use with **18-6415** Starter



18-56007
BRUSH HOLDER ASSEMBLY
Replaces: 61A-81840-00-00
Fits starters: 61A-81800-00-00, 61A-81800-01-00, 69L-81800-00-00 Fits:225 (1991-96), 250 (1990-95), L225 (1994-99), L250 (1990-99), LX225,LX250(2000-03), P150,P175 (1994-96, P200 1991-96, S225/S250 1996-99), SX225,SX250 (2000-03), V200/V225 (1998-99), VX200 (2000-05), VX225 (2000-04), VX250 (2002-04)



18-6798
TRIM MOTOR
Replaces: 69J-43880-00-00, 60V-43880-00-00
(O-Ring included)
Fits: F200, F225 (2004-06), F250 (2005-06), LF200, LF225, LF250, LZ200, LZ225, LZ250 (2004-06)



18-6748
TRIM MOTOR
Replaces: 67C-43880-00-00, 67C-43880-01-00
Fits: F30, F40 (2001 & Up)



18-6259
TILT/TRIM MOTOR
Replaces: 6H1-43880-00-00
(O-Ring Included)
Fits: 70/90HP (1987-91), C85/P60HP (1991)



18-6787
TILT/TRIM MOTOR
Replaces: 67F-43880-00-00
(O-Ring Included)
Fits: Yamaha 4-Stroke F75 (2003-04), F80 (1999-03), F90 (2003-04), F100 (1999-02)



18-6788
TILT/TRIM MOTOR
Replaces: 6H5-43880-02-00
(O-Ring Included)
Fits: Yamaha 40-50hp (1985-92)



18-6789
TILT/TRIM MOTOR
Replaces: 62X-43880-09-00
(O-Ring Included)
Fits: Yamaha 40-100hp (1995-03)



18-6760
TRIM MOTOR
Replaces: 6G5-43880-02-00
(O-Ring Included)
For: 115-200HP (1987-96)



18-6781
TILT/TRIM MOTOR
Replaces: 6H1-43880-02-00
2-wire connection, 3 bolt mount
For: 40HP (1994) 50HP (1992-95) 60HP (1997-up) 70HP (1996-up) 90HP (1992-up)



18-6782
TILT/TRIM MOTOR
 Replaces: 61A-43880-01-00,
 61A-43880-02-00
 3-bolt mount, 4 wire connection
 (O-Ring Included)
 For: 225-250HP



18-6783
TILT/TRIM MOTOR
 Replaces: 64E-43880-00-00, 64E-43880-01-00
 2-wire ring terminal connection 4-bolt mount
 (O-Ring Included)
 For: 115-225HP (1997-2002)



18-6811
POWER TRIM MOTOR
 Replaces: 62Y-43800-11-00, 62Y-43880-00-00,
 69W-43880-00-00
 (O-Ring included)
 Fits: 40(2003 & Up), 50(2003 & Up), C40(2003),
 F50(2003-04), T50(2003-04), 2002-04 60hp 4-stroke



18-6812
TRIM MOTOR
 Replaces: 62X-43880-00-00,
 62X-43880-01-00, 62X-43880-09-00
 Fits: 1995-03 Yamaha 40-100HP



18-6821
TRIM MOTOR
 Replaces: 688-43880-11-00,
 6E5-43880-01-00, -02-00
 Fits: Yamaha 50-200HP 1985-86



18-6836
TRIM MOTOR
 Replaces: 6C5-43880-00-00,
 6C5-43880-01-00
 Fits: 2005-06 F50 and F60



NEW

18-1522
RELAY, TRIM ASSEMBLY
 Replaces: 63P-81950-00
 Fits: 25-150, 200-225 HP (06-Up), 50-90, 250 HP (05-Up),
 150 HP (04-Up)



NEW

18-1523
RELAY, TRIM ASSEMBLY
 Replaces: 61A-81950-01
 Fits: F25 HP (98-Up), T25 HP (01-Up), 60 HP (93-Up), 70
 HP (93-Up), 75 HP (94-99), 80 HP (97), 85 HP (93-96), 90
 HP (93-09), 150 HP (99-05), 200 HP (98-05), 225 HP
 (90-04), 250 HP (90-04)



18-6823
WIRING HARNESS
 Converts 3-wire Tilt and Trim motors to
 2-Wire design



18-7484
BACK-UP RING
 Replaces: 65W-43871-00-00
 For: F25-F40 1999-2008 w/Power Trim



18-2083
FUEL INJECTOR SEAL
 Replaces: 68V-13766-00-00



TRIM SEALS

18-2081
 Replaces: 64E-43822-00-00

18-2082
 Replaces: 64E-4384J-00-00

















18-9802
TIMING LIGHT
 Self-powered accurate up to 10,000 RPM's



18-7058
CARBURETOR KIT
 Replaces: 63V-W0093-00-00
 Fits: 9.9(1996-09), 15(1996-09)



18-7059
CARBURETOR KIT
 Replaces: 677-W0093-00-00,
 677-W0093-04-00
 Fits: 9.9(1984-85), 15(1984-85)

 <p>18-7002 CARBURETOR KIT Replaces: 6E5-W0093-06-00 Fits: 115 (1986-88, 1992-93, 1995), 130 (1988, 1992-93, 1995), 150, 175 (1986-87, 1992-95), 200 (1986-87, 1992-95), 225 (1992-93)</p>	 <p>18-7290* CARB KIT Replaces: 696-W0093-02-00 *Kit contains enough components to rebuild 2 carburetors</p>	 <p>18-7291 CARB KIT Replaces: 6H1-W0093-01-00 (3) of 18-7291 = (1) of 6H1-W0093-01-00</p>	
 <p>18-7293 CARB KIT Replaces: 6A1-W0093-01-00</p>	 <p>18-7736 CARB KIT Replaces: 67D-W0093-00-00 For: (1999-02) F4</p>	 <p>18-7737 CARB KIT Replaces: 61N-W0093-00-00 For: (1993-97) C30</p>	
 <p>18-7738 CARB KIT Replaces: 66M-W0093-01-00, 66M-W0093-00-00 For: (1998-02) F15</p>	 <p>18-7739 CARB KIT Replaces: 6L2-W0093-00-00 For: (1996-97) 20 (1988-02) 25 3 cyl</p>	 <p>18-7740 CARB KIT Replaces: 6E9-W0093-02-00 For: (1990-94) C40 2 cyl</p>	
 <p>18-7741 CARB KIT Replaces: 6E9-W0093-03-00 For: (1995-98) C40 2 cyl</p>	 <p>18-7742 CARB KIT Replaces: 6H0-W0093-00-00 For: (1997) C80</p>	 <p>18-7743 CARB KIT Replaces: 67F-W0093-00-00 For: (1999-02) F80/F100</p>	 <p>18-7744 CARB KIT Replaces: 6N6-W0093-02-00 For: (1990-91) 115, 130, L130</p>
 <p>18-7747 CARB KIT Replaces: 6G5-W0093-08-00 For: (1985-86) 150/175/200, V6 Special</p>	 <p>18-7756 CARB KIT Replaces: 64D-W0093-00-00 For: (1996-01) 150/150L/175 (1996-99) 200/L200 (2000-01) 150/175 (1997-98) D150</p>	 <p>18-7759 CARB KIT Replaces: 6K7-W0093-09-00 For: (1990-91) 150/175/200 (1991-92) P200</p>	 <p>18-7765 CARB KIT Replaces: 6G1-W0093-00-00</p>

CARB KIT APPLICATION BEGINS ON PAGE 486



18-7766
CARB KIT
 Replaces: 6H3-W0093-02-00
 (3) of 18-7766 = (1) of 6H3-W0093-02-00



18-7767
CARB KIT
 Replaces: 6H4-W0093-01-00
 (3) of 18-7767 = (1) of 6H4-W0093-01-00



18-7768
CARB KIT
 Replaces: 6H4-W0093-03-00
 (3) 18-7768 = (1) 6H4-W0093-03-00



18-7769
CARB KIT
 Replaces: 6E7-W0093-04-00



18-7770
CARB KIT
 Replaces: 689-W0093-02-00



18-7772
CARB KIT
 Replaces: 61A-W0093-01-00, 61A-W0093-00-00
 For: (1991-96) 225/250 3.1 liter, L225, L250



18-34600
CARBURETOR
 Replaces: 66M-14301-00-00,
 66M-14301-12-00
 Fits: F15(2006 & Up)



18-34601
CARBURETOR
 Replaces: 67D-14301-13-00
 Fits: F4(2005 & Up)



18-34603
CARBURETOR
 Replaces: 63V-14301-00-00
 Fits: 9.9(1996-03), 15(1996-03)



18-34604
CARBURETOR
 Replaces: 69M-14301-11-00
 Fits: F2.5MSH(2006 & Up)



18-34605
CARBURETOR
 Replaces: 66T-14301-00-00
 Fits: T40/T30 Enduro Series



18-7049
NEEDLE VALVE
 Replaces: 62Y-14392-00-00, 61N-14392-00-00,
 6L2-14392-00-00
 Fits: C30(1993-97)



18-7054
NEEDLE VALVE
 Replaces: 6G1-14546-00-00, 6G1-14546-01-00
 Fits: 3(1988-02), 6(1986-00), 8(1984-03), 9.9(1996-03),
 15(1996-03), F25(1998-03), F30(2000-02), F40(2000-02),
 T25(2001-03)



18-7055
NEEDLE VALVE
 Replaces: 6E5-14546-00-00,
 6J8-14546-00-00
 Fits: 25 MLHV3(1997), 25MLHW3(1998),
 25 MSHV3(1997), 25 MSHW3(1998),
 30(1987-98), 115(1986-09), 130(1988-04),
 150(1986-09), 175(1986-95, 2000), 200(1986-98),
 225(1990-97), B115(1998-99), 250(1991-95),
 C115(1991-00), C150(1996-99), D150(1997-99),
 L130(1989-01), L150(1986-99), L200(1986-99),
 L225(1994-96), L250(1990-96), P115(1993-96),
 P150(1991-99), P175(1994-99), P200(1991-99),
 S115(1996-99), S130(1996-99), S150(1996-99),
 S175(1996-99), S200(1996-99), S225(1996),
 S250(1996), V150(2000-08), V175(2000)



18-7056
NEEDLE VALVE
 Replaces: 6H3-14590-00-00,
 6H3-14590-01-00, 67F1439A-00-00,
 6H2-14591-00-00
 Fits: 40(1984-92), 50(1984-92), 70(1984-01),
 C40(1991-94), C60(1996-01), C70(2000-01),
 CV40(1990), E60(1995-00), F80(2000-02),
 F100(2000-02), P50(1991-92), P60(1991-99)

 <p>18-7060 NEEDLE VALVE Replaces: 692-14590-00-00, 692-14590-01-00 Fits: 90(1984-02), B90(1997-99), C75(1994-99), C80(1997), C85(1991-96), C90(1997-01), CV85(1989-90), E75(1995-00), P75(1996-99)</p>	 <p>18-7073 NEEDLE VALVE Replaces: 6E8-14380-12-00, 6E7-14390-12-00 Fits: 9.9(1986-95), 15(1986-95)</p>	 <p>18-7079 NEEDLE VALVE Replaces: 626-14390-90 Fits: 9.9(1984-85), 15(1984-85)</p>	 <p>18-7063 FLOAT Replaces: 6L2-14385-00-00 Fits: 20(1996-97), 25(1988-09), C30(1993-97), F15(1989-06), F40(1999), F50(1995-03), F60(2002-04), F9.9(2005-06), T50(1996-04), T60(2003-04), T9.9(2005-06)</p>
 <p>18-7064 FLOAT Replaces: 63V-14985-00 Fits: 9.9(1996-09), 15(1996-09), F25(1998-13), F30(2001-05), F40(2000-08), T25(2001-13)</p>	 <p>18-7065 FLOAT Replaces: 647-14385-00-00 Fits: 4(1984-85), 5(1984-85), 9.9(1984-85), 15(1984-85)</p>	 <p>18-7066 FLOAT Replaces: 648-14385-00-00 Fits: 25(1984-87), 30(1984-86), C25(1991-97), C30(1991-92), Cv25(1990), CV30(1989-90)</p>	 <p>18-7067 FLOAT Replaces: 6G1-14985-00-00 Fits: 3(1988-02), 6(1986-00), 8(1984-00), 40(1984-88), 50(1984-88), 70(1984-91), C60(1996-01), E60(1995-00), PRO 50(1987-88), P60(1991)</p>
 <p>18-7068 FLOAT Replaces: 6E5-14385-01-00, 6E5-14385-00-00 Fits: 115(1984), 150(1984), 175(1984), 200(1984)</p>	 <p>18-7069 FLOAT Replaces: 6E5-14385-02-00 Fits: 115(1986-09), 130(1988-04), 150(1986-09), 175(1986-00), 200(1986-98), 200(1990-97), B115(1998-99), C115(1991-00), C150(1996-99), D150(1997-99), L130(1989-01), L150(1986-99), L200(1986-99), P115(1993-96), P150(1991-99), P175(1994-99), P200(1991-99), PRO150(1986-90), S115(1996-99), S130(1996-99), S150(1996-99), S175(1996-99), S200(1996-99), V150(2000-08), V6 Excel(1987-89), V6 Special(1986)</p>	 <p>18-7392 FLOAT Replaces: 676-14985-01-00 Fits: 90(1984-90), C40(1991-97), C75(1994-99), C80(1997), C85(1991-96), CV40(1990), CV85(1989-90), E75(1995-00)</p>	
 <p>18-7393 FLOAT Replaces: 6E7-14385-00-00 Fits: 4(1986-94), 5(1994), 9.9(1986-95), 15(1986-95)</p>	 <p>18-0710 FLOAT CHAMBER GASKET Replaces: 68V-14984-00 Fits: F115 (2000-10), LF115 (2000-10), F200 (2002-10), LF200(2002-10), F225(2002-05), LF225(2002-05), F225TXR models(2007-10), LF225TXR models(2007-10)</p>	 <p>18-0711 FLOAT CHAMBER GASKET Replaces: 66K-14984-00 Fits: DX 150(1999-05), LX 150(1999-01), LZ 150(2000-05), PX 150(1999), VX 150(2000-04), VZ 150(2000-10), Z 150(2000-05), VZ 175(2001-10), Z175(2001-05), LX200(1999-01), LZ200(2000-10), SX200(1999-05), V200(1999), VX200(2000-05), VZ200(2001-09), Z200 (2000-10), L225(1999), LX225(2000-03), S225(1999), SX225(2000-03), V225(1999), VX225(2000-04), VZ225(2003-09), L250(1999), LX250(2000-03), LZ250(2003-05), S250(1999), SX250(2000-03), VX250(2002-04), VZ250(2003-09), Z250(2003-05), LZ300(2004-06), VZ300(2004-09), Z300(2004-06)</p>	
 <p>18-0712 FLOAT CHAMBER GASKET Replaces: 63P-14984-00 Fits: F150 TLR (2004-10), F150 TXR (2004-10), LF150 TXR (2004-10)</p>	 <p>18-0713 FLOAT CHAMBER GASKET Replaces: 6P2-14984-00 Fits: F225TLR(2007-09), F250(2005-10), LF250(2005-10)</p>	 <p>18-0714 FLOAT CHAMBER GASKET Replaces: 6AW-14984-00 Fits: F300(2007-09), LF300(2007-09), F350(2007-10), LF350(2007-10)</p>	

CARB KIT APPLICATION BEGINS ON NEXT PAGE

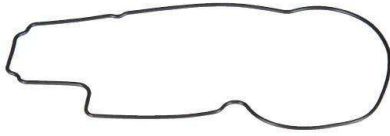

18-0715
FLOAT CHAMBER GASKET

Replaces: 65L-14984-00
Fits: V200(1998), L225(1997-98), S225(1997-98), V225(1998), L250(1997-98), S250(1997-98)

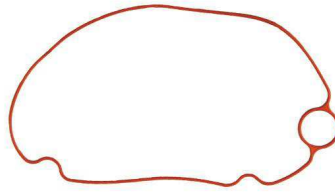

18-0716
FLOAT CHAMBER GASKET, VITON

Replaces: 6CB-14984-00
Fits: F115(2001-14), F200(2011-14), F225(2010-14), F250(2010-14), F300(2010-14), F350(2011-14), FL250(2010), FL300(2010), LF115(2011-14), LF200(2011-14), LF225(2010-14), LF250(2010-14), LF300(2010-14), LF350(2011-14), VF150(2013-14), VF200(2010-14), VF225(2010-14), VF250(2009-14)

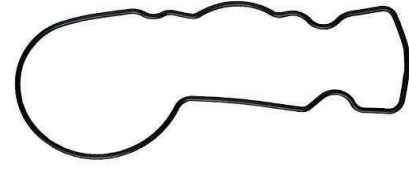

18-0717
FLOAT CHAMBER GASKET, VITON

Replaces: 6C5-14984-00
Fits: F50(2005-14), F60(2005-14), F70(2010-14), F75(2005-14), F90(2005-14), T50(2005-14), T60(2005-14)



18-99146
FLOAT CHAMBER GASKET

Replaces: 677-14384-01
Fits: 9.9(1984-95), 15(1984-95)



18-0707
SEAL, VITON

Replaces: 6CB-13016-00
Fits: F115(2011-14), F175(2014), F200(2011-14), F225(2010-14), F250(2010-14), F300(2010-14), F350(2012-14), FL250(2010), FL300(2010), LF115(2011-14), LF200(2011-14), LF225(2010-14), LF250(2010-14), LF300(2010-14), LF350(2012-14), VF150(2013-14), VF200(2010-14), VF225(2009-14), VF250(2009-14)

H.P.	Year	Carb Kit	Per Engine	Needle Valve Assy	Per Engine	H.P.	Year	Carb Kit	Per Engine	Needle Valve Assy	Per Engine
2	1984-88	18-7293	1			60	2001-02			18-7056	3
3	1988-02	18-7765	1	18-7054	1	C60	1996-01	18-7766	3	18-7056	3
F4	1999-02	18-7736	1			E60	1995-00	18-7766	3	18-7056	3
6	1986-96	18-7765	1	18-7054	1	P60	1991	18-7766	3	18-7056	3
6	1997-00		1	18-7054	1	P60	1992-99			18-7056	3
8	1984-96	18-7765	1	18-7054	1	70	1984-91	18-7766	3	18-7056	3
8	1997-00		1	18-7054	1	70	1992-01			18-7056	3
9.9	1984-85	18-7059	1	18-7079	1	C70	2000-01			18-7056	3
9.9	1986-95	18-7769	1	18-7073	1	C75	1994-97	18-7291	3	18-7060	3
9.9	1996-03	18-7058	1	18-7054	1	C75	1998-99	18-7742	3	18-7060	3
9.9	2004-09	18-7058	1			E75	1995-00	18-7291	3	18-7060	3
F9.9	2006	18-7738	1			P75	1996-99			18-7060	3
T9.9	2005-06	18-7738	1			C80	1997	18-7742	3	18-7060	3
15	1984-85	18-7059	1	18-7079	1	F80	1999-02	18-7743	3	18-7056	3
15	1986-92	18-7769	1	18-7073	1	C85	1991-96	18-7291	3	18-7060	3
15	1993-95		1	18-7073	1	CV85	1989-90	18-7291	3	18-7060	3
15	1996-03	18-7058	1	18-7054	1	90	1984-91	18-7291	3	18-7060	3
15	2004-09	18-7058	1			90	1992-02			18-7060	3
F15	1998-05	18-7738	1			B90	1997-99			18-7060	3
20	1996-97	18-7739	1			C90	1997-01			18-7060	3
25 (2 cyl)	1984-87	18-7770	1			F100	1999-02	18-7743	3	18-7056	3
25 (2 cyl)	1988-09	18-7739	1			115	1986-88, 1992-95	18-7002	2	18-7055	4
F25	1998-03		1	18-7054	1	115	1990-91	18-7744	2	18-7055	4
C25	1991-1997	18-7770	1			115	1992-09		2	18-7055	4
CV25	1990	18-7770	1			B115	1998-99			18-7055	4
T25	2001-03		1	18-7054	1	C115	1991			18-7055	4
30	1984-86	18-7770	1			C115	1992-95	18-7002	2	18-7055	4
30	1987-98		1	18-7055	1	C115	1996-00			18-7055	4
F30	2000-02		1	18-7054	1	P115	1993-96	18-7002	2	18-7055	4
C30	1991-92	18-7770	1			S115	1996-99			18-7055	4
C30	1993-97	18-7737	1	18-7049	1	130	1988, 1992-95	18-7002	2	18-7055	4
CV30	1989-90	18-7770	1			130	1990-91	18-7744	1	18-7055	4
40	1984-88	18-7767	3	18-7056	3	130	1992-04			18-7055	4
40	1989-92	18-7768	3	18-7056	3	L130	1989			18-7055	4
40	1993-05	18-7768	3			L130	1990-91	18-7744	1	18-7055	4
F40	2000-02			18-7054	3	L130	1992-95	18-7002	2	18-7055	4
C40	1991-93	18-7740	1	18-7056	2	L130	1996-01			18-7055	4
C40	1994-97	18-7741	1			S130	1996-99			18-7055	4
C40	2002-03	18-7768	3			150	1985-86	18-7747	1	18-7055	6
P40	1998	18-7768	1			150	1987, 1992-95	18-7002	3	18-7055	6
E48	1995-00	18-7290	2			150	1990-91	18-7759	1	18-7055	6
50	1984-88	18-7767	3	18-7056	3	150	1996-01	18-7756	3	18-7055	6
50	1989-92	18-7768	3	18-7056	3	150	2002-09			18-7055	6
50	1993 & Up	18-7768	3			C150	1996-99	18-7756	3	18-7055	6
C50	1998-01	18-7768	3			D150	1997-99	18-7756	3	18-7055	6
PRO 50	1987-88	18-7767	3			L150	1988, 1992-95	18-7002	3	18-7055	6
PRO 50	1989-90	18-7768	3			L150	1990-91	18-7759	1	18-7055	6
P50	1991-92	18-7768	3	18-7056	3	L150	1996-99	18-7756	3	18-7055	6
P50	1993-96	18-7768	3			Z150					
C55	1991-95	18-7290	2			P150	1991	18-7759	1	18-7055	6
CV55	1989-90	18-7290	2			P150	1992-95	18-7002	3	18-7055	6

① Kit contains enough components to rebuild 2 carburetors

APPLICATION CONTINUED ON NEXT PAGE

H.P.	Year	Carb Kit	Per Engine	Needle Valve Assy	Per Engine	H.P.	Year	Carb Kit	Per Engine	Needle Valve Assy	Per Engine
P150	1996-99	18-7756	3	18-7055	6	200	1996-98	18-7756	3	18-7055	6
PRO V150	1987	18-7002	3			L200	1988, 1992-95	18-7002	3	18-7055	6
PRO V150	1990	18-7759	1			L200	1990-91	18-7759	1	18-7055	6
S150	1996-99	18-7756	3	18-7055	6	L200	1996-99	18-7756	3	18-7055	6
V150	2000-01	18-7756	3			P200	1991	18-7759	1	18-7055	6
V150	2002-08			18-7055	6	P200	1993-95	18-7002	3	18-7055	6
175	1985-86	18-7747	2			P200	1996-99	18-7756	3	18-7055	6
175	1987, 1992-95	18-7002	3	18-7055	6	S200	1996-99	18-7756	3	18-7055	6
175	1990-91	18-7759	1	18-7055	6	V6 Special	1984-86	18-7747	2		
175	1992-95			18-7055	6	V6 Excel	1987-89	18-7759	1		
175	2000	18-7756	3	18-7055	6	225	1990-91	18-7759	1	18-7055	6
P175	1994-95	18-7002	3	18-7055	6	225	1992-95	18-7002	3	18-7055	6
P175	1996-99	18-7756	3	18-7055	6	225	1996-97	18-7756	3	18-7055	6
S175	1996-99	18-7756	3	18-7055	6	L225	1994-96	18-7772	6	18-7055	6
V175	2000	18-7756	3			S225	1996	18-7772	6	18-7055	6
200	1985	18-7747	2			250	1990-95	18-7772	6	18-7055	6
200	1986-87, 1992-95	18-7002	3	18-7055	6	L250	1991-96	18-7772	6	18-7055	6
200	1990-91	18-7759	1	18-7055	6	S250	1996	18-7772	6	18-7055	6

* Carb Kit contains enough componenets to rebuild 2 carburetors



18-35302
FUEL PUMP ASSEMBLY
Replaces: 66M-24410-10-00
Fits: F9.9(2005-06), T9.9(2005-06), F15(1998-06)



18-35304
FUEL PUMP ASSEMBLY
Replaces: 67D-24410-03-00
Fits: F4(2006-08)



18-7334
FUEL PUMP

Replaces: 692-24410-00-00, 663-24410-00-00, 6A0-24410-00-00, 6A0-24410-05-00, 6A0-24410-04-00, 6A0-24410-03-00, 6A0-24410-02-00, 6A0-24410-01-00
For: 2-Stroke 40 HP - 90 HP (1984-2009)
Uses Kit **18-7797**



18-7340
FUEL PUMP

Replaces: 68V-13907-03-00, 68V-13907-02-00, 68V-13907-01-00, 68V-13907-00-00
Fits: F115(2000-04, 2006-11), LF115(2000-11)



18-7341
FUEL PUMP

Replaces: 66K-13907-00-00
Fits: DX150(1999-01), LX150(1999-01), LX200(1999-01), LX225(2000-01), LX250(2000-01), PX150(1999), SX150(1999-01), SX200(1999-01), SX225(2000-01), SX250(2000-01), V200(1999), V225(1999), VX150(2000-01), VX200(2000-01), VX225(2000-01)



18-7342
FUEL PUMP

Replaces: 68F-13907-00, 68F-13907-01-00, 68F-13907-00-00
Fits: LZ150(2000-05), LZ200(2000-12), VZ150(2000-12), VZ175(2001-12), VZ200(2001-04), Z150(2000-05), Z175(2001-05), Z200(2000-12)



18-7343
FUEL PUMP

Replaces: 60V-13907-00-00
Fits: LZ250(2003-05), LZ300(2004-06), VZ200(2005-09), VZ225(2003-09), VZ250(2003-09), VZ300(2004-09), Z250(2003-05), Z300(2004-06)



18-7349
FUEL PUMP

Replaces: 6E5-24410-03-00, 6E5-24410-10-00, 6E5-24410-04-00, 6E5-24410-02-00, 6E5-24410-01-00, 6E5-24410-00-00
For: 2-Stroke 115 HP - 300 HP (1984-2004)
Uses Kit **18-7788**



18-7388
DIAPHRAGM

Replaces: 6G1-24411-00-00
Fits: 3(1988-02), 6(1986-00), 8(1984-09), 9.9(1996-09), 15(1996-09)



18-7389
DIAPHRAGM

Replaces: 6E0-24411-00-00
Fits: 4(1984-99), 5(1984-85, 1994-02)



18-7390
DIAPHRAGM

Replaces: 63V-24411-00-00
Fits: 9.9(1996-09), 15(1996-09)

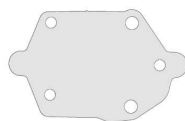

18-7391
DIAPHRAGM

Replaces: 692-24411-00-00
Fits: 40(1995-05), 50(1995-09), 60(2001-05), 70(1995-09), 90(1995-09), B90(1997-99), C25(1996-97), C30(1996-97), C40(1995-03), C50(1998-01), C55(1995), C60(1996-01), C70(2000-01), C75(1995-99), C80(1997), C85(1995-96), C90(1997-01), E48(1995-00), E60(1995-00), E75(1995-00), P40(1998), P50(1995-96), P60(1995-99), P75(1996-99)



18-7787
FUEL PUMP KIT

For: 40-90 HP

— CONTAINS —

Part #	Description	O.E.#
18-7840	Diaphragm (Front)	663-24411-00-00
18-7839	Diaphragm	648-24411-00-00



18-7788
FUEL PUMP KIT

Replaces: 6E5-24411-00-00
(V-4, V-6)

— CONTAINS —

Part #	Description	O.E.#
18-7843	Gasket (Rear)	6E5-24411-00-00
18-7842	Diaphragm (Top)	6E5-24471-00-00

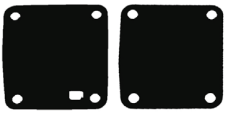

18-7367
FUEL PUMP KIT
Contains: 18-7833 & 18-7388

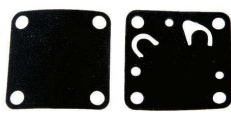

18-7368
FUEL PUMP KIT
Contains: 18-7834 & 18-7389

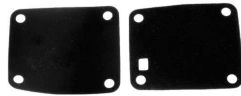

18-7369
FUEL PUMP KIT
Contains: 18-7388 & 18-7390



18-7797
FUEL PUMP KIT
Contains: 18-7839 & 18-7840



18-7798
FUEL PUMP KIT
Contains: 18-7838 & 18-7837



18-7799
FUEL PUMP KIT
Contains: 18-7842 & 18-7843



18-7833
FUEL PUMP DIAPHRAGM
Replaces: 6G1-24471-00-00



18-7834
FUEL PUMP DIAPHRAGM
Replaces: 6E0-24471-00-00



18-7837
FUEL PUMP DIAPHRAGM
Replaces: 677-24411-02-00



18-7838
FUEL PUMP DIAPHRAGM
Replaces: 677-24471-01-00



18-7839
FUEL PUMP DIAPHRAGM
Replaces: 648-24411-00-00



18-7840
FUEL PUMP DIAPHRAGM
Replaces: 663-24411-00-00



18-7841
FUEL PUMP DIAPHRAGM
Replaces: 6J8-24471-00-00



18-7842
FUEL PUMP DIAPHRAGM
Replaces: 6E5-24471-00-00



18-7843
FUEL PUMP DIAPHRAGM
Replaces: 6E5-24411-00-00

Model	Year	Diaphragms	Kits	Model	Year	Diaphragms	Kits	Model	Year	Diaphragms	Kits
3	1988-02	18-7833 / 18-7388	18-7367	E75	1995-00	18-7840		Z175	2001-01	18-7842	
4	1984-99	18-7834 / 18-7389	18-7368	P75	1996-99	18-7840		Z175	2002-04	18-7842 / 18-7843	18-7799
5	1984-85	18-7834 / 18-7389	18-7368	C80	1997	18-7840		200	1984-98	18-7842 / 18-7843	18-7799
5	1986-91	18-7834		85	1990	18-7798		L200	1986-99	18-7842 / 18-7843	18-7799
5	1994-02	18-7834 / 18-7389	18-7368	C85	1991-94	18-7839 / 18-7840	18-7797	LX200	1999-01	18-7842	
6	1986-00	18-7833 / 18-7388	18-7367	C85	1995-96	18-7840		LZ200	2000-01	18-7842	
8	1984-09	18-7833 / 18-7388	18-7367	CV85	1989-90	18-7839 / 18-7840	18-7797	LZ200	2002-04	18-7842 / 18-7843	18-7799
9.9	1984-95	18-7837 / 18-7838	18-7798	90	1984-94	18-7839 / 18-7840	18-7797	P200	1991-99	18-7842 / 18-7843	18-7799
9.9	1996-09	18-7388 / 18-7390	18-7369	90	1995-09	18-7840		S200	1996-99	18-7842 / 18-7843	18-7799
15	1984-95	18-7837 / 18-7838	18-7798	B90	1997-99	18-7840		SX200	1999-01	18-7842	
15	1996-09	18-7388 / 18-7390	18-7369	C90	1997-01	18-7840		SX200	2002-04	18-7842 / 18-7843	18-7799
20	1996-97	18-7837		115	1984-04	18-7842 / 18-7843	18-7799	V200	1999	18-7842	
25	1984-87	18-7840		B115	1998-99	18-7842 / 18-7843	18-7799	V200	1998	18-7842 / 18-7843	18-7799
25	1984-87			C115	1991-00	18-7842 / 18-7843	18-7799	VX200	2000-01	18-7842	
25	1988-09	18-7837		P115	1993-96	18-7842 / 18-7843	18-7799	VX200	2002-04	18-7842 / 18-7843	18-7799
C25	1991-95	18-7840	18-7797	S115	1996-99	18-7842 / 18-7843	18-7799	VZ200	2001	18-7842	
C25	1996-97	18-7840		I30	1988-04	18-7842 / 18-7843	18-7799	VZ200	2002-04	18-7842 / 18-7843	18-7799
CV25	1990	18-7839 / 18-7840	18-7797	C150	1996-99	18-7842 / 18-7843	18-7799	Z200	2000-01	18-7842	
25	1990	18-7837		L130	1989-99	18-7842 / 18-7843	18-7799	Z200	2002-04	18-7842 / 18-7843	18-7799
30	1984-86	18-7839 / 18-7840	18-7797	L130	2000-01	18-7842		225	1990-97	18-7842 / 18-7843	18-7799
30	1987-90	18-7841		S130	1996-99	18-7842 / 18-7843	18-7799	L225	1994-99	18-7842 / 18-7843	18-7799
30	1991-02	18-7841		150	1984-04	18-7842 / 18-7843	18-7799	LX225	2000-01	18-7842	
C30	1991-95	18-7839 / 18-7840	18-7797	D150	1997-99	18-7842 / 18-7843	18-7799	LX225	2002-03	18-7842 / 18-7843	18-7799
C30	1996-97	18-7840		L150	1986-99	18-7842 / 18-7843	18-7799	S225	1996-99	18-7842 / 18-7843	18-7799
CV30	1989-90	18-7839 / 18-7840	18-7797	LX150	1999-01	18-7842		SX225	2000-01	18-7842	
40	1984-94	18-7839 / 18-7840	18-7797	LZ150	2000-01	18-7842		SX225	2002-03	18-7842 / 18-7843	18-7799
40	1995-01	18-7840		LZ150	2002-04	18-7842 / 18-7843	18-7799	V225	1999	18-7842	
C40	1991-94	18-7839 / 18-7840	18-7797	DX150	1999-01	18-7842		V225	1998	18-7842 / 18-7843	18-7799
C40	1995-02	18-7840		DX150	2002-04	18-7842 / 18-7843	18-7799	VX225	2000-01	18-7842	
CV40	1990	18-7839 / 18-7840	18-7797	P150	1991-99	18-7842 / 18-7843	18-7799	VX225	2002-04	18-7842 / 18-7843	18-7799
P40	1998	18-7840		S150	1996-99	18-7842 / 18-7843	18-7799	VZ225	2003-04	18-7842 / 18-7843	18-7799
E48	1995-00	18-7840		SX150	1999-01	18-7842		250	1990-95	18-7842 / 18-7843	18-7799
50	1986-94	18-7839 / 18-7840	18-7797	SX150	2002-04	18-7842 / 18-7843	18-7799	L250	1990-99	18-7843	
50	1995-09	18-7840		V150	2000-01	18-7842		LX250	2000-01	18-7842	
C50	1998-01	18-7840		V150	2002-04	18-7842 / 18-7843	18-7799	LX250	2002-03	18-7842 / 18-7843	18-7799
P50	1991-94	18-7839 / 18-7840	18-7797	VX150	2000-01	18-7842		LZ250	2003-04	18-7842 / 18-7843	18-7799
P50	18-1995-96	18-7840		VX150	2002-01	18-7842 / 18-7843	18-7799	S250	1996-99	18-7842 / 18-7843	18-7799
55	1990	18-7798		VZ150	2000-04	18-7842		SX250	2000-01	18-7842	
C55	1991-94	18-7839 / 18-7840	18-7797	VZ150	2002-04	18-7842 / 18-7843	18-7799	SX250	2002-03	18-7842 / 18-7843	18-7799
CV55	1989-90	18-7839 / 18-7840	18-7797	Z150	2000-01	18-7842		VX250	2002-04	18-7842 / 18-7843	18-7799
60	2001-05	18-7840		Z150	2002-04	18-7842 / 18-7843	18-7799	VZ250	2003-04	18-7842 / 18-7843	18-7799
C60	1996-01	18-7840		PRO 150H	1987	18-7798		Z250	2003-04	18-7842 / 18-7843	18-7799
E60	1995-00	18-7840		I75	1984-95	18-7842 / 18-7843	18-7799	LZ300	2004	18-7842 / 18-7843	18-7799
P60	1991-94	18-7839		I75	1996-00	18-7842		VZ300	2004	18-7842 / 18-7843	18-7799
70	1984-94	18-7839 / 18-7840	18-7797	P175	1994-99	18-7842 / 18-7843	18-7799	Z300	2004	18-7842 / 18-7843	18-7799
70	1995-09	18-7840		S175	1996-99	18-7842 / 18-7843	18-7799	V6			
C70	2000-01	18-7840		V175	2000	18-7842		Special	1984-86	18-7842 / 18-7843	18-7799
C75	1994	18-7839 / 18-7840	18-7797	VZ175	2001	18-7842		V6 Excel	1987-89	18-7842 / 18-7843	18-7799
C75	1995-99	18-7840		VZ175	2002-04	18-7842 / 18-7843	18-7799				

**- UNIVERSAL DESIGN -
FUEL WATER SEPARATOR BRACKETS**



Bracket Type	Part #	Replaces	Bracket Type	Part #	Replaces
1/4" Stainless Steel	18-7777	MAR-FLTHD-SS-12	1/4" Aluminum	18-7853-1	MAR-FLTHD-AL-12
3/8" Stainless Steel	18-7776		3/8" Aluminum	18-7775	

FUEL WATER SEPARATOR KITS



**21 MICRON FILTER KITS
FOR CARBURETED ENGINES**

Kit Type	Part #	Micron Rating	Contents	Replaces
1/4" Aluminum (Short Filter)	18-7848-1 •	21	1 - 18-7844 filter & 1 18-7853-1 bracket 2 - 18-4256 1/4" pipe plugs	
1/4" Aluminum Bonus Pack Contains spare filter	18-7848-2	21	2 - 18-7844 filter & 1 18-7853-1 bracket 2 - 18-4256 1/4" pipe plugs	
1/4" Aluminum (Tall Filter)	18-7852-1	21	1 - 18-7845 filter & 1 18-7853-1 bracket 2 - 18-4256 1/4" pipe plugs	MAR-SEPAR-AT-OR
1/4" Aluminum Bonus Pack Contains spare filter	18-7852-2 •	21	2 - 18-7845 filter & 1 18-7853-1 bracket 2 - 18-4256 1/4" pipe plugs	
3/8" Aluminum (Tall Filter)	18-7775-1	21	1 - 18-7845 filter & 1 18-7775 bracket 2 - 18-4264 3/8" pipe plugs	
1/4" Stainless Steel (Tall Filter)	18-7777-1	21	1 - 18-7845 filter & 1 18-7777 bracket 2 - 18-4256 1/4" pipe plugs	ABB-SPRTR-HD-SS
3/8" Stainless Steel (Tall Filter)	18-7776-1	21	1 - 18-7845 filter & 1 18-7776 bracket 2 - 18-4264 3/8" pipe plugs	



**10 MICRON FILTER KITS
FOR FUEL INJECTED ENGINES**

Kit Type	Part #	Micron Rating	Contents	Replaces
1/4" Aluminum (Short Filter)	18-7983-1 •	10	1 - 18-7944 filter & 1 18-7853-1 bracket 2 - 18-4256 1/4" pipe plugs	
1/4" Aluminum Bonus Pack Contains spare filter	18-7983-2 •	10	2 - 18-7944 filter & 1 18-7853-1 bracket 2 - 18-4256 1/4" pipe plugs	
1/4" Aluminum (Tall Filter)	18-7982-1 •	10	1 - 18-7945 filter & 1 18-7853-1 bracket 2 - 18-4256 1/4" pipe plugs	
1/4" Aluminum Bonus Pack Contains spare filter	18-7982-2 •	10	2 - 18-7945 filter & 1 18-7853-1 bracket 2 - 18-4256 1/4" pipe plugs	
1/4" Aluminum (High Capacity Filter)	18-7966-1 •	10	1 - 18-7866 filter & 1 18-7853-1 bracket 2 - 18-4256 1/4" pipe plugs	MAR-SEPAR-AT-OR
3/8" Aluminum (Tall Filter)	18-7986-1	10	1 - 18-7945 filter & 1 18-7775 bracket 2 - 18-4264 3/8" pipe plugs	
1/4" Stainless Steel (Tall Filter)	18-7984-1 •	10	1 - 18-7945 filter & 1 18-7777 bracket 2 - 18-4256 1/4" pipe plugs	MAR-SPRTR-HD-SS
3/8" Stainless Steel (Tall Filter)	18-7985-1 •	10	1 - 18-7945 filter & 1 18-7776 bracket 2 - 18-4264 3/8" pipe plugs	

• Display Packaged



10 MICRON FILTER KITS WITH DRAIN BOWLS

Sierra AquaVue™ and metal bowl separator filters allow water to be drained from the filter to extend service life. Use the AquaVue™ bowl for outboard, above deck installations. USCG regulations require the use of the flame resistant metal bowl below deck.

• Display Packaged

Kit Type	Part #	Micron Rating	Contents
1/4" Aluminum w/ AquaVue™ bowl	18-7932-1 •	10	1 - 18-7919 filter & 1 18-7853-1 bracket 1 - 18-7922-1 AquaVue™ bowl 2 - 18-4256 1/4" pipe plugs
1/4" Aluminum w/ metal drain bowl	18-7951 •	10	1 - 18-7919 filter & 1 18-7853-1 bracket 1 - 18-7924 metal bowl 2 - 18-4256 1/4" pipe plugs
1/4" Stainless Steel w/ AquaVue™ bowl	18-7937-1 •	10	1 - 18-7919 filter & 1 18-7777 bracket 1 - 18-7922-1 AquaVue™ bowl 2 - 18-4256 1/4" pipe plugs
1/4" Stainless Steel w/ metal drain bowl	18-7938 •	10	1 - 18-7919 filter & 1 18-7777 bracket 1 - 18-7924 metal bowl 2 - 18-4256 1/4" pipe plugs

COMPACT BRACKET AND SEPARATOR KIT - FOR SMALL OUTBOARDS AND FRESH WATER APPLICATIONS

18-7774
COMPACT ALUMINUM BRACKET



18-7965-1 10 MICRON COMPACT SEPARATOR KIT

Replaces: MAR-MINIF-LT-AS

Contains:

- 1 - 18-7774 bracket
- 1 - 18-7865 filter



REPLACEMENT FILTERS



UNIVERSAL DESIGN - DIRECT REPLACEMENT FOR MERCURY AND YAMAHA

10 MICRON REPLACEMENT FILTERS

Part #	Description	Replaces
18-7944	Short - 3.875"	
18-7945	Long - 4.35"	ABB-FUELF-IL-TR
18-7866	High Capacity - 6"	MAR-FUELF-IL-TR
18-7865	Compact 10 Micron	MAR-MINIF-IL-TR

21 MICRON REPLACEMENT FILTERS

Part #	Description	Replaces
18-7844	Short - 3.875"	
18-7845	Long - 4.35"	ABB-FUELF-IL-TR



10 MICRON REPLACEMENT FILTERS AND KITS WITH DRAIN BOWLS

• Display Packaged

REPLACEMENT FILTERS

Part #	Description	Replaces
18-7919	Spin on replacement	MAR-24563-00-00 Racor S3213
18-7920	Spin on replacement	Racor S3214
18-7947	Spin on replacement • Fits - 120RRAC01	Racor S3240
18-7948	Spin on replacement • Fits - 320RRAC01	Racor S3227
18-7949	Spin on replacement • Fits - 660RRAC02	Racor S3232

REPLACEMENT FILTERS

Part #	Description	Replaces
18-7922-1	AquaVue™ Collection Bowl	
18-7924	Metal Collection Bowl	MAR-10171-00-10

FILTER & BOWL KITS

Part #	Description
18-7928-1 •	Filter & AquaVue™ Bowl • Mercury/Yamaha Style Contains: 18-7919 filter, 18-7922-1 bowl
18-7929 •	Filter & Metal Bowl • Mercury/Yamaha Style Contains: 18-7919 filter, 18-7924 bowl



18-8953
FUEL WATER
SEPARATOR COVER
Fits: Yamaha mini-10 size filter



18-8954
FUEL WATER
SEPARATOR COVER
Fits: Yamaha 18-7866 sized filter

 <p>18-7486 O-RING, FUEL FILTER BOWL Replaces: 61A-24564-00-00 Fits: V6</p>	 <p>18-7487 O-RING, FUEL FILTER ELEMENT Replaces: 65L-24564-00-00 Fits: V6</p>	 <p>18-7488 GASKET, FUEL FILTER BOWL Replaces: 6P3-24564-00-00 Fits: F/LF 150 - F300 (2006 - Current), VZ150 - VZ300 (2006 - Current), Z200 - Z300 (2006 - Current)</p>	 <p>18-7710-1 FUEL FILTER Replaces: 68T-24251-00-00 Fits: F6, F8 (2001 & Up)</p>									
 <p>18-7713 FUEL FILTER (INLINE) Replaces: 646-24251-02-00 Fits: 6 (1989, 1992-99), 8 (1989-99, 2001-02), F4 (1999-02), F9.9 (1989-95, 1997-99, 2001-02), FT 9.9 (1988-90)</p>	 <p>18-7780 FUEL FILTER Replaces: 6F5-24563-00-00 For: 9.9 - 225NR</p>	 <p>18-7781 FUEL FILTER Replaces: 61N-24563-00-00 For: 9.9/90° SX</p>	 <p>18-7782 FUEL FILTER Replaces: 61A-24563-00-00 For: V6, 3.1L, D-T</p>									
 <p>FUEL FILTERS</p> <table border="1"> <thead> <tr> <th>Part #</th> <th>Application:</th> </tr> </thead> <tbody> <tr> <td>18-7828-1</td> <td>1/4" Small Capacity (For 1/4" Fuel Line)</td> </tr> <tr> <td>18-7829</td> <td>1/4" Large Capacity (For 1/4" Fuel Line)</td> </tr> <tr> <td>18-7830</td> <td>5/16" Replaces: 65W-24251-10-00</td> </tr> <tr> <td>18-7831</td> <td>3/8"</td> </tr> </tbody> </table>	Part #	Application:	18-7828-1	1/4" Small Capacity (For 1/4" Fuel Line)	18-7829	1/4" Large Capacity (For 1/4" Fuel Line)	18-7830	5/16" Replaces: 65W-24251-10-00	18-7831	3/8"	 <p>18-7955 10 MICRON FUEL FILTER ELEMENT Replaces: 68F-24563-10-00 Fits: 150hp -300hp. (2004-2006) Models Z, VZ, LZ</p>	 <p>18-7979 FUEL FILTER Replaces: 68V-24563-00-00</p>
Part #	Application:											
18-7828-1	1/4" Small Capacity (For 1/4" Fuel Line)											
18-7829	1/4" Large Capacity (For 1/4" Fuel Line)											
18-7830	5/16" Replaces: 65W-24251-10-00											
18-7831	3/8"											
 <p>18-79799 FUEL FILTER Replaces: 6D8-WS24A-00-00 F50-F115 after April 2006 For filter housing marked "6D8" ONLY!</p>	 <p>18-79809 FUEL FILTER Replaces: 6P3-24563-01-00, 6P3-WS24A-00-00, 6P3-WS24A-01-00 F150, F200, F225, F250, Z-VZ 150 to 300 hp. after April 2006 For filter housing marked "6P3" ONLY!</p>	 <p>18-79905 10 MICRON FUEL FILTER Replaces: 69J-24501-10-00 Fits: F150 - F225 (2006 - Current), F250 - (2005 - Current)</p>										
 <p>18-79970 FUEL FILTER Replaces: 6BG-13915-00 Fits: F30(2013), F40(2008-13), F50(2005-13), F60(2005- 13), F70(2010-13), F75(2005-13), F90(2005-13), T50(2005-13), T60(2005-13)</p>	 <p>18-79972 ELEMENT, FILTER (CARB INLET) Replaces: 67F-14371-01 Fits: F75(2003-04), F80(2002-03), F90(2003-04), F100(2002-03)</p>	 <p>18-79973 FUEL FILTER Replaces: 6C5-13915-00 Fits: F50(2005-13), F60(2005-13), F70(2010-13), F75(2005-13), F90(2005- 13), T50(2005-13), T60(2005-13)</p>										



18-79977
FUEL FILTER

Replaces: 6L5-24251-00
Fits: 3(1992-02), F2.5(2003-12), F4(1999-08)



18-79979
FUEL FILTER

Replaces: 6CB-24501-00
F225 4.2L (2010), F250 4.2L (2010), F300 4.2L (2010), LF225 4.2L (2010), LF250 4.2L (2010), LF300 4.2L (2010), VF200 4.2L (2009-10), VF225 4.2L (2009-10), VF250 4.2L (2009-10)



18-79980
FUEL FILTER

REPLACES: 68F-24563-00
Fits: LZ150(2000-04), LZ200(2000-04), LZ250(2003-04), VZ150(2000-04), VZ175(2001-04), VZ200(2001-04), VZ225(2003-04), VZ250(2003-04), Z150(2000-04), Z175(2001-04), Z200(2000-04), Z250(2003-04)



18-79981
FUEL FILTER

Replaces: 69J-24501-00
Fits: F150(2004-05), F200(2002-05), F225(2002-05), LF150(2004-05), LF200(2002-05), F225(2002-05)



18-79982
FUEL FILTER

Replaces: 69J-24502-00
Fits: F150(2005-14), F200(2005-10), F225(2005-10), F75(2005-14), F90(2005-14), FL150(2010), LF150(2005-14), LF200(2005-10), LF225(2005-10)



18-79983
FUEL FILTER

Replaces: 6C5-24251-00
Fits: F115(2014-15), F30(2013-15), F40(2008-15), F50(2005-15), F60(2005-15), F70(2010-15), F75(2005-15), F90(2005-15), LF115(2014-15), T50(2005-15), T60(2005-11), VF115(2015)



18-79984
FUEL FILTER

Replaces: 6AW-24502-10, 6AW-24502-00-00
Fits: 2007-09, F350(2007-11), FL350(2010), LF300(2007-09), LF350(2007-11)



18-79985
FUEL FILTER

Replaces: 68V-24502-30, 68V-24502-20-00
Fits: F115(2010-11), LF115(2010-11)



18-79986
FUEL FILTER

Replaces: 68V-24502-02, 68V-24502-01-00
68V-24502-00-00
Fits: F115(2005-09), LF115(2005-09)



18-79907
VST FILTER

Replaces: 60V-24251-01-00
Fits: LZ150(2005), VZ150(2005-10), Z150(2005), VZ175(2005-10), Z175(2005), LZ200(2005-10), VZ200(2005-09), Z200(2005-10), VZ225(2005-09), LZ250(2005), VZ250(2005-09), Z250(2005), LZ300(2005-06), VZ300(2005-09), Z300(2005-06)



18-79900
VST FILTER (TAN)

Replaces: 66K-13915-00-00
Fits: DX150 (1999-05), LX150 1999-01, PX150 (1999), SX150 (1999-04), VX150 (2000-04), LX200 (1999-01), SX200 (1999-05), V200 (1999), VX200 (2000-05), L225 (1999), LX225 (2000-03), S225 (1999), SX225 (2000-03), V225 (1999), VX225 (2000-04), L250 (1999), LX250 (2000-03), SX250 (2000-03), VX250 (2002-04)



18-79901
VST FILTER (BLUE)

Replaces: 65L-13915-00-00
Fits: L225 (1997-98), S225 (1997-98), L250 (1997-98), V200 (1998), V225 (1998)



18-79902
VST FILTER

Replaces:
63P-13915-00-00
Fits: F150 TXR(2004-09), F150 TLR(2004-09), F150 TJR(2009), LF150 TXR(2004-09), F250 TXR(2005-09), F250 TUR(2005-09), F300 TXR(2007-09), F350 TXR(2007-09), F350 TUR(2007-09), F225TLR (2007-09)



18-79903
VST FILTER

Replaces:
68V-13915-00-00
Fits: F115 (2000-09), F200 TXR(2002-09), LF200 TXR(2002-09), F225 TXR(2002-09), F225 TUR(2002-09)



18-79904
VST FILTER (YELLOW)

Replaces:
68F-13915-00-00
Fits: HPDI 150(2000-05), V-Max HPDI 150(2000-09), V-Max HPDI 175(2001-09), HPDI 200(2000-09), HPDI 225(2003-09), HPDI 250 (2003-09), HPDI 300(2004-09)



18-79978
VST FILTER

Replaces: 6CB-13915-00
Fits: F225 4.2L (2010), F250 4.2L (2010), F300 4.2L (2010), LF225 4.2L (2010), LF250 4.2L (2010), LF300 4.2L (2010), VF200 4.2L (2009-10), VF225 4.2L (2009-10), VF250 4.2L (2009-10)



18-79910
FUEL FILTER ASSEMBLY

Replaces: 61N-24560-00, 61N-24560-10
Fits: 15(1994-09), 20(1996-97), 25(1994-09), 30(1995-01), 40(1994-05), 50(1994-09), 60(2001-05), 70(1994-09), 9.9(1994-09), 90(1994-09), B90(1997-99), C25(1994-97), C30(1994-97), C40(1994-03), C50(1998-01), C55(1994-95), C60(1996-01), C75(1994-99), C80(1997), C85(1994-96), C90(1997-01), E48(1995-00), E60(1995-00), E75(1995-00), F15(2005-10), F20(2006-10), F25(2005, 2009-10), F40(1999), F50(1995-04), F9.9(2005-06)



18-79950
VST KITS

Replaces: Kit 1
Fits: F150(04-12), LF150(04-12)

— CONTAINS —

Part #	Description	O.E. #
18-79902	VST Filter	63P-13915-00-00
18-79905	Fuel Filter, 10 Micron	68J-24501-10-00
18-0712	Float Chamber Gasket	63P-14984-00-00



18-79951
VST KITS

Replaces: Kit 2
Fits: F115(00-11), F200(02-10), F225(02-06), F225TXR(07-10), LF115(00-11), LF200(02-10), LF225(02-06), LF225 TXR(07-10)

— CONTAINS —

Part #	Description	O.E. #
18-79903	VST Filter	68V-13915-00-00
18-0710	Float Chamber Gasket	68V-14984-00-00



18-79952
VST KITS

Replaces: Kit 3
Fits: DX150(99-05), L225(99), L250(99), LX150(99-01), LX200(99-01), LX225(00-03), LX250(00-03), PX150(99), S225(99), S250(99), SX150(99-04), SX200(00-05), SX225(00-03), SX250(00-03), V200(99), V225(99), VX150(00-04), VX200(00-05), VX225(00-04), VX250(02-04)

— CONTAINS —

Part #	Description	O.E. #
18-79900	VST Filter	66K-13915-00-00
18-0711	Float Chamber Gasket	66K-14984-00-00



18-79953
VST KITS

Replaces: Kit 4
LZ150(00-05), LZ200(00-11), LZ250(03-05), LZ300(04-06), VZ150(00-11), VZ175(01-11), VZ200(01-09), VZ225(03-09), VZ250(03-09)VZ300(04-09), Z150(00-05), Z175(01-05), Z200(00-11), Z250(03-05), Z300(04-06)

— CONTAINS —

Part #	Description	O.E. #
18-79904	VST Filter	68F-13915-00-00
18-0711	Float Chamber Gasket	66K-14984-00-00



18-79954
VST FILTER & GASKET KIT

Fits: F225TLR (2007-2009, F250 (2005-2010), LF250 (2005-2010)

— CONTAINS —

Part #	Description	O.E. #
18-79902	VST Filter	63P-13915-00-00
18-0713	Float Chamber Gasket	6P2-14984-00-00



18-79955
VST FILTER & GASKET KIT

Fits: F300 (2007-2009), LF300 (2007-2009), F350 (2007-2010), LF350 (2007-2010)

— CONTAINS —

Part #	Description	O.E. #
18-79902	VST Filter	63P-13915-00-00
18-0714	Float Chamber Gasket	6AW-14984-00-00



18-79956
VST FILTER & GASKET KIT

Fits: F115 (2001-2014), F200 (2011-2014), F250 (2010-2014), F300 (2010-2014), F350 (2011-2014), FL250 (2010), FL300 (2010), LF115 (2011-2014), LF200 (2011-2014), LF225 (2010-2014), LF250 (2010-2014), LF300 (2010-2014), LF350 (2011-2014), VF150 (2013-2014), VF200 (2010-2014), VF225 (2010-2014), VF250 (2009-2014)

— CONTAINS —

Part #	Description	O.E. #
18-79902	VST Filter	63P-13915-00-00
18-0716	Float Chamber Gasket, Viton	6CB-14984-00-00



18-79957
VST FILTER & GASKET KIT

Fits: F50 (2005-2014), F60 (2005-2014), F70 (2010-2014), F75 (2005-2014), F90 (2005-2014), T50 (2005-2014), T60 (2005-2014)

— CONTAINS —

Part #	Description	O.E. #
18-79973	Fuel Filter	6C5-13915-00-00
18-0717	Float Chamber Gasket, Viton	6C5-14984-00-00



18-2083
FUEL INJECTOR SEAL

Replaces:
68V-13766-00-00



18-7655
OXYGEN SENSOR
Replaces: 67H-8592A-01-00,
67H-8592A-00-00
Fits: PX150 (1999), DX150 (99-05),
LX150, LX200 (99-01), VX150 (00-04)



18-7656
OXYGEN SENSOR
Replaces: 68F-8592A-00-00
Fits: L225, L250 (98-99), LX225, LX250 (00-03), LZ150
(00-05), LZ200 (00-12), S225, S250 (97-99), SX150 (99-
04), SX200 (99-05), SX225, SX250 (00-03), V200, V225
(98-99), VX200 (00-05), VX225 (98-05), VX250 (02-04),
VZ150 (00-14), VZ175 (01-12), VZ200 (01-04), Z150
(00-05), Z175 (01-05), Z200 (00-12)



18-7606
WATER SENSOR PROBE
Replaces: MAR-10171-30-00

8' LENGTH COMPLETE FUEL LINE ASSEMBLIES

3/8" FUEL LINE ASSEMBLY

18-8017EP-2 SILVERADO 4000 Premium

OE# 6YL-24306-60-00



18-8077-1
TANK CONNECTOR
(SOLD SEPARATELY)



18-8076
FUEL CONNECTOR

18-8005EP-1
PRIMER BULB

18-8076
FUEL CONNECTOR



*



FUEL LINE ASSEMBLY COMPONENTS
Fits: F75-F250 and 115-300 HP

3/8" FUEL LINE ASSEMBLY

18-8017S-1 SILVERADO 4000 Premium

OE# 6YL-24306-60-00



18-8077-1
TANK CONNECTOR
(SOLD SEPARATELY)



18-80415
FUEL CONNECTOR

18-8005S
PRIMER BULB

18-80415
FUEL CONNECTOR



*



FUEL LINE ASSEMBLY COMPONENTS
Fits: F75-F250 and 115-300 HP



PRIMER BULBS

18-8002EP-1
18-8002EP-1-10①
PRIMER BULB
1/4"

18-8005EP-1
18-8005EP-1-10①
PRIMER BULB
3/8"

18-8004EP-1
18-8004EP-1-10①
PRIMER BULB
5/16"

Replaces: 174512
Large capacity bulb

Large capacity bulb



18-8040
FUEL TANK ELBOW
Universal Fitting with
1/4" NPT Threads
Replaces: ABA-FBARB-90-DG
(Brass)



18-8055
HOSE BARB
1/4" NPT threads for connection of 5/16" I.D.
hose
Replaces: ABA-FLINE-BA-RB
(Brass)



18-8077-1
18-8077-1-10①
TANK CONNECTOR
(1/4" NPT)
Fits: F75-F250 and 115-300HP
Mates with **18-80413**, **18-80414**, **18-80415**





18-80413 FUEL CONNECTOR
1/4"
Replaces: 6Y1-24305-06-00, 6Y1-24305-04
Mates with **18-8077-1**



18-80414 FUEL CONNECTOR
Replaces: 6G1-24305-05-00, 6G1-24305-04
Fits: 6(1989, 1992-93), 8(1984-85, 1989-93, 2001-02), 9.9(1984-93, 2000-03), 15(1984-93, 2000-03), 25(1984-85, 1988-93, 2000-03), 30(1984-87, 1989-93, 1999, 2001-02), 40(1984-86, 1988-90, 1992-93, 2000-03), 50(1986-93, 2000-03), 60(2001-03), 70(1984-93, 2000-03), 90(1984-93, 2000-03), C25(1991, 1993), C30(1991-93), C40(1991-93, 2000-02), C50(2000-01), C55(1991-93), C60(2000-01), C70(2000-01), C85(1991-93), C90(2000-01), E48(2000), F6(2001-03), F8(2001-03), F9.9(1985-93, 2001-03), F15(1998-99, 2000-01), F25(1998-99, 2000-03), F30(2001-03), F40(1999, 2000-03), F50(1999, 2000-03), F60(2002-03), T8(2001-03), T9.9(1991-93, 1999, 2001-03), T25(2001-03), T50(1999, 2000-03), T60(2003)
Use with Yamaha 6mm fuel line
Mates with **18-8077-1**



18-80415 FUEL CONNECTOR
Replaces: 6E5-24305-05, 6Y2-24305-05
Use with Yamaha 8mm fuel line
Mates with **18-8077-1**

18-9145 OETIKER CLAMP KIT
Replaces: YB-6AW04-A



Part #	Qty.	Yamaha #	Oetiker #	Description	
18-9141	1	YB-6AW04-4	14100082	Oetiker Jaw Pincers	
Part #	Qty.	Yamaha #	Oetiker #	Nominal ID	
				Inches	mm
18-9133-9	50	YB-6AW04-1	16700016	5/8"	15.7
18-9146-9	50	YB-6AW04-3	16702498	25/32"	19.8

All clamps are standard package of 10. Each Package of 10 is available individually.

* Tanks and Engines for picture purpose only. ① Discount shop pack of 10 - Priced per package

 <p>18-3040 IMPELLER Replaces: 63V-44352-01-00</p>	 <p>18-3042 IMPELLER Replaces: 67F-44352-00-00</p>	 <p>18-3063 IMPELLER Replaces: 662-44352-01-00</p>	 <p>18-3065 IMPELLER Replaces: 6L2-44352-00-00</p>
---	---	--	---

 <p>18-3066 IMPELLER Replaces: 6G1-44352-00-00</p>	 <p>18-3067 IMPELLER Replaces: 689-44352-02-00</p>	 <p>18-3068 IMPELLER Replaces: 6H4-44352-02-00</p>	 <p>18-3069 IMPELLER Replaces: 6H3-44352-00-00</p>	 <p>18-3070 IMPELLER Replaces: 688-44352-03-00</p>
--	--	--	--	--

 <p>18-3071 IMPELLER Replaces: 6E5-44352-01-00</p>	 <p>18-3072 IMPELLER Replaces: 646-44352-01-00</p>	 <p>18-3073 IMPELLER Replaces: 6E0-44352-00-00</p>	 <p>18-3074 IMPELLER Replaces: 682-44352-01-00</p>	 <p>18-3088 IMPELLER Replaces: 6F5-44352-00-00</p>
--	--	--	--	--



18-45617-1
IMPELLER
 Replaces: 6CE-44352-00-00
 Fits: F225-F350, FL250-FL350 & VF250 Engines



18-8910
IMPELLER
 Replaces: 68T-44352-00-00



18-8911
IMPELLER
 Replaces: 6L5-44352-00-00



18-8925
IMPELLER
 Replaces: 6AW-44352-00-00



18-3185
WATER PUMP HOUSING
 Replaces: 61N-44311-01-00,
 61N-44311-00-00



18-43263
WATER PUMP HOUSING
 Replaces: 68D-G4311-01-00



18-3170
WATER PUMP HOUSING
 Replaces: 6E5-44311-00-00



18-3173-1
WATER PUMP HOUSING
 Replaces: 61A-44311-00-00,
 61A-44311-01-00



18-3171
WATER PUMP HOUSING
 Replaces: 688-44311-01-00



18-3356
WATER PUMP HOUSING
 Includes Impeller Cup
 Replaces: 63V-44301-00-00
 Fits: Two-Stroke: 9.9hp-15hp (1996-Current), Four-Stroke:
 6hp-8hp (2001-Current); 9.9hp. (2006-Current); 15hp
 (1998-Current)



18-3482
WATER PUMP HOUSING
 Replaces: 6CE-44311-01-00



18-3486
WATER PUMP HOUSING
 Replaces: 6L2-44311-01-00
 Fits: F25C (2016-17)

NEW



NEW

18-3483
WATER PUMP HOUSING
 Replaces: 6AW-44311-01-00
 Fits: F300, LF300 (2007-09), F350A, LF350A (2010-11),
 F350B, LF350B (2012-15), F350C, LF350C (2016-18), FL350
 (2010)



NEW

18-3484
WATER PUMP HOUSING
 Replaces: 6AW-44311-01-00
 Fits: F15C, F20 (2006-17)



NEW

18-3485
WATER PUMP HOUSING
 Replaces: 6CJ-44311-00-00
 Fits: F70A (2010-17)



18-4567
WATER PUMP HOUSING
Replaces: 6AH-44311-00
Fits: F4 (2009-17), F6 (2009-17)



18-9081
WATER PUMP HOUSING COVER
Replaces: 6E5-44312-00-00
Fits: 75 (2017), 90 (2016-2017), 115 (1984-2017), 130 (1988-2004), 150-250 (1984-2017), 250 (1990-2017), 300 (2004-2009)



18-9082
WATER PUMP HOUSING COVER
Replaces: 6AW-44312-00-00
Fits: F225 (2010-15), F250 (2010), F250 (2010-15), F300 (2007-15), F350 (2007-15), FL250 (2010), FL300 (2010), FL350 (2010), LF225 (2010-15), LF250 (2010-15), LF300 (2007-15), LF350 (2007-15), VF250 (2015)

PKG. OF 2



18-43716
IMPELLER PIN
Replaces: 93604-18080-00
Fits: 3(1988-02), 4(1984-99), 5(1984-01), F2.5(2003-14), F4(1999-14), F6(2009-14)

IMPELLER KEYS

Part No.	OE No.
18-3297	90280-03M03-00
18-3305	90280-03024-00, 90280-03003-00
18-3300	90280-04M00-00
18-3301	90280-04M04-00
18-3302	90280-04M05-00



BOLTS



Part No.	OE No.	Application
18-0256	97095-08045-00 97080-08045-00	8-1.25 x 45mm F6 (2001-05), F8 (2001-05) M8-1.25x45mm 18-8S/S
18-2605	90119-08M87-00	F80 (1999-03), F90 (2003-04), F100 (1999-02) M8-1.25x75mm 18-8 S/S
18-2606	90119-08M13-00	F80 (1999-03), F90 (2003-04), F100 (1999-02) M8-1.25x50mm 18-8 S/S
18-2607	97095-06040-00	For: 3HP (1988-99, 2002) M8-1.0x40mm 18-8 S/S
18-8400-9 ^{①②}	90119-08M15-00	8-1.25 x 29mm



18-9079
WAVE WASHER KIT
Replaces: 61A-45538-00-00 + 61A-45527-00-00 + 90206-22M19 + 90201-22M01
Fits: Yamaha 2-stroke 115-300hp (1993 & Up); Yamaha 4-stroke 115-225hp (2002 & Up); Mercury 4-stroke 225 EFI S/N 0T653945 & Up

— CONTAINS —

Part #	Desc.	O.E.#	Qty.
18-9075	Spacer	61A-45538-00-00	1
18-9076	Collar	61A-45527-00-00	1
18-9077	Wave Washer	90206-22M19-00	1
18-9078	Stainless Steel Washer	90201-22M01-00	2



18-1828
WATER DAMPER SEAL
Replaces: 663-44366-00
Fits: F30 (2013-17), F40A (2008-17)



18-1836
WATER DAMPER SEAL
Replaces: 6L2-44367-00
Fits: F15C, F20 (2006-17)



18-1837
WATER DAMPER SEAL
Replaces: 6L2-44367-10
Fits: F25C (2016-17)



18-1840
WATER DAMPER SEAL
Replaces: 6EE-G4366-00
Fits: F2.5 (2015-17)



18-1829
WATER SEAL DAMPER
Replaces: 6AW-44365-00-00
Fits: F225 (2010-15), F250 (2010), F250 (2010-15), F300 (2007-15), F350 (2007-15), FL250 (2010), FL300 (2010), FL350 (2010), LF225 (2010-15), LF250 (2010-15), LF300 (2007-15), LF350 (2007-15), VF250 (2015)

18-1830
WATER SEAL DAMPER

Replaces: 663-44366-00
Fits: 25 ML, MS(1997-02), 30(1987-01), 40(1984-05), 50(1986-09), 60(2001-05), 70(1984-09), 90(1984-09), B90(1997-99), C30(1995), C40(1991-01), C50(1998-01), C55(1991-95), C60(1996-01), C70(2000-01), C75(1994-99), C80(1997), C85(1991-96), C90(1997-01), E48(1995-00), E60(1995-00), E75(1995-00), F30(2001-05, 2013), F40(1999-13), F50(1995-13), F60(2002-13), F70(2010-13), F75(2003-11), F80(1999-03), F90(2003-13), F100(1999-03), F200(2002-12), F225(2002-12), F250(2005-12), L225(1994-99), L250(1990-99), LF200(2002-12), LF225(2002-10), LF250(2005-12), LX225(2000-03), LX250(2000-03), LZ250(2003-05), LZ300(2004-06), P40(1998), P50(1991-96), P60(1991-99), P75(1996-99), S225(1996-99), S250(1996-99), SX225(2000-03), SX250(2000-03), T25(2001-13), T50(1996-13), T60(2003-13), V200(1998-99), V225(1998-99), VX200(2000-05), VX225(2000-04), VX250(2002-04), VZ200(2005-09), VZ225(2005-09), VZ250(2003-09), VZ300(2004-09), Z250(2003-05), Z300(2004-06)



18-1831
WATER SEAL DAMPER

Replaces: 682-44366-00
Fits: 9.9(1984-95), 15(1984-95)



18-1832
WATER SEAL DAMPER

Replaces: 682-44367-00
Fits: 9.9(1984-95), 15(1984-95)



18-1833
WATER SEAL DAMPER

Replaces: 647-44366-00
Fits: 6(1986-00), 8(1984-00), 9.9(1996-09), 15(1996-09), F9.9(2005-06), F15(1998-06), T9.9(2005-06)



18-1834
WATER SEAL DAMPER

Replaces: 682-44365-00
Fits: 6(1986-00), 8(1984-00), 9.9(1996-09), 15(1996-09), F9.9(2005-06), F15(1998-06), T9.9(2005-06)



18-1835
WATER SEAL DAMPER

Replaces: 6E5-44365-00-00
Fits: 75 (2017), 90 (2016-2017), 115 (1984-2017), 130 (1988-2004), 150-250 (1984-2017), 250 (1990-2017), 300 (2004-2009)



18-3505
WATER SEAL DAMPER

Replaces: 63V-44365-10-00
Fits: 2-Stroke: 9.9hp & 15hp 1997-Current
4-Stroke: F6 & F/T8 2001-Current; F/T 9.9 2005-Current; F15 1998-Current



18-3166
WATER SEAL DAMPER

Replaces: 6E0-44366-00-00
For: 2 (1984-85, 88-99, 2002), 3 (1988-99, 02), 4 (1984-85, 88-99), 5 (1984-85, 95-02), F2.5 (2003-05)



18-3176
WATER SEAL DAMPER

Replaces: 68T-44366-00-00
For: F6, F8 (2001-05), C30 (1993-97)



18-3148
WATER PUMP KIT

Without Housing
Replaces: 682-W0078-A1-00

— CONTAINS —

Part #	Desc.	O.E.#	Qty.
18-0768	Gasket, Water Pump	682-44315-A0-00	2
18-2607	Bolt	97095-06045-00	4
18-3074	Impeller	682-44352-01-00	1
18-3297	Key, Impeller	90280-03024-00	1
NSS	Grommet	682-44365-00-00	1
NSS	Cup, Insert	682-44322-00-00	1
NSS	Plate, Wear	682-44323-00-00	1



18-3411
WATER PUMP KIT W/HOUSING

Replaces: 682-W0078-A1, 682-44300-01
For: 9.9(1984-95), 15(1984-95), F9.9(1985-96), FT9.9(1985-90), T9.9(1991-96)

— CONTAINS —

Part #	Desc.	O.E.#	Qty.
18-0768	Gasket, Water Pump	682-44315-A0-00	2
18-2607	Bolt	97095-06040-00	4
18-3074	Impeller	682-44352-01-00	1
18-3297	Key, Impeller	90280-03M03-00	1
NSS	Seal, Water	682-44365-00-00	1
NSS	Cup, Insert	682-44322-00-00	1
NSS	Plate, Wear	682-44323-00-00	1
NSS	Housing, Water Pump	682-44300-01-00	1

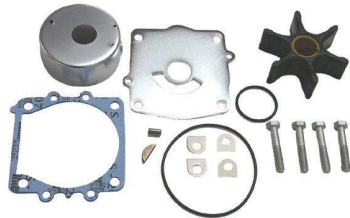

18-3310
WATER PUMP KIT

Without Housing
Replaces: 6G5-W0078-01-00

— CONTAINS —

Part #	Description	O.E.#	Qty.
18-0244	Gasket, Water Pump	6E5-44315-00-00	1
18-0256	Bolt	97395-08045-00-00	4
18-3071	Impeller	6E5-44352-00-00	1
18-3302	Key, Impeller	90280-04M05-00	1
18-3345	Plate, Wear	6G5-44323-00-00	1
18-7483	O-Ring, Water Pump	93210-37M67-00	1
18-7485	O-Ring, Water Pump	93210-86M38-00	1
NSS	Cup, Insert	6E5-44322-00-00	1
NSS	Washers, Bolt	90209-08M02-00	4



18-3311
WATER PUMP KIT

With Housing
Replaces: 6G5-W0078-A1-00

— CONTAINS —

Part #	Description	O.E.#	Qty.
18-0244	Gasket, Water Pump	6E5-44315-A0-00	1
18-0256	Bolt	97095-08045-00	4
18-3071	Impeller	6E5-44352-01-00	1
18-3170	Housing, Water Pump	6E5-44311-00-00	1
18-3302	Key, Impeller	90280-04M05-00	1
18-3333	Cup, Insert	61A-44322-00-00	1
18-3345	Plate, Wear	6G5-44323-01-00	1
18-7483	O-Ring (6G8)	93210-37M67-00	1
18-7485	O-Ring	93210-86M38-00	1
NSS	Pin, Dowel	93606-12019-00	2
NSS	Washer, Bolt	90209-08M02-00	4

APPLICATION BEGINS ON PAGE 505

**18-3312
WATER PUMP KIT**

Without Housing
Replaces: 6N6-W0078-00-00

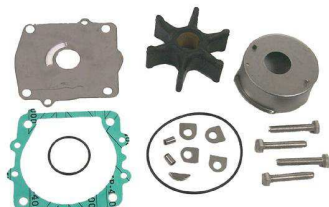

— CONTAINS —

Part #	Description	O.E. #	Qty.
18-0244	Gasket, Water Pump	6E5-44315-A0-00	1
18-0256	Bolt	97095-08045-00	4
18-3071	Impeller	6E5-44352-01-00	1
18-3302	Key, Impeller	90280-04M05-00	1
18-3333	Cup, Insert	61A-44322-00-00	1
18-3344	Plate, Wear	6E5-44323-00-00	1
18-7483	O-Ring (6G8)	93210-37M67-00	1
18-7485	O-Ring	93210-86M38-00	1
NSS	Pin, Dowel	93606-12019-00	2
NSS	Washer, Bolt	90209-08M02-00	4

**18-3313-1
WATER PUMP KIT**

(with Housing)
Replaces: 6N6-W0078-01-00



— CONTAINS —

Part #	Description	O.E. #	Qty.
18-0244	Gasket, Water Pump	6E5-44315-A0-00	1
18-0256	Bolt	97095-08045-00	4
18-3071	Impeller	6E5-44352-01-00	1
18-3173-1	Housing, Water Pump	6E5-44311-00-00	1
18-3302	Key, Impeller	90280-04M05-00	1
18-3333	Cup, Insert	61A-44322-00-00	1
18-3344	Plate, Wear	6E5-44323-00-00	1
18-7483	O-Ring (6G8)	93210-37M67-00	1
18-7485	O-Ring	93210-86M38-00	1
NSS	Pin, Dowel	93606-12019-00	2
NSS	Washer, Bolt	90209-08M02-00	4

**18-3370
WATER PUMP KIT**

Without Housing
Replaces: 692-W0078-00-00,
692-W0078-01-00, 692-W0078-A0-00



— CONTAINS —

Part #	Description	O.E. #	Qty.
18-0239	Gasket, Water Pump	688-44315-A0-00	1
18-0240	Gasket, Water Pump	688-44316-A0-00	1
18-3070	Impeller	688-44352-03-00	1
18-3301	Key, Impeller	90280-04M04-00	1
18-7436	O-Ring	93210-46044-00	1
NSS	Bolt	97395-08050-00	4
NSS	Cup, Insert	688-44322-00-00	1
NSS	Plate, Wear	688-44323-00-00	1
NSS	Gasket, Water Pump	688-44315-A0-00	1
NSS	Gasket, Water Pump	688-44324-A0-00	1

**18-3371
WATER PUMP KIT (with Housing)**

Replaces: 692-W0078-A0-00



— CONTAINS —

Part #	Description	O.E. #	Qty.
18-3070	Impeller	688-44352-03-00	1
18-3171	Housing, Water Pump	688-44311-01-00	1
18-3301	Key, Impeller	90280-04M04-00	1
18-7436	O-Ring	93210-46044-00	1
NSS	Bolt	97395-08070-00	2
NSS	Bolt	97395-08050-00	2
NSS	Cup, Insert	688-44322-00-00	1
NSS	Plate, Wear	688-44323-00-00	1
NSS	Gasket, Water Pump	688-44315-A0-00	1
NSS	Gasket, Water Pump	688-44324-A0-00	1
NSS	Gasket, Water Pump	688-44316-A0-00	1

**18-3372
WATER PUMP KIT**

Without Housing
Replaces: 6E5-W0078-01-00



— CONTAINS —

Part #	Description	O.E. #	Qty.
18-0244	Gasket, Water Pump	6E5-44315-A0-00	1
18-0256	Bolt	97095-08045-00	4
18-3071	Impeller	6E5-44352-01-00	1
18-3302	Key, Impeller	90280-04M05-00	1
18-3344	Plate, Wear	6E5-44323-00-00	1
18-7483	O-Ring	93210-37M67-00	1
18-7485	O-Ring	93210-86M38-00	1
NSS	Pin, Dowel	93606-12019-00	2
NSS	Washer, Bolt	90209-08M02-00	4
NSS	Cup, Insert	6E5-44322-00-00	1

**18-3373
WATER PUMP KIT**

(with Housing)
Replaces: 6E5-W0078-A1-00



— CONTAINS —

Part #	Description	O.E. #	Qty.
18-0244	Gasket, Water Pump	6E5-44315-A0-00	1
18-0256	Bolt	97095-08045-00	4
18-3071	Impeller	6E5-44352-01-00	1
18-3170	Housing, Water Pump	6E5-44311-00-00	1
18-3302	Key, Impeller	90280-04M05-00	1
18-3344	Plate, Wear	6E5-44323-00-00	1
18-7483	O-Ring (6G8)	93210-37M67-00	1
18-7485	O-Ring	93210-86M38-00	1
NSS	Pin, Dowel	93606-12019-00	2
NSS	Washer, Bolt	90209-08M02-00	4
NSS	Cup, Insert	6E5-44322-00-00	1

**18-3395
WATER PUMP KIT**

Without Housing
Replaces: 61A-W0078-01-00



— CONTAINS —

Part #	Description	O.E. #	Qty.
18-0244	Gasket, Water Pump	6E5-44315-A0-00	1
18-0256	Bolt	97095-08045-00	4
18-3071	Impeller	6E5-44352-01-00	1
18-3302	Key, Impeller	90280-04M05-00	1
18-3333	Cup, Insert	61A-44322-00-00	1
18-3345	Plate, Wear	6E5-44323-01-00	1
18-7483	O-Ring (6G8)	93210-37M67-00	1
18-7485	O-Ring	93210-86M38-00	1
NSS	Pin, Dowel	93606-12019-00	2
NSS	Washer, Bolt	90209-08M02-00	4

**18-3396-1
WATER PUMP KIT**

(with Housing)
Replaces: 61A-W0078-A2-00, 61A-W0078-A3-00

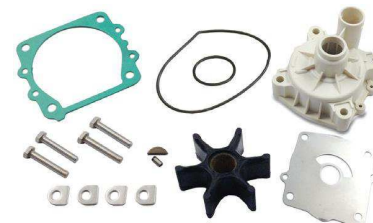

— CONTAINS —

Part #	Description	O.E. #	Qty.
18-0244	Gasket, Water Pump	6E5-44315-A0-00	1
18-0256	Bolt	97095-08045-00	4
18-3071	Impeller	6E5-44352-01-00	1
18-3173-1	Housing, Water Pump	6E5-44311-00-00	1
18-3302	Key, Impeller	90280-04M05-00	1
18-3333	Cup, Insert	61A-44322-00-00	1
18-3345	Plate, Wear	6E5-44323-01-00	1
18-7483	O-Ring (6G8)	93210-37M67-00	1
18-7485	O-Ring	93210-86M38-00	1
NSS	Pin, Dowel	93606-12019-00	2
NSS	Washer, Bolt	90209-08M02-00	4

**18-3397
WATER PUMP KIT**

Without Housing

Replaces: 679-W0078-00-00, 679-W0078-A0-00

— CONTAINS —



Part #	Description	O.E. #	Qty.
18-3088	Impeller	6F5-44352-00-00	1
18-0256	Bolt	97095-08045-00	2
18-3300	Key, Impeller	90280-04M00-00	1
18-3334	Cup, Insert	676-44322-00-00	1
NSS	Gasket, Water Pump	676-44315-A0-00	1
NSS	Gasket, Water Pump	676-44324-A0-00	1
NSS	Gasket, Water Pump	679-44316-A0-00	1
NSS	Plate, Wear	676-44323-00-00	1
NSS	Bolt	97095-08055-00	2
NSS	Seal, Water	663-44366-00-00	1
NSS	Washer, Bolt	92990-08600-00	4

**18-3398
WATER PUMP KIT
(with Housing)**

Replaces: 6F5-W0078-A0-00, 6F5-W0078-00-00

— CONTAINS —



Part #	Description	O.E. #	Qty.
18-3088	Impeller	6F5-44352-00-00	1
18-0237	Gasket, Water Pump Outer	676-44315-A0-00	1
18-0256	Bolt	97095-08045-00	2
18-3300	Key, Impeller	90280-04M00-00	1
18-3334	Cup, Insert	676-44322-00-00	1
NSS	Gasket, Water Pump	676-44324-A0-00	1
NSS	Gasket, Water Pump	679-44316-A0-00	1
NSS	Plate, Wear	676-44323-00-00	1
NSS	Housing, Water Pump	676-44311-00-00	1
NSS	Bolt	97095-08055-00	2
NSS	Seal, Water	663-44366-00-00	1
NSS	Washer, Bolt	92990-08600-00	4

**18-3428-1
WATER PUMP KIT**

Without Housing

Replaces: 6H3-W0078-00-00, 6H3-W0078-A0-00

— CONTAINS —

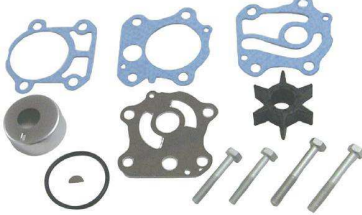

Part #	Description	O.E. #	Qty.
18-0240	Gasket, Water Pump	688-44316-A0-00	1
18-0256	Bolt	97095-08045-00	2
18-0756-1	Gasket, Water Pump	6H3-44315-A0-00	1
18-0757	Gasket, Outer Plate	6H3-44324-A0-00	1
18-3069	Impeller	697-44352-00-00	1
18-3297	Key, Impeller	90280-03M03-00	1
18-3435	Cup, Impeller	663-44322-00-00	1
18-7436	O-Ring	93210-46044-00	1
NSS	Bolt	97095-08055-00	2
NSS	Plate, Wear	63D-44323-00-00	1

**18-3461
WATER PUMP KIT
(with Housing)**

Replaces: 6H3-W0078-00-00, A0-00,

6H3-44311-00-00

For: 70(1984-91), P60(1991), T50(1996)

— CONTAINS —



Part #	Description	O.E. #	Qty.
NSS	Housing, Water Pump	6H3-44311-00-00	1
18-0240	Gasket, Water Pump	688-44316-A0-00	1
18-0256	Bolt	97095-08045-00	2
18-0756-1	Gasket, Water Pump	6H3-44315-A0-00	1
18-0757	Gasket, Outer Plate	6H3-44324-A0-00	1
18-3069	Impeller	697-44352-00-00	1
18-3297	Key, Impeller	90280-03M03-00	1
18-3435	Cup, Impeller	663-44322-00-00	1
18-7436	O-Ring	93210-46044-00	1
NSS	Bolt	97395-08055-00	2
NSS	Plate, Wear	6H3-44323-00-00	1

**18-3429
WATER PUMP KIT**

Without Housing

Replaces: 6H4-W0078-00-00, 6H4-W0078-A0-00

— CONTAINS —



Part #	Description	O.E. #	Qty.
18-0256	Bolt	97095-08045-00	2
18-0258	Bolt	97095-08055-00	2
18-0292	Gasket, Wear Plate to Housing	663-44315-A0-00	1
18-0294	Gasket, Wear Plate to Base	663-44324-A0-00	1
18-3068	Impeller	6H4-44352-00-00	1
18-3297	Key, Impeller	90280-03M03-00	1
18-3435	Cup, Insert	663-44322-00-00	1
18-3436	Plate, Wear	663-44323-00-00	1
NSS	Gasket, Water Pump	663-44316-A0-00	1
NSS	Seal	93101-23070-00	1

**18-3408
WATER PUMP KIT With Housing**

Replaces: 6H4-W0078-00, A0, 663-44311-02

For: 40(1984-87), 50(1984-87), Pro50(1987)

— CONTAINS —



Part #	Description	O.E. #	Qty.
NSS	Housing, Water Pump	6J8-44311-00-00	1
18-0256	Bolt	97095-08045-00	2
18-0258	Bolt	97395-08055-00	2
18-0292	Gasket, Wear Plate to Housing	663-44315-A0-00	1
18-0294	Gasket, Wear Plate to Base	663-44324-A0-00	1
18-3068	Impeller	6H4-44352-00-00	1
18-3297	Key, Impeller	90280-03M03-00	1
18-3435	Cup, Insert	663-44322-00-00	1
18-3436	Plate, Wear	663-44323-00-00	1
NSS	Gasket, Water Pump	663-44316-00-00	1
NSS	Seal	93101-23070-00	1

**18-3433
WATER PUMP KIT**

Without Housing

Replaces: 63V-W0078-01-00

Fits: 9.9/15(1996-04), F15 (1998-04)

— CONTAINS —



Part #	Description	O.E. #	Qty.
18-0256	Bolt	97095-08045-00	4
18-3040	Impeller	63V-44352-01-00	1
18-3195	Plate, Wear	63V-44323-00-00	1
18-3294	Key, Impeller	63V-44338-00-00	1
18-3444	Cup, Insert	63V-44322-00-00	1
NSS	Seal, Water	647-44366-00-00	1

**18-3412
WATER PUMP KIT
(with Housing)**

Replaces: 63V-W0078-01, 63V-44301-00

For: 9.9(1996-09), 15(1996-09), F9.9(2005-06), F15(1998-05), T9.9(2005-06)

— CONTAINS —



Part #	Description	O.E. #	Qty.
18-0256	Bolt	97095-08045-00	4
18-3040	Impeller	63V-44352-01-00	1
18-3195	Plate, Wear	63V-44323-00-00	1
18-3294	Key, Impeller	63V-44338-00-00	1
18-3356	Housing, Water Pump	63V-44301-00-00	1
18-3444	Cup, Insert	63V-44322-00-00	1
NSS	Seal, Water	647-44366-00-00	1

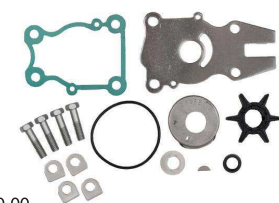

**18-3434
WATER PUMP KIT**
Without Housing
Replaces: 63D-W0078-01-00, 63D-44311-00-00
Fits: 40/50(1995-03), P40(1998), C40 3 cyl(1997-02), C50(1999-01), F40 2.6L(1999), F50(1995-03), P50 (1995-96), F60(2002-03)
For kit with housing, order **18-3415** — CONTAINS —

Part #	Desc.	O.E.#	Qty.
18-0483	Gasket, Pump Case	63D-44316-00-00	1
18-3069	Impeller	697-44352-00-00	1
18-3186	Plate, Wear	63D-44323-00-00	1
18-3297	Key, Impeller	90280-03M03-00	1
18-3449	Cup, Insert	63D-44322-00-00	1
18-8400-9	Bolt (Set of 4)	90119-08M15-00	1
NSS	Cover, Pump Housing	63D-44312-00-00	1
NSS	Washer, Bolt	90209-08M02-00	4
NSS	O-Ring	93210-59MG7-00	1
NSS	Seal, Water	663-44366-00-00	1



**18-3415
WATER PUMP KIT (with Housing)**
Replaces: 63D-W0078-01-00, 63D-44311-00-00
Fits: 40/50(1995-03), P40(1998), C40 3 cyl(1997-02), C50(1999-01), F40 2.6L(1999), F50(1995-03), P50 (1995-96), F60(2002-03)
For kit w/o housing, order **18-3434** — CONTAINS —

Part #	Desc.	O.E.#	Qty.
18-0483	Gasket, Water Pump Case	63D-44316-00-00	1
18-3069	Impeller	697-44352-00-00	1
18-3186	Plate, Wear	63D-44323-00-00	1
18-3297	Key, Impeller	90280-03M03-00	1
18-3449	Cup, Insert	63D-44322-00-00	1
18-8400-9	Bolt (Set of 4)	90119-08M15-00	1
NSS	Cover, Water Pump Housing	63D-44312-00-00	1
NSS	Washer, Bolt	90209-08M02-00	4
NSS	O-Ring	93210-59MG7-00	1
NSS	Seal, Water	663-44366-00-00	1
NSS	Housing, Water Pump	63D-44311-00-00	1

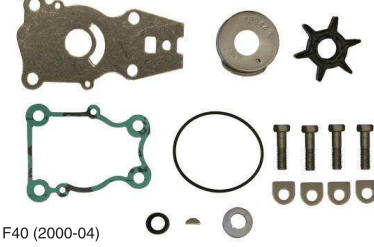

**18-3440
WATER PUMP KIT**
Without Housing
Replaces: 66T-W0078-00-00
Fits: T25 (2001-04), F30 (2001-04), F40 (2000-04)

Part #	Desc.	O.E.#	Qty.
18-0483	Gasket, Pump Case	63D-44316-00-00	1
18-3068	Impeller	6H4-44352-00-00	1
18-3196	Plate, Impeller	66T-44323-00-00	1
18-3297	Key, Impeller	90280-03M03-00	1
18-3449	Cup, Insert	63D-44322-00-00	1
18-8400-9	Bolt (Set of 4)	90119-08M15-00	1
NSS	Cover, Pump Housing	63D-44312-00-00	1
NSS	O-Ring	93210-59MG7-00	1
NSS	Seal, Water	663-44366-00-00	1
NSS	Washer	90209-08M02-00	4



**18-3413
WATER PUMP KIT (with Housing)**
Replaces: 66T-W0078-00, 66T-44311-00
For: F30(2001-05), F40(2000-08), T25 (2001-06)
For kit w/o housing, order **18-3440** — CONTAINS —

Part #	Desc.	O.E.#	Qty.
18-0483	Gasket, Water Pump Case	63D-44316-00-00	1
18-3068	Impeller	6H4-44352-00-00	1
18-3196	Plate, Wear	66T-44323-00-00	1
18-3297	Key, Impeller	90280-03M03-00	1
18-3449	Cup, Insert	63D-44322-00-00	1
18-8400-9	Bolt (Set of 4)	90119-08M15-00	1
NSS	Cover, Water Pump Housing	63D-44312-00-00	1
NSS	O-Ring	93210-59MG7-00	1
NSS	Seal, Water	663-44366-00-00	1
NSS	Washer, Bolt	90209-08M02-00	4
NSS	Housing, Water Pump	66T-44311-00-00	1

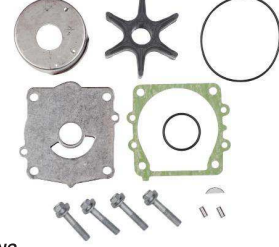

**18-3442
WATER PUMP REPAIR KIT**
Without Housing
Replaces: 68V-W0078-00-00
For: F115 2002-2010 / LF115 2002-2010

Part #	Desc.	O.E.#	Qty.
18-0244	Gasket, Water Pump	6E5-44315-A0-00	2
18-0256	Bolt	97095-08045-00	4
18-3071	Impeller	6E5-44352-01-00	1
18-3302	Key, Impeller	90280-04M05-00	1
18-3519	Cup, Insert	61A-44322-02-00	1
18-3521	Plate, Wear	68V-44323-00-00	1
18-7483	O-Ring (6G8)	93210-37M67-00	1
18-7485	O-Ring	93210-86M38-00	1
NSS	Pin, Dowel	93606-12019-00	2
NSS	Washer	90209-08M02-00	4



**18-3523-1
WATER PUMP KIT (with Housing)**
Replaces: 68V-W0078-00, 61A-44311-01
Fits: F115 & LF115 (2002 & Up)

Part #	Desc.	O.E.#	Qty.
18-0244	Gasket, Water Pump	6E5-44315-A0-00	2
18-0256	Bolt	97095-08045-00	4
18-3071	Impeller	6E5-44352-01-00	1
18-3173-1	Housing, Water Pump	61A-44311-01-00	1
18-3302	Key, Impeller	90280-04M05-00	1
18-3519	Cup, Insert	61A-44322-02-00	1
18-3521	Plate, Wear	68V-44323-00-00	1
18-7483	O-Ring (6G8)	93210-37M67-00	1
18-7485	O-Ring	93210-86M38-00	1
NSS	Pin, Dowel	93606-12019-00	2
NSS	Washer, Bolt	90209-08M02-00	4

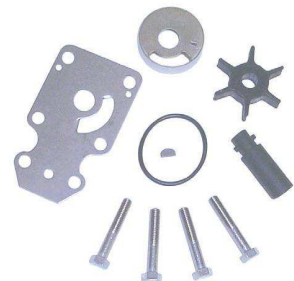

**18-3450
WATER PUMP KIT**
Without Housing
Replaces: 68T-W0078-00-00
For: F6, F8 (2001-05)

Part #	Desc.	O.E.#	Qty.
18-0256	Bolt	97095-08045-00	4
18-3142	Plate, Wear	68T-44323-00-00	1
18-3176	Seal, Water Damper	68T-44366-00-00	1
18-3294	Key, Impeller	63V-44338-00-00	1
18-3444	Cup, Insert	63V-44322-00-00	1
18-8910	Impeller	68T-44352-00-00	1
NSS	O-Ring	93210-44398-00	1



**18-3410
WATER PUMP KIT (with Housing)**
Replaces: 68T-W0078-00, 63V-44301-00
For: F6(01-08), F8(01-09), F9.9(07-09)

Part #	Desc.	O.E.#	Qty.
18-0256	Bolt	97095-08045-00	4
18-3142	Plate, Wear	68T-44323-00-00	1
18-3176	Seal, Water Damper	68T-44366-00-00	1
18-3294	Key, Impeller	63V-44338-00-00	1
18-3356	Housing, Water Pump	63V-44301-00-00	1
18-3444	Cup, Insert	63V-44322-00-00	1
18-8910	Impeller	68T-44352-00-00	1
NSS	O-Ring	93210-44398-00	1

**18-3451
WATER PUMP KIT**

Replaces: 67F-W0078-00-00
Fits: F75 (2003-06), F80(1999-03), F90(2003-04), F100(1999-02)

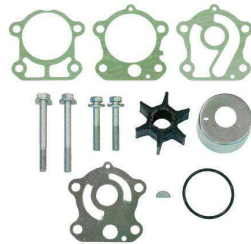

— CONTAINS —

Part #	Desc.	O.E.#	Qty.
18-2605	Bolt	90119-08M87-00	2
18-2606	Bolt	90119-08M13-00	2
18-3042	Impeller	67F-44352-00-00	1
18-3143	Plate, Wear	67F-44323-00-00	1
18-3162	Cup, Insert	67F-44322-00-00	1
18-3301	Key, Impeller	90280-04M04-00	1
18-7436	O-Ring	93210-46044-00	1
NSS	Gasket, Water Pump	688-44315-A0-00	1
NSS	Gasket, Water Pump	688-44324-A0-00	1
NSS	Gasket, Water Pump	688-44316-A0-00	1
NSS	Washer, Bolt	90209-08M02-00	4

**18-3409
WATER PUMP KIT (with Housing)**

Replaces: 67F-W0078-00, 67F-44311-01
For: F75(2006-10), F80(1999-03), F90(2006-10), F100(1999-03)



— CONTAINS —

Part #	Desc.	O.E.#	Qty.
18-2605	Bolt	90119-08M87-00	2
18-2606	Bolt	90119-08M13-00	2
18-3042	Impeller	67F-44352-00-00	1
18-3143	Plate, Wear	67F-44323-00-00	1
18-3162	Cup, Insert	67F-44322-00-00	1
18-3301	Key, Impeller	90280-04M04-00	1
18-7436	O-Ring	93210-46044-00	1
NSS	Gasket, Water Pump	688-44315-A0-00	1
NSS	Gasket, Water Pump	688-44324-A0-00	1
NSS	Gasket, Water Pump	688-44316-A0-00	1
NSS	Housing, Water Pump	67F-44311-01-00	1
NSS	Washer, Bolt	90209-08M02-00	4

**18-3465
WATER PUMP KIT**

Without Housing

Replaces: 6H3-W0078-02-00
Fits: T50(1997-05), 60(2001-03), C60(1997-01), C70(2000-01), P60(1997-99), T60(2003-05), 70(1997-03)

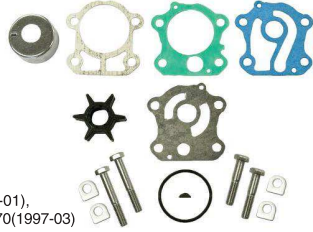

— CONTAINS —

Part #	Desc.	O.E.#	Qty.
18-3069	Impeller	697-44352-00-00	1
18-0256	Bolt	97095-08045-00	2
18-0757	Gasket, Water Pump	6H3-44324-A0-00	1
18-3297	Key, Impeller	90280-03M03-00	1
18-3435	Cup, Insert	663-44322-00-00	1
18-7436	O-Ring	93210-46044-00	1
NSS	Plate, Wear	6H3-44323-00-00	1
NSS	Gasket, Water Pump	6H3-44315-A0-00	1
NSS	Gasket, Water Pump	6H3-44324-A0-00	1
NSS	Bolt	97095-08055-00	2
NSS	Washer, Bolt	90209-08M02-00	4

**18-3466
WATER PUMP KIT (with Housing)**

Replaces: 6H3-W0078-01, 6H3-44311-00
For: 70(1992-03), C60(1996-01), E60(1995-96), P60(1992-99), C70(2000-01), T50(1997-10), T60(2003-10)



— CONTAINS —

Part #	Desc.	O.E.#	Qty.
NSS	Housing, Water Pump	6H3-44311-00-00	1
18-0256	Bolt	97095-08045-00	2
18-0757	Gasket, Water Pump	6H3-44324-A0-00	1
18-3069	Impeller	697-44352-00-00	1
18-3297	Key, Impeller	90280-03M03-00	1
18-3435	Cup, Insert	663-44322-00-00	1
18-7436	O-Ring	93210-46044-00	1
NSS	Plate, Wear	6H3-44323-00-00	1
NSS	Gasket, Water Pump	6H3-44315-A0-00	1
NSS	Gasket, Water Pump	688-44316-A0-00	1
NSS	Bolt	97095-08055-00	2
NSS	Washer, Bolt	90209-08M02-00	4

**18-3470
WATER PUMP REPAIR KIT**

Without Housing

Replaces: 6CE-W0078-01
Fits: F225 (2010-15), F250 (2010), F250 (2010-15), F300 (2007-15), F350 (2007-15), FL250 (2010), FL300 (2010), FL350 (2010), LF225 (2010-15), LF250 (2010-15), LF300 (2007-15), LF350 (2007-15), VF250 (2015)



— CONTAINS —

Part #	Desc.	O.E.#	Qty.
18-7471	O-Ring, Outer	93210-94003-00	1
18-0256	Bolt	97095-08045-00	4
18-2091	Seal, Oil	93104-22M07-00	2
18-3302	Key, Impeller	90280-04M05-00	1
18-3457	Cup, Insert	6AW-44322-00-00	1
18-3458	Gasket, Water Pump	6CE-44315-00-00	1
18-3459	Plate, Wear	6CE-44323-01-00	1
18-45617-1	Impeller	6CE-44352-00-00	1
18-7483	O-Ring (6G8)	93210-37M67-00	1
NSS	Washer, Bolt	90209-08M02-00	4
NSS	Pin, Dowell	93606-12019-00	2

**18-3471
WATER PUMP REPAIR KIT**

(with Housing)

Replaces: 6CE-W0078-01 + 6CE-44311-01
Fits: F225 (2010-15), F250 (2010), F250 (2010-15), F300 (2007-15), F350 (2007-15), FL250 (2010), FL300 (2010), FL350 (2010), LF225 (2010-15), LF250 (2010-15), LF300 (2007-15), LF350 (2007-15), VF250 (2015)



— CONTAINS —

Part #	Desc.	O.E.#	Qty.
18-7471	O-Ring, Outer	93210-94003-00	1
18-0256	Bolt	97095-08045-00	4
18-2091	Seal, Oil	93104-22M07-00	2
18-3302	Key, Impeller	90280-04M05-00	1
18-3457	Cup, Insert	6AW-44322-00-00	1
18-3458	Gasket, Water Pump	6CE-44315-00-00	1
18-3459	Plate, Wear	6CE-44323-01-00	1
18-3482	Housing, Water Pump	6CE-44311-01-00	1
18-45617-1	Impeller	6CE-44352-00-00	1
18-7483	O-Ring (6G8)	93210-37M67-00	1
NSS	Washer, Bolt	90209-08M02-00	4
NSS	Pin, Dowell	93606-12019-00	2

**18-3516
WATER PUMP REPAIR KIT**

Without Housing

Replaces: 60X-W0078-00-00
For: VZ200 (3.3L) 2005-2010, VZ225 (3.3L) 2003-2010, VZ250 (3.3L) 2003-2010, VZ300 (3.3L) 2005-2010

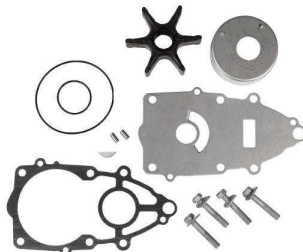

— CONTAINS —

Part #	Desc.	O.E.#	Qty.
18-0256	Bolt	97095-08045-00	4
18-3071	Impeller	6E5-44352-01-00	1
18-3302	Key, Impeller	90280-04M05-00	1
18-3519	Cup, Insert	61A-44322-02-00	1
18-3520	Plate, Wear	60X-44323-00-00	1
18-7483	O-Ring (6G8)	93210-37M67-00	1
18-7485	O-Ring	93210-86M38-00	1
18-0406	Gasket, Water Pump	60X-44315-A0-00	1
NSS	Pin, Dowell	93606-12019-00	2
NSS	Washer, Bolt	90209-08M02-00	4

**18-3522-1
WATER PUMP KIT**

(with Housing)

Replaces: 60X-W0078-00, 61A-44311-01
For: VZ200(2005-09), VZ225(2003-09), VZ250(2003-09), VZ300(2004-09)

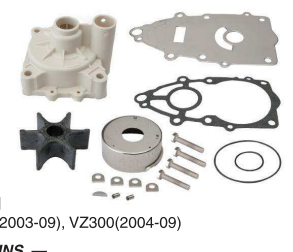

— CONTAINS —

Part #	Desc.	O.E.#	Qty.
18-0256	Bolt	97095-08045-00	4
18-3071	Impeller	6E5-44352-01-00	1
18-3173-1	Housing, Water Pump	6E5-44311-00-00	1
18-3302	Key, Impeller	90280-04M05-00	1
18-3519	Cup, Insert	61A-44322-02-00	1
18-3520	Plate, Wear	60X-44323-00-00	1
18-7483	O-Ring (6G8)	93210-37M67-00	1
18-7485	O-Ring, Outer	93210-86M38-00	1
NSS	Gasket, Water Pump	60X-44315-A0-00	1
NSS	Pin, Dowell	93606-12019-00	2
NSS	Washer, Bolt	90209-08M02-00	4

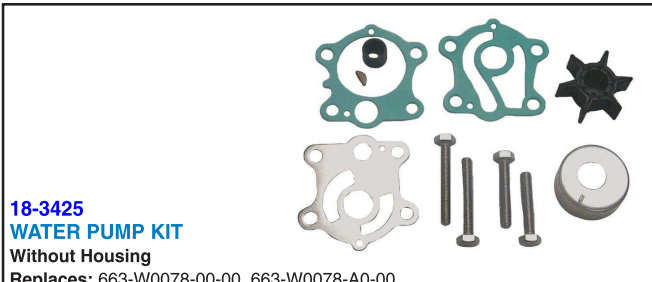

18-3425
WATER PUMP KIT

Without Housing

Replaces: 663-W0078-00-00, 663-W0078-A0-00

— CONTAINS —

Part #	Description	O.E.#	Qty.
18-0256	Bolt	97095-08045-00	2
18-0292	Gasket, Water Pump	663-44315-00-00	1
18-0294	Gasket, Water Pump	663-44324-A0-00	1
18-3069	Impeller	697-44352-00-00	1
18-3297	Key, Impeller	90280-03M03-00	1
18-3435	Cup, Insert	663-44322-00-00	1
18-3436	Plate, Wear	663-44323-00-00	1
NSS	Bolt	97095-08055-00	2
NSS	Seal, Water	663-44366-00-00	1

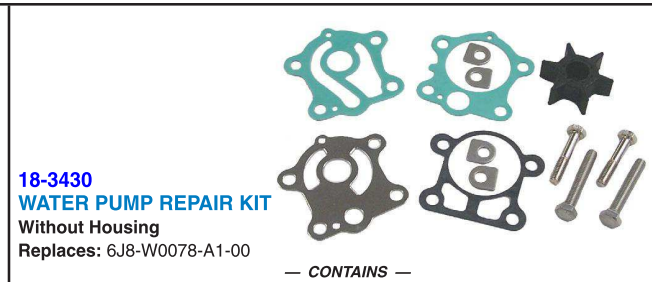

18-3430
WATER PUMP REPAIR KIT

Without Housing

Replaces: 6J8-W0078-A1-00

— CONTAINS —

Part #	Description	O.E.#	Qty.
18-0294	Gasket, Water Pump	663-44324-A0-00	1
18-3068	Impeller	6H4-44352-00-00	1
18-3435	Cup, Insert	663-44322-00-00	1
18-3436	Plate, Wear	663-44323-00-00	1
NSS	Gasket, Water Pump	663-44315-A0-00	1
NSS	Gasket, Water Pump	663-44324-A0-00	1
NSS	Bolt	97395-08050-00	2
NSS	Bolt	97395-08040-00	2
NSS	Washer, Bolt	90209-08M02-00	4



18-3431
WATER PUMP KIT

Without Housing

Replaces: 6L2-W0078-00-00

— CONTAINS —

Part #	Description	O.E.#	Qty.
NSS	Cup, Insert	6L2-44322-00-00	1
18-2607	Bolt	97095-06040-00	4
18-3065	Impeller	6L2-44352-00-00	1
18-7483	O-Ring (6G8)	93210-37M67-00	1
NSS	Plate, Wear	6L2-44323-00-00	1

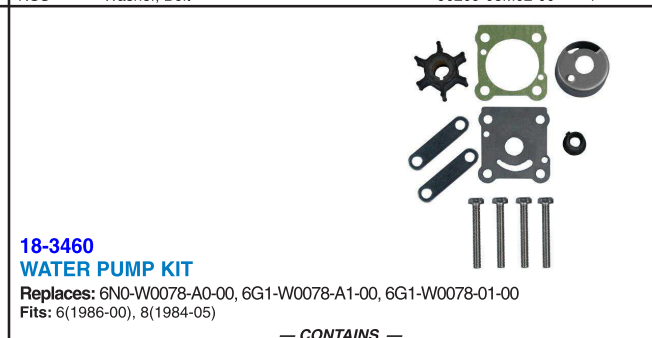

18-3460
WATER PUMP KIT

Replaces: 6N0-W0078-A0-00, 6G1-W0078-A1-00, 6G1-W0078-01-00

Fits: 6(1986-00), 8(1984-05)

— CONTAINS —

Part #	Desc.	O.E.#	Qty.
18-0753	Gasket, Water Pump	6G1-44315-A0-00	1
18-3066	Impeller	6G1-44352-00-00	1
18-3456	Cup, Insert	6G1-44322-00-00	1
NSS	Plate, Wear	6G1-44323-00-00	1
NSS	Plate, Bolt	6G1-44328-00-00	2
NSS	Bolt	97095-06045-00	4
NSS	Seal, Water	647-44366-00-00	1



18-3462
WATER PUMP KIT

Replaces: 6A1-W0078-02-00

Fits: 2(1988-02)

— CONTAINS —

Part #	Desc.	O.E.#	Qty.
18-1079	Protector, Oil Seal	6A1-44325-00-00	1
18-3072	Impeller	646-44352-01-00	1
18-3328	Cup, Insert	646-44322-00-00	1
18-3357	Plate, Wear	646-44323-00-00	1
18-7463	O-Ring	93210-19123-00	1
NSS	Seal, Water	646-44366-01-00	1
NSS	Seal, Oil	93101-11M44-00	2
NSS	Pin, Dowel	93604-09068-00	2
NSS	Bolt	97095-05016-00	2



18-3463
WATER PUMP KIT

Replaces: 6A1-W0078-01-00

Fits: 2(1984-87)

— CONTAINS —

Part #	Desc.	O.E.#	Qty.
18-1079	Protector, Oil Seal	6A1-44325-00-00	1
18-3328	Impeller	646-44322-00-00	1
18-3328	Cup, Insert	646-44322-00-00	1
18-3357	Plate, Wear	646-44323-00-00	1
18-7463	O-Ring	93210-19123-00	1
NSS	Seal, Water	646-44366-01-00	1
NSS	Seal, Oil	93103-11051-00	1
NSS	Pin, Dowel	93604-09068-00	2
NSS	Bolt	97095-05016-00	2

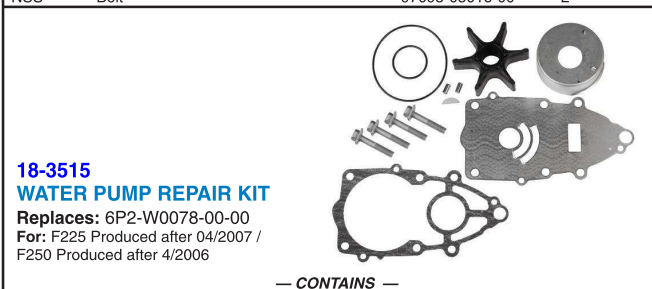

18-3515
WATER PUMP REPAIR KIT

Replaces: 6P2-W0078-00-00

For: F225 Produced after 04/2007 / F250 Produced after 4/2006

— CONTAINS —

Part #	Desc.	O.E.#	Qty.
18-0256	Bolt	97095-08045-00	4
18-0406	Gasket, Water Pump	60X-44315-A0-00	1
18-3071	Impeller	6E5-44352-01-00	1
18-3302	Key, Impeller	90280-04M05-00	1
18-3518	Plate, Wear	6P2-44323-00-00	1
18-3519	Cup, Insert	61A-44322-02-00	1
18-7483	O-Ring (6G8)	93210-37M67-00	1
18-7485	O-Ring	93210-86M38-00	1
NSS	Pin, Dowel	93606-12019-00	2
NSS	Washer, Bolt	90209-08M02-00	4

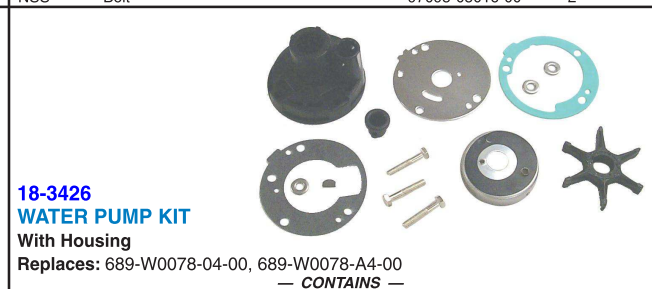

18-3426
WATER PUMP KIT

With Housing

Replaces: 689-W0078-04-00, 689-W0078-A4-00

— CONTAINS —

Part #	Description	O.E.#	Qty.
18-3067	Impeller	689-44352-02-00	1
18-3294	Key, Impeller	63V-44338-00-00	1
NSS	Housing, Water Pump	689-44311-03-00	1
NSS	Gasket, Water Pump	689-44324-A0-00	1
NSS	Cup, Insert	689-W4432-02-00	1
NSS	Plate, Wear	689-44323-03-00	1
NSS	Washer, Bolt	90209-06M04-00	3
NSS	Bolt	90101-06M56-00	3
NSS	Grommet	689-44366-00-00	1
NSS	Gasket, Seal Cover	689-44315-01-00	1

18-3432
WATER PUMP KIT

Replaces: 61N-W0078-11-00
Fits: F25(1998-05)



— CONTAINS —

Part #	Desc.	O.E.#	Qty.
18-0191	Plate, Washer	92990-06600-00	4
18-2607	Bolt	97095-06040-00	4
18-3068	Impeller	6H4-44352-00-00	1
18-3185	Housing, Water Pump	61N-44311-01-00	1
18-3194	Plate, Wear	61N-44323-00-00	1
18-3297	Key, Impeller	90280-03M03-00	1
18-3443	Cup, Insert	61N-44322-01-00	1
18-7115	O-Ring	93210-45161-00	1
NSS	Seal, Water	6L2-44367-00-00	1

18-3427
WATER PUMP KIT

With Housing
Replaces: 689-W0078-A6-00

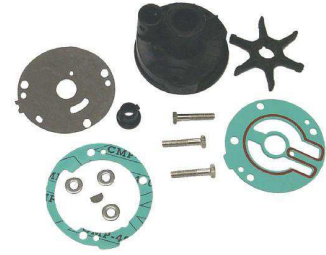

— CONTAINS —

Part #	Description	O.E.#	Qty.
18-3067	Impeller	689-44352-02-00	1
18-3294	Key, Impeller	63V-44338-00-00	1
NSS	Gasket, Water Pump	689-44316-A0-00	1
NSS	Plate, Wear	689-44323-03-00	1
NSS	Gasket, Water Pump	689-44324-A0-00	1
NSS	Cup, Insert	689-44352-02-00	1
NSS	Housing, Water Pump	689-44311-03-00	1
NSS	Washer, Bolt	90209-06M04-00	3
NSS	Bolt	90101-06M56-00	3
NSS	Grommet	689-44368-00-00	1

18-48619
COMPLETE WATER PUMP KIT

Replaces: 68D-WG078-00-00
Fits: Yamaha F4(2002-08)



— CONTAINS —

Part #	Desc.	O.E.#	Qty.
18-43263	Housing, Water Pump	68D-G4311-01-00	1
18-3073	Impeller	6E0-44352-00-00	1
18-43531	Cup, Insert	6E0-44322-02-00	1
18-43716	Pin, Impeller	93604-18080-00	1
18-43818	Bolt	97095-06045-00	4
18-60541	Gasket, Water Pump	6BX-G4315-01-00	1
NSS	Plate, Wear	6E0-44323-00-00	1
NSS	Tube, Rubber	67D-44366-00-00	1
NSS	Washer, Bolt	N/A	4
NSS	Plate, Bolt	68D-G4328-00-00	2

NEW

18-3473
WATER PUMP KIT

With Housing
Replaces: 6EE-W0078-00-00
Fits: F4 (2009-17), F6 (2009-17)



— CONTAINS —

Part #	Description	O.E.#	Qty.
18-3073	Impeller	6E0-44352-00	1
18-4567	Housing, Water Pump	6EE-G4311-00	1
18-60541	Gasket, Water Pump	6EE-G4315-00	1
18-4546	Cup, Insert	6EE-G4322-00	1
18-4573	Plate, Wear	6EE-G4323-00	1
18-1840	Damper, Water Seal 2	6EE-G4366-00	1
18-43716	Pin, Dowel (647)	93604-18080	2
18-0261	Bolt	97080-06045	4

NEW

18-3474
WATER PUMP KIT

Without Housing
Replaces: 6CB-W0078-00-00
Fits: VF225, VF250 (2009-18)



— CONTAINS —

Part #	Description	O.E.#	Qty.
18-3519	Cup, Insert	61A-44322-02	1
18-0451	Gasket, Water Pump	6CV-44315-00	1
18-4572	Plate, Wear	6CV-44323-00	1
18-3071	Impeller	6E5-44352-01	1
NSS	Bolt, With Washer	90119-08M14	4
18-3302	Key, Woodruff	90280-04002	1
18-7483	O-Ring (6G8)	93210-37M67	1
18-7485	O-Ring (6E5)	93210-86M38	1
NSS	Pin, Dowel (614)	93606-12019	2

NEW

18-3475
WATER PUMP KIT

Without Housing
Replaces: 69G-W0078-00
Fits: T9.9 (2007-17)



— CONTAINS —

Part #	Description	O.E.#	Qty.
18-3444	Cup, Insert	63V-44322-00	1
18-3040	Impeller	63V-44352-01	1
18-3294	Key, Woodruff	664-44338-00	1
18-3142	Plate, Wear	68T-44323-00	1
18-3176	Damper, Water Seal 2	68T-44366-00	1
18-71331	O-Ring (55X)	93210-44704	1
18-0256	Bolt	97095-08045	4

NEW

18-3477
WATER PUMP KIT

Without Housing
Replaces: 6AW-W0078-00-00
Fits: F300, LF300 (2007-09)



— CONTAINS —

Part #	Description	O.E.#	Qty.
18-0452	Gasket, Water Pump	6AW-44315-00	1
18-3457	Cup, Insert	6AW-44322-00	1
18-0421	Plate, Wear	6AW-44323-00	1
18-3028	Key, Impeller	6AW-44336-00	1
18-8925	Impeller	6AW-44352-00	1
NSS	Bolt, With Washer	90119-08M14	4
18-7483	O-Ring (6G8)	93210-37M67	1
18-7471	O-Ring (6G8)	93210-94003	1
NSS	Pin, Dowel (614)	93606-12019	2

NEW

18-3479
WATER PUMP KIT

With Housing
Replaces: 6AH-W0078-00
Fits: F15C, F20 (2006-17)

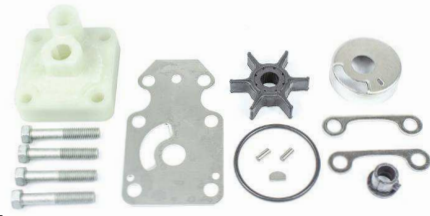

— CONTAINS —

Part #	Description	O.E.#	Qty.
18-3444	Cup, Insert	63V-44322-00	1
18-9090	Plate	63V-44328-01	2
18-3040	Impeller	63V-44352-01	1
18-3294	Key, Woodruff	664-44338-00	1
18-3142	Plate, Wear	68T-44323-00	1
NSS	Housing, Water Pump	6AH-44311-00	1
18-1836	Damper, Water Seal	6L2-44367-00	1
18-71333	O-Ring (620)	93210-49046	1
18-43717	Pin, Dowel (688)	93604-10M03	2
18-0256	Bolt, Hexagon	97095-08045	4

APPLICATION BEGINS ON NEXT PAGE



18-3490
WATER PUMP KIT
Without Housing
Replaces: 6BG-W0078-00-00
Fits: F30 (2013-17), F40A (2008-17)

— CONTAINS —

Part #	Description	O.E. #	Qty.
18-9083	Cover, Water Pump Housing	63D-44312-00	1
18-0483	Gasket, Water Pump	63D-44316-00	1
18-3449	Cup, Insert	63D-44322-00	1
18-3186	Plate, Wear	63D-44323-00	1
18-1828	Seal, Water Damper 2	663-44366-00	1
18-3068	Impeller	6H4-44352-02	1
18-8400-9	Bolt, With Washer	90119-08M15	4
18-3297	Key, Woodruff	90280-03M03	1
18-71334	O-Ring	93210-59MG7	1

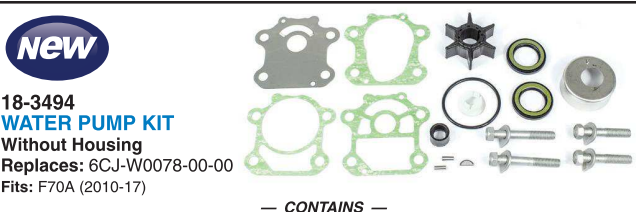

18-3494
WATER PUMP KIT
Without Housing
Replaces: 6CJ-W0078-00-00
Fits: F70A (2010-17)

— CONTAINS —

Part #	Description	O.E. #	Qty.
18-9083	Cover, Water pump Housing	63D-44312-00	1
18-3449	Cup, Insert	63D-44322-00	1
18-1830	Seal, Water Damper 2	663-44366-00	1
18-0448	Gasket, Water Pump	6CJ-44315-00	1
18-0449	Gasket, Water Pump	6CJ-44316-00	1
18-3186	Plate, Wear	6CJ-44323-00	1
18-0450	Gasket, Water Pump	6CJ-44324-00	1
18-3069	Impeller	6H3-44352-00	1
NSS	Bolt, With Washer	90119-08M14	2
18-0260	Bolt, With Washer	90119-08M33	2
18-3297	Key, Woodruff (697)	90280-03M03	1
18-0297	Oil Seal (663)	93101-23070	2
18-7436	O-Ring	93210-46044	1
18-43717	Pin, Dowel (688)	93604-10M03	2



18-4527
WATER PUMP KIT
With Housing
Replaces: 6FM-W0078-00-00
Fits: F25C (2016-17)

— CONTAINS —

Part #	Description	O.E. #	Qty.
18-4576	Plate, Wear	6FM-44323-01	1
18-3486	Housing, Water Pump	6L2-44311-01	1
18-4548	Cup, Insert	6L2-44322-00	1
18-9092	Plate	6L2-44328-00	2
18-3065	Impeller	6L2-44352-00	1
18-1837	Seal, Water Damper 3	6L2-44367-10	1
18-3305	Key, Woodruff (662)	90280-03024	1
18-71332	O-Ring	93210-45161	1
18-43717	Pin, Dowel (688)	93604-10M03	2
18-8407	Bolt, With Washer	97595-06540	4



18-4532
WATER PUMP KIT
Without Housing
Replaces: 6EG-W0078-00-00
Fits: F2.5 (2015-17)

— CONTAINS —

Part #	Description	O.E. #	Qty.
18-1840	Seal, Water Damper 2	6EE-G4366-00	1
18-99157	Gasket, Water Pump	6EG-G4315-00	1
18-4547	Cup, Insert	6EG-G4322-00	1
18-4574	Plate, Wear	6EG-G4323-00	1
18-9089	Plate	6EG-G4328-00	2
18-8911	Impeller	6L5-44352-00	1
18-43717	Pin, Dowel (688)	93604-10M03	2
18-8406	Bolt W/ Washer	97595-06535	4



18-4533
WATER PUMP KIT
Without Housing
Replaces: 65N-W0078-A0-00
Fits: B115 (1998-99), D150 (1997-98), DX150 (1999-05)

— CONTAINS —

Part #	Description	O.E. #	Qty.
18-3519	Cup, Insert	61A-44322-02	1
18-0453	Gasket, Water Pump	65N-44315-A0	1
18-0408	Plate, Wear	65N-44323-00	1
18-3071	Impeller	6E5-44352-01	1
NSS	Bolt, With Washer	90119-08M14	4
18-3302	Key, Woodruff (6E5)	90280-04M05	1
18-7483	O-Ring (6G8)	93210-37M67	1
18-7485	O-Ring (6E5)	93210-86M38	1
NSS	Pin, Dowel (614)	93606-12019	2



18-4534
WATER PUMP KIT
Without Housing
Replaces: 69M-WG078-00-00
Fits: F2.5 (2003-15)

— CONTAINS —

Part #	Description	O.E. #	Qty.
18-3166	Seal, Water Damper 2	6E0-44366-00	1
18-7119	O-Ring	93210-33M85	1
18-3164	Cup, Insert	6L5-44322-00	1
18-8911	Impeller	6L5-44352-00	1
18-0409	Plate, Wear	69M-G4323-00	1
18-43716	Pin, Dowel	93604-18080	2
18-71330	O-Ring	93210-05001	1
18-2607	Bolt	97095-06040	4
18-9091	Plate	69M-G4328-00	1

YAMAHA 4-STROKE WATER PUMP APPLICATION CHART

HP Model	Year	Impeller	Cup	Plate	Housing	Damper Seal	Water Pump Cover	Kit without Housing	Kit with Housing
F2.5	2003-15	18-8911	-	18-0409	-	18-3166	-	18-4534	-
F2.5	2016-18	18-8911	18-4547	18-4574	-	18-1840	-	18-4532	-
4	1984-99	18-3073	-	-	-	-	-	-	-
F4	1999-13	18-3073	-	-	-	-	-	-	-
F4	2014-18	18-3073	18-4546	18-4573	18-4567	18-1840	-	18-3473	-
F6	2001-08	18-8910	18-3444	18-3142	18-3356	18-3176	-	18-3450	18-3410
F6	2009-17	18-3073	18-4546	18-4573	18-4567	-	-	18-3473	-
F8	2001-17	18-8910	18-3444	18-3142	18-3356	18-3176	-	18-3450	18-3410
T8	2001-10	18-3040	18-3444	18-3142	18-3356	18-3176	-	18-3450	18-3410
F9.9	1985-05	18-3074	-	-	-	18-1834	-	18-3148	18-3411
F9.9	2005-06	18-3040	18-3444	18-3195	18-3356	18-1833	-	18-3433	18-3412
F9.9	2007-17	18-8910	18-3444	18-3142	18-3356	18-3176	-	18-3450	18-3410

APPLICATION CONTINUES ON NEXT PAGE

YAMAHA 4-STROKE WATER PUMP APPLICATION CHART

HP Model	Year	Impeller	Cup	Plate	Housing	Damper Seal	Water Pump Cover	Kit without Housing	Kit with Housing
FT9.9	1985-90	18-3074	-	-	-	18-1834	-	18-3148	18-3411
T9.9	1985-05	18-3074	-	-	-	18-1834	-	18-3148	18-3411
T9.9	2005-06	18-3040	18-3444	18-3195	18-3356	18-1833	-	18-3433	18-3412
T9.9	2007-17	18-3040	18-3444	18-3142	18-3356	18-3176	-	18-3475	-
F15	1998-06	18-3040	18-3444	18-3195	18-3356	18-1833	-	18-3433	18-3412
F15C	2006-18	18-3040	18-3444	18-3142	18-3484	18-1836	-	18-3479	-
F20	2006-18	18-3040	18-3444	18-3142	18-3484	18-1836	-	18-3479	-
F25	1998-05	18-3068	18-3443	18-3194	18-3185	-	-	-	18-3432
F25A	2009-17	18-3068	18-3443	18-3194	18-3185	-	-	-	18-3432
F25B	2012-17	18-3068	18-3443	18-3194	18-3185	-	-	-	18-3432
F25C	2016-17	18-3065	18-4548	18-4576	18-3486	18-1837	-	18-4527	-
T25	2001-06, 2009-17	18-3068	18-3449	18-3196	-	-	-	18-3440	18-3413
F30	2001-05	18-3068	18-3449	18-3196	-	-	-	18-3440	18-3413
F30	2013-17	18-3068	18-3449	18-3186	18-3413	18-1828	18-9083	18-3490	-
F40	1999	18-3069	18-3449	18-3186	-	-	-	18-3434	18-3415
F40	2000-06	18-3068	18-3449	18-3196	-	-	-	18-3440	18-3413
F40A	2008-17	18-3068	18-3449	18-3186	18-3413	18-1828	18-9083	18-3490	-
F40B	2007-08	18-3068	18-3449	18-3196	-	-	-	18-3440	18-3413
F50	1995-17	18-3069	18-3449	18-3186	-	-	-	18-3434	18-3415
F50	1996	18-3069	18-3435	-	-	-	-	18-3428-1	18-3461
F50	1997	18-3069	18-3435	-	-	-	-	18-3465	18-3466
T50	1996	18-3069	18-3435	-	-	-	-	18-3428-1	18-3461
T50	1997-17	18-3069	18-3435	-	-	-	-	18-3465	18-3466
F60	2002-17	18-3069	18-3449	18-3186	-	-	-	18-3434	18-3415
T60	2003-17	18-3069	18-3435	-	-	-	-	18-3465	18-3466
F70A	2010-17	18-3069	18-3449	-	18-3485	-	-	18-3494	-
F75A	2003-17	18-3042	18-3162	18-3143	-	18-1830	-	18-3451	18-3409
F75B	2017	18-3071	18-3519	18-3521	18-3173-1	18-1835	18-9081	18-3442	18-3523-1
F80	1999-03	18-3042	18-3162	18-3143	-	18-1830	-	18-3451	18-3409
F90	2003-11	18-3042	18-3162	18-3143	-	18-1830	-	18-3451	18-3409
F90A	2012-17	18-3042	18-3162	18-3143	-	18-1830	-	18-3451	18-3409
F90B	2016-17	18-3071	18-3519	18-3521	18-3173-1	18-1835	18-9081	18-3442	18-3523-1
VF90A	2018	18-3071	18-3519	18-3521	18-3173-1	18-1835	18-9081	18-3442	18-3523-1
F100	1999-03	18-3042	18-3162	18-3143	-	18-1830	-	18-3451	18-3409
F115/LF115	2000-01	18-3071	18-3333	18-3344	18-3173-1	18-1835	18-9081	-	18-3313-1
F115/LF115	2002-17	18-3071	18-3519	18-3521	18-3173-1	18-1835	18-9081	18-3442	18-3523-1
VF115	2015-17	18-3071	18-3519	18-3521	18-3173-1	18-1835	18-9081	18-3442	18-3523-1
F150 / LF150	2004-11	18-3071	18-3519	18-3345	18-3173-1	18-1835	18-9081	18-3395	18-3396-1
F150A / LF150A	2012-14	18-3071	18-3519	18-3345	18-3173-1	18-1835	18-9081	18-3395	18-3396-1
F150B / LF150B	2015-18	18-3071	18-3519	18-3345	18-3173-1	18-1835	18-9081	18-3395	18-3396-1
F150C / LF150C	2017	18-3071	18-3519	18-3345	18-3173-1	18-1835	18-9081	18-3395	18-3396-1
VF150	2013-17	18-3071	18-3519	18-3345	18-3173-1	18-1835	18-9081	18-3395	18-3396-1
VF150A	2018	18-3071	18-3519	18-3345	18-3173-1	18-1835	18-9081	18-3395	18-3396-1
F175A	2014-18	18-3071	18-3519	18-3345	18-3173-1	18-1835	18-9081	18-3395	18-3396-1
F175 / LF175C	2017	18-3071	18-3519	18-3345	18-3173-1	18-1835	18-9081	18-3395	18-3396-1
VF175	2015-18	18-3071	18-3519	18-3345	18-3173-1	18-1835	18-9081	18-3395	18-3396-1
F200/LF200	2002-10	18-3071	18-3519	18-3345	18-3173-1	18-1835	18-9081	18-3395	18-3396-1
F200A/LF200A	2010-17	18-3071	18-3519	18-3345	18-3173-1	18-1835	18-9081	18-3395	18-3396-1
F200B/LF200B	2012-18	18-3071	18-3519	18-3345	18-3173-1	18-1835	18-9081	18-3395	18-3396-1
F200C/LF200C	2013-18	18-3071	18-3519	18-3345	18-3173-1	18-1835	18-9081	18-3395	18-3396-1
VF200	2009-18	18-3071	18-3519	-	18-3173-1	18-1835	18-9081	-	-
F225 / LF225	2002-10	18-3071	18-3519	18-3345	18-3173-1	18-1835	18-9081	18-3395	18-3396-1
F225 / LF225	2007-09	18-3071	18-3519	18-3518	18-3173-1	18-1835	18-9081	18-3515	-
F225A/LF225A (3.3L)	2011-17	18-3071	18-3519	18-3345	18-3173-1	18-1835	18-9081	18-3395	18-3396-1
F225A/LF225A (4.2L)	2010-17	18-45617-1	18-3457	18-3459	18-3482	18-1829	18-9082	18-3470	18-3471
F225B/LF225B (4.2L)	2016-17	18-45617-1	18-3457	18-3459	18-3482	18-1829	18-9082	18-3470	18-3471
F225B/LF225B (3.3L)	2016-17	18-3071	18-3519	18-3345	18-3173-1	18-1835	18-9081	18-3395	18-3396-1

CHART CONTINUED ON NEXT PAGE

YAMAHA 4-STROKE WATER PUMP APPLICATION CHART

HP Model	Year	Impeller	Cup	Plate	Housing	Damper Seal	Water Pump Cover	Kit without Housing	Kit with Housing
VF225 (4.2L)	2009-18	18-3071	18-3519	-	18-3173-1	18-1835	18-9081	18-3474	-
F250 / LF250 (3.3L)	2005	18-3071	18-3519	18-3345	18-3173-1	18-1835	18-9081	18-3395	18-3396-1
F250 / LF250 (3.3L)	2006-11	18-3071	18-3519	18-3518	18-3173-1	18-1835	18-9081	18-3515	-
F250A / LF250A (3.3L)	2010-17	18-3071	18-3519	18-3518	18-3173-1	18-1835	18-9081	18-3515	-
F250A / LF250A (4.2L)	2014-17	18-45617-1	18-3457	18-3459	18-3482	18-1829	18-9082	18-3470	18-3471
F250B / LF250B (3.3L)	2008-09	18-3071	18-3519	18-3518	18-3173-1	18-1835	18-9081	18-3515	-
F250B / LF250B (4.2L)	2016-17	18-45617-1	18-3457	18-3459	18-3482	18-1829	18-9082	18-3470	18-3471
FL250	2010	18-45617-1	18-3457	18-3459	18-3482	18-1829	18-9082	18-3470	18-3471
VF250	2009-18	18-3071	18-3519	-	18-3173-1	18-1835	18-9081	18-3474	-
VF250 (XA Models)	2015-18	18-45617-1	18-3457	18-3459	18-3482	18-1829	18-9082	18-3470	18-3471
F300 / LF300 (5.3L)	2007-09	18-8925	18-3457	18-0421	18-3483	18-1835	18-9081	18-3477	-
F300 / LF300 (4.2L)	2010-18	18-45617-1	18-3457	18-3459	18-3482	18-1829	18-9082	18-3470	18-3471
FL300	2010, 2016	18-45617-1	18-3457	18-3459	18-3482	18-1829	18-9082	18-3470	18-3471
F350 / LF350 (5.3L)	2007-09	18-8925	18-3457	18-0421	18-3483	18-1835	18-9081	18-3477	-
F350A / LF350A (5.3L)	2010-11	18-8925	18-3457	18-0421	18-3483	18-1835	18-9081	18-3477	-
F350B / LF350B (5.3L)	2012-15	18-8925	18-3457	18-0421	18-3483	18-1835	18-9081	18-3477	-
F350C / LF350C (5.3L)	2016-18	18-8925	18-3457	18-0421	18-3483	18-1835	18-9081	18-3477	-
FL350 (5.3L)	2010	18-8925	18-3457	18-0421	18-3483	18-1835	18-9081	18-3477	-

YAMAHA 2-STROKE WATER PUMP APPLICATION CHART

HP Model	Year	Impeller	Cup	Plate	Housing	Damper Seal	Water Pump Cover	Kit without Housing	Kit with Housing
2	1984-87	18-3072	18-3328	18-3357	-	18-3166	-	18-3463	-
2	1988-02	18-3072	18-3328	18-3357	-	18-3166	-	18-3462	-
3	1988-02	18-8911	18-3164	18-3163	-	18-3166	-	-	-
4	1984-99	18-3073	-	-	-	18-3166	-	-	-
5	1984-02	18-3073	-	-	-	18-3166	-	-	-
6	1986-00	18-3066	18-3456	-	-	18-1833	-	18-3460	-
8	1984-09	18-3066	18-3456	-	-	18-1833	-	18-3460	-
9.9	1984-95	18-3074	-	-	-	18-1834	-	18-3148	18-3411
9.9	1996-09	18-3040	18-3444	18-3195	-	18-1833	-	18-3433	18-3412
15	1984-95	18-3074	-	-	-	18-1834	-	18-3148	18-3411
15	1996-09	18-3040	18-3444	18-3195	-	18-1833	-	18-3433	18-3412
20	1996-97	18-3065	-	-	-	-	-	18-3431	-
25	1984-85	18-3067	-	-	-	-	-	-	18-3426
25	1986-87	18-3067	-	-	-	-	-	-	18-3427
25 (2 cyl)	1988-09	18-3065	-	-	-	-	-	18-3431	-
25 (3 cyl)	1997-02	18-3068	-	-	-	-	-	-	-
C25	1991-97	18-3067	-	-	-	-	-	-	18-3427
CV25	1990	18-3067	-	-	-	-	-	-	18-3427
30	1984-85	18-3067	-	-	-	-	-	-	18-3426
30	1986	18-3067	-	-	-	-	-	-	18-3427
30	1987-02	18-3068	18-3435	18-3436	-	-	-	18-3430	-
C30	1991-92	18-3067	-	-	-	-	-	-	18-3427
C30	1993-97	18-3068	18-3443	18-3194	18-3185	6L2-44367-00-00	-	-	18-3432
CV30	1989-90	18-3067	-	-	-	-	-	-	-
40	1984-87	18-3068	18-3435	18-3436	-	-	-	18-3429	18-3408
40	1988-94	18-3068	18-3435	18-3436	-	-	-	18-3429	-
40	1995-05	18-3069	18-3449	18-3186	-	-	-	18-3434	18-3415
C40	1990-91	18-3088	-	-	-	-	-	18-3397	-
C40	1992-97	18-3088	-	-	-	-	-	18-3397	18-3398
C40	1997-03	18-3069	18-3449	18-3186	-	-	-	18-3434	18-3415
P40	1998	18-3069	18-3449	18-3186	-	-	-	18-3434	18-3415
E48	1995-2000	18-3069	-	-	-	-	-	-	-
50	1984-87	18-3068	18-3435	18-3436	-	-	-	18-3429	18-3408
50	1988-94	18-3068	18-3435	18-3436	-	-	-	18-3429	-
50	1995-09	18-3069	18-3449	18-3186	-	-	-	18-3434	18-3415

CHART CONTINUED ON NEXT PAGE















YAMAHA 2-STROKE WATER PUMP APPLICATION CHART

HP Model	Year	Impeller	Cup	Plate	Housing	Damper Seal	Water Pump Cover	Kit without Housing	Kit with Housing
C50	1998-01	18-3069	18-3449	18-3186	-	-	-	18-3434	18-3415
PRO 50	1987	18-3068	18-3435	18-3436	-	-	-	18-3429	18-3408
PRO 50	1988-90	18-3068	18-3435	18-3436	-	-	-	18-3429	-
P50	1991-94	18-3068	18-3435	18-3436	-	-	-	18-3429	-
P50	1995-96	18-3069	18-3449	18-3186	-	-	-	18-3434	-
50 Jet	1986-95	18-3068	-	-	-	-	-	-	-
C55	1991-95	18-3069	18-3435	18-3436	-	-	-	18-3425	-
CV55	1989-90	18-3069	18-3435	18-3436	-	-	-	18-3425	-
60	2001-03	18-3069	18-3435	-	-	-	-	18-3465	-
60	2004-05	18-3070	-	-	18-3171	18-1830	-	18-3370	18-3371
C60	1996-01	18-3069	18-3435	-	-	-	-	18-3465	18-3466
E60	1995-96	18-3069	18-3435	-	-	-	-	18-3465	18-3466
E60	1997-00	18-3069	-	-	-	-	-	-	-
P60	1991	18-3069	18-3435	-	-	-	-	18-3428-1	18-3461
P60	1992-99	18-3069	18-3435	-	-	-	-	18-3465	18-3466
70	1984-91	18-3069	18-3435	-	-	-	-	18-3428-1	18-3461
70	1992-03	18-3069	18-3435	-	-	-	-	18-3465	18-3466
70	2004-09	18-3070	-	-	18-3171	18-1830	-	18-3370	18-3371
C70	2000-01	18-3069	18-3435	-	-	-	-	18-3465	18-3466
C75	1994-99	18-3070	-	-	18-3171	18-1830	-	18-3370	18-3371
E75	1995-00	18-3070	-	-	-	-	-	-	-
P75	1996-99	18-3070	-	-	-	-	-	-	-
C80	1997	18-3070	-	-	-	-	-	-	-
C85	1991-96	18-3070	-	-	18-3171	18-1830	-	18-3370	18-3371
CV85	1989-90	18-3070	-	-	18-3171	18-1830	-	18-3370	18-3371
90	1984-09	18-3070	-	-	18-3171	18-1830	-	18-3370	18-3371
90 Jet	1986-89	18-3070	-	-	-	-	-	-	-
90 Jet	1992-94	18-3071	-	-	-	-	-	-	-
B90	1997-99	18-3070	-	-	-	18-1830	-	-	-
C90	1997-01	18-3070	-	-	18-3171	18-1830	-	18-3370	18-3371
115	2002-09	18-3071	18-3333	18-3344	18-3173-1	18-1835	18-9081	18-3312	18-3313-1
115	1995-01	18-3071	18-3333	18-3344	18-3173-1	18-1835	18-9081	18-3312	18-3313-1
115 (6N6), (6E5)	1984-94	18-3071	-	18-3344	18-3170	18-1835	-	18-3372	18-3373
115 (6N6)	1994	18-3071	18-3333	18-3344	18-3173-1	18-1835	18-9081	18-3312	18-3313-1
B115	1998-99	18-3071	18-3519	18-0408	18-3173-1	18-1835	18-9081	18-4533	-
C115	1991-92	18-3071	-	18-3344	18-3170	18-1835	-	18-3372	18-3373
C115	1993-00	18-3071	18-3333	18-3344	18-3173-1	18-1835	18-9081	18-3312	18-3313-1
P115 (62A)	1993-96	18-3071	18-3333	18-3344	18-3173-1	18-1835	18-9081	18-3312	18-3313-1
S115	1996-99	18-3071	18-3519	18-3344	18-3173-1	18-1835	18-9081	18-3312	18-3313-1
130 (6L1), (6N7)	1988-92	18-3071	-	18-3344	18-3170	18-1835	-	18-3372	18-3373
130 (6N7)	1993-96	18-3071	18-3333	18-3344	18-3173-1	18-1835	18-9081	18-3312	18-3313-1
130	1997-04	18-3071	18-3519	18-3344	18-3173-1	18-1835	18-9081	18-3312	18-3313-1
L130 (6L6), (6N4)	1989-92	18-3071	-	18-3344	18-3170	18-1835	-	18-3372	18-3373
L130 (6N4)	1993-96	18-3071	18-3333	18-3344	18-3173-1	18-1835	18-9081	18-3312	18-3313-1
L130	1997-01	18-3071	18-3519	18-3344	18-3173-1	18-1835	18-9081	18-3312	18-3313-1
S130	1996-99	18-3071	18-3519	18-3344	18-3173-1	18-1835	18-9081	18-3312	18-3313-1
150 (6R2), (6G4)	1984-91	18-3071	-	18-3344	18-3170	18-1835	-	18-3310	18-3311
150 (6R2)	1992-09	18-3071	18-3333	18-3345	18-3173-1	18-1835	18-9081	18-3395	18-3396-1
C150 (6E5)	1996-99	18-3071	18-3333	18-3345	18-3173-1	18-1835	18-9081	18-3395	18-3396-1
D150	1997-98	18-3071	18-3519	18-0408	18-3173-1	18-1835	18-9081	18-4533	-
DX150	1999-05	18-3071	18-3519	18-0408	18-3173-1	18-1835	18-9081	18-4533	-
L150 (6R0), (6K0)	1986-91	18-3071	-	18-3344	18-3170	18-1835	-	18-3310	18-3311
L150 (6R0)	1992-99	18-3071	18-3333	18-3345	18-3173-1	18-1835	18-9081	18-3395	18-3396-1
LX150	1999-01	18-3071	18-3333	18-3345	18-3173-1	18-1835	18-9081	18-3395	18-3396-1
P150	1986-91	18-3071	-	18-3344	18-3170	18-1835	-	18-3310	18-3311
P150	1992-99	18-3071	18-3333	18-3345	18-3173-1	18-1835	18-9081	18-3395	18-3396-1



CHART CONTINUED ON NEXT PAGE

YAMAHA 2-STROKE WATER PUMP APPLICATION CHART

HP Model	Year	Impeller	Cup	Plate	Housing	Damper Seal	Water Pump Cover	Kit without Housing	Kit with Housing
PRO V150 (6J9)	1986-89	18-3071	-	18-3344	18-3170	18-1835	-	18-3310	18-3311
PRO V150D (6N9)	1990	18-3071	-	18-3344	18-3170	18-1835	-	18-3310	18-3311
PX150	1999	18-3071	18-3333	18-3345	18-3173-1	18-1835	18-9081	18-3395	18-3396-1
S150	1996-99	18-3071	18-3333	18-3345	18-3173-1	18-1835	18-9081	18-3395	18-3396-1
SX150	1999-04	18-3071	18-3333	18-3345	18-3173-1	18-1835	18-9081	18-3395	18-3396-1
V150	2000-08	18-3071	18-3333	18-3345	18-3173-1	18-1835	18-9081	18-3395	18-3396-1
VX150	2000-04	18-3071	18-3333	18-3345	18-3173-1	18-1835	18-9081	18-3395	18-3396-1
VZ150	2000-14	18-3071	18-3333	18-3345	18-3173-1	18-1835	18-9081	18-3395	18-3396-1
Z150/LZ150	2000-05	18-3071	18-3333	18-3345	18-3173-1	18-1835	18-9081	18-3395	18-3396-1
175 (6G5)	1984-91	18-3071	-	18-3344	18-3170	18-1835	-	18-3310	18-3311
175 (6R3)	1992-00	18-3071	18-3333	18-3345	18-3173-1	18-1835	18-9081	18-3395	18-3396-1
P175 (62H)	1994-99	18-3071	18-3333	18-3345	18-3173-1	18-1835	18-9081	18-3395	18-3396-1
S175	1996-99	18-3071	18-3333	18-3345	18-3173-1	18-1835	18-9081	18-3395	18-3396-1
V175	2000	18-3071	18-3333	18-3345	18-3173-1	18-1835	18-9081	18-3395	18-3396-1
VZ175	2001-12	18-3071	18-3333	18-3345	18-3173-1	18-1835	18-9081	18-3395	18-3396-1
Z175	2001-05	18-3071	18-3333	18-3345	18-3173-1	18-1835	18-9081	18-3395	18-3396-1
200 (6G6), (6R4)	1984-91	18-3071	-	18-3344	18-3170	18-1835	-	18-3310	18-3311
200 (6R4)	1992-99	18-3071	18-3333	18-3345	18-3173-1	18-1835	18-9081	18-3395	18-3396-1
L200 (6K1), (6R1)	1986-91	18-3071	-	18-3344	18-3170	18-1835	-	18-3310	18-3311
L200	1992-99	18-3071	18-3333	18-3345	18-3173-1	18-1835	18-9081	18-3395	18-3396-1
LX200	1999-01	18-3071	18-3333	18-3345	18-3173-1	18-1835	18-9081	18-3395	18-3396-1
LZ200	2000-12	18-3071	18-3333	18-3345	18-3173-1	18-1835	18-9081	18-3395	18-3396-1
P200	1991-99	18-3071	18-3333	18-3345	18-3173-1	18-1835	18-9081	18-3395	18-3396-1
S200	1996-99	18-3071	18-3333	18-3345	18-3173-1	18-1835	18-9081	18-3395	18-3396-1
SX200	1999-05	18-3071	18-3333	18-3345	18-3173-1	18-1835	18-9081	18-3395	18-3396-1
V200	1998-99	18-3071	18-3333	18-3345	18-3173-1	18-1835	18-9081	18-3395	18-3396-1
VX200	2000-05	18-3071	18-3333	18-3345	18-3173-1	18-1835	18-9081	18-3395	18-3396-1
VZ200	2001-04	18-3071	18-3333	18-3345	18-3173-1	18-1835	18-9081	18-3395	18-3396-1
VZ200	2005-09	18-3071	18-3519	18-3520	18-3173-1	18-1835	18-9081	18-3516	-
Z200	2000-12	18-3071	18-3333	18-3345	18-3173-1	18-1835	18-9081	18-3395	18-3396-1
V6 Special (6G7)	1984-86	18-3071	-	18-3344	18-3170	18-1835	-	18-3310	18-3311
V6 Excel (6K7)	1987-89	18-3071	-	18-3344	18-3170	18-1835	-	18-3310	18-3311
225 (6R5)	1990-91	18-3071	-	18-3344	18-3170	18-1835	-	18-3310	18-3311
225	1992-97	18-3071	18-3333	18-3345	18-3173-1	18-1835	18-9081	18-3395	18-3396-1
L225	1994-99	18-3071	18-3333	18-3345	18-3173-1	18-1835	18-9081	18-3395	18-3396-1
LX225	2000-03	18-3071	18-3333	18-3345	18-3173-1	18-1835	18-9081	18-3395	18-3396-1
S225	1996-99	18-3071	18-3333	18-3345	18-3173-1	18-1835	18-9081	18-3395	18-3396-1
SX225	2000-03	18-3071	18-3333	18-3345	18-3173-1	18-1835	18-9081	18-3395	18-3396-1
V225	1998-99	18-3071	18-3333	18-3345	18-3173-1	18-1835	18-9081	18-3395	18-3396-1
VX225	2000-04	18-3071	18-3333	18-3345	18-3173-1	18-1835	18-9081	18-3395	18-3396-1
VZ225	2003-09	18-3071	18-3519	18-3520	18-3173-1	18-1835	18-9081	18-3516	-
250	1990-95	18-3071	18-3333	18-3345	18-3173-1	18-1835	18-9081	18-3395	18-3396-1
L250	1990-99	18-3071	18-3333	18-3345	18-3173-1	18-1835	18-9081	18-3395	18-3396-1
LX250	2000-03	18-3071	18-3333	18-3345	18-3173-1	18-1835	18-9081	18-3395	18-3396-1
LZ250	2003-05	18-3071	18-3333	18-3345	18-3173-1	18-1835	18-9081	18-3395	18-3396-1
S250	1996-99	18-3071	18-3333	18-3345	18-3173-1	18-1835	18-9081	18-3395	18-3396-1
SX250	2000-03	18-3071	18-3333	18-3345	18-3173-1	18-1835	18-9081	18-3395	18-3396-1
VX250	2002-04	18-3071	18-3333	18-3345	18-3173-1	18-1835	18-9081	18-3395	18-3396-1
VZ250	2003-09	18-3071	18-3519	18-3520	18-3173-1	18-1835	18-9081	18-3516	-
LZ300	2004-06	18-3071	18-3519	-	18-3173-1	18-1835	18-9081	18-3515	-
VZ300	2004-09	18-3071	18-3519	18-3520	18-3173-1	18-1835	18-9081	18-3516	-
Z250	2003-05	18-3071	18-3333	18-3345	18-3173-1	18-1835	18-9081	18-3395	18-3396-1
Z300	2004-06	18-3071	18-3519	-	18-3173-1	18-1835	18-9081	18-3515	-

 <p>18-3524 THERMOSTAT</p> <p>Replaces: 6CE-12411-00-00 Fits: F225/LF225 (2010-2016), F250/LF250 (2010-2016), VF250 (2015), F300/LF300 (2010-2016), FL250/FL300 (2010)</p>	<p>50°C</p>  <p>18-3525 THERMOSTAT</p> <p>Replaces: 60V-12411-00 Fits: F115(2005-14), LF115(2005-14), LZ250(2003-05), LZ300(2004-06), VZ200(2005-09), VZ225(2005-09), VZ250(2005-09), VZ300(2005-09), Z250(2003-05), Z300(2004-06)</p>	<p>60°C</p>  <p>18-3625 THERMOSTAT (Seal Included)</p> <p>Replaces: 6F5-12411-03-00 9.9EL, 9.9ES, 15EL, 15ES (1986-1995), 9.9L, 9.9S, 15L, 15S (1986-1990), 9.9M, 15ML, 15MS, C55EL (1991-1995), C25EL, C40EL (1991-1997), C25ML (1993-1997), C25MS, C40MS, C40PL (1992-1997), C30EL (1991-1992), CV30EL (1989-1990), C40ML (1994-1995), C55TL (1993-1995), CV25EL, CV25EM, CV40EL (1990), CV55EL (1989)</p>
<p>50°C</p>  <p>18-3623 THERMOSTAT (Seal Included)</p> <p>Replaces: 6E5-12411-02-00 8MSH-0405, 8MSH-0406, 8MSH-0407, 8MSH-0608, 8MSHD-2005</p>	<p>60°C</p>  <p>18-3632 THERMOSTAT</p> <p>Replaces: 67F-12411-01-00 Fits: F75-F250 (2005 & Up)</p>	<p>New</p>  <p>18-3634 THERMOSTAT</p> <p>Replaces: 6AW-12411-00-00 Fits: F300/LF300 (2007-09), F350/LF350 (2007-09), F350A/LF350A (2010-11), F350B/LF350B (2012-15), F350C/LF350C (2016-18)</p>
<p>New</p>  <p>18-3636 THERMOSTAT</p> <p>Replaces: 6DA-12411-01-00 Fits: F150C/LF150C (2017), VF150 (2013-17), VF150A (2018), F175A (2014-18), F175C/LF175C (2017), VF175 (2015-18), F200B/LF200B (2012-18), F200C/LF200C (2013-18)</p>	<p>New</p>  <p>18-3637 THERMOSTAT</p> <p>Replaces: 6CB-12411-10-00 Fits: VF200LA/VF225LA/VF250LA (2011-18)</p>	<p>New</p>  <p>18-3639 THERMOSTAT</p> <p>Replaces: 6EK-12411-00-00 Fits: F115/LF115/VF115 (2014-18)</p>
<p>New</p>  <p>18-3641 THERMOSTAT</p> <p>Replaces: 6FP-12411-00-00 Fits: F75B (2017-18), F90B (2016-18), VF90A (2018)</p>	<p>50°C</p>  <p>18-3540 THERMOSTAT</p> <p>Replaces: 6E5-12411-30-00 Fits: 9.9-15 (1996-06), 20 (1996-97), 25 (1988-95), 30 3-cyl (1987-91), 40 (1986-05), C40 3-cyl (1998-02), 50 (1986-05), C50 (1998-01), P50 (1987-96), 115 (1984-05), B115 (1988-99), C115 (1991-00), P115 (1993-96), S115/S130 (1996-98), 130/L130 (1988-05), 150/175/200 (1986-05), C150 (1996-99), D150/DX150 (1997-05), L150/L200 (1986-99), LX150/LX200 (1999-01), P150 (1986-99), PX150 (1999), SX150/SX200 (1999-04), V150 (2000-05), VX150 (2000-05), VZ150/VZ175/VZ200 (2001-05), Z150/Z175/Z200 (2000-05), P200 (1991-93), V200/V225 (1998-99), VX200/VX225 (2000-05), V6 Special (1984-86), V6 Excel (1987-89), 225 2.6L (1990-97), 250/L250 2.6L (1990-95) Note: Will not fit 3.1 L</p>	
<p>60°C</p>  <p>18-3541 THERMOSTAT</p> <p>Replaces: 66M-12411-01-00 Fits: F6 (2001-05), F8 (2001-05), T8 (2001-05), F9.9 (1985-05), T9.9 (1985-05), T9.9 (1991-05), F15 (1998-05), F25 (1998-05), T25 (2001-05), F30 (2001-05), F40 4cyl (1999), F40 3cyl (2000-05), F50 (1995-05), T50 (1996-05), F60 (2002-05), T60 (2003-05), F80 (1999-00), F100 (1999-00)</p>	<p>50°C</p>  <p>18-3622 THERMOSTAT KIT</p> <p>Replaces: 6H3-12411-11-00 60TLR-0405, 70TLR-0405, 70TLR-0406, 70TLR-0407, 70TLR-0408</p>	<p>50°C</p>  <p>18-3624 THERMOSTAT KIT</p> <p>Replaces: 69M-12411-01-00 F2.5MSH-0405, F2.5MSH-0406, F2.5MSH-0407, F2.5MSH0608, F2.5MSHD-2005</p>

APPLICATION STARTS ON NEXT PAGE

 <p>①18-3608D Display Package</p> <p>18-3608 THERMOSTAT KIT Fits: 115 (1991-02), C115 (1991-99), P115 (1993-96), S115 (1996-99), 130 (1991-02), L130 (1991-00), S130 (1996-99), 150 (1991-02), C150 (1996-99), L150 (1991-99), P150 (1991-99), S150 (1996-99), V150 (2000-02), Z150 (2001-02), 175 (1991-95, 97), P175 (1994-99), V175 (2000), Z175 (2001-02), 200 (1991-98), L200 (1991-99), P200 (1991-99), S200 (1996-99), V200 (1998-99), Z200 (2001-02), 225 (1991-97), V225 (1998-99)</p> <p style="text-align: center;">— CONTAINS—</p> <table border="1" style="width: 100%; border-collapse: collapse;"> <thead> <tr> <th>Part #</th> <th>Desc.</th> <th>O.E. #</th> <th>Qty.</th> </tr> </thead> <tbody> <tr> <td>18-3540</td> <td>Thermostat</td> <td>6E5-12411-30-00</td> <td>1</td> </tr> <tr> <td>18-0844</td> <td>Gasket</td> <td>688-12414-A1-00</td> <td>1</td> </tr> </tbody> </table>	Part #	Desc.	O.E. #	Qty.	18-3540	Thermostat	6E5-12411-30-00	1	18-0844	Gasket	688-12414-A1-00	1	 <p>①18-3609D Display Package</p> <p>18-3609 THERMOSTAT KIT Fits: 25 (1996-98,2001-02), 40 (1991-99, 01), C40 (1997-02), P40 (1998), 50 (1991-97, 1999-02), C50 (1998-01), P50 (1991-96), L225 (1994-99), S225 (1996-99), 250 (1991-95), L250 (1991-99), S250 (1996-99)</p> <p style="text-align: center;">— CONTAINS—</p> <table border="1" style="width: 100%; border-collapse: collapse;"> <thead> <tr> <th>Part #</th> <th>Desc.</th> <th>O.E. #</th> <th>Qty.</th> </tr> </thead> <tbody> <tr> <td>18-3540</td> <td>Thermostat</td> <td>6E5-12411-30-00</td> <td>1</td> </tr> <tr> <td>18-0829</td> <td>Gasket</td> <td>61A-12414-A0-00, 6J8-12414-A0-00</td> <td>1</td> </tr> </tbody> </table>	Part #	Desc.	O.E. #	Qty.	18-3540	Thermostat	6E5-12411-30-00	1	18-0829	Gasket	61A-12414-A0-00, 6J8-12414-A0-00	1	 <p style="text-align: right;">60°C</p> <p>18-3611 THERMOSTAT KIT Fits: 15 (2006), F15 (1998-06), F25 (1999-06), F30 (2001-06), F40 (1999-06), F50 (1996-06), F60 (2002-06), F9.9 (2005-06), T25 (2001-06), T50 (1996-06), T60 (2003-06), T9.9 (2005-06)</p> <p style="text-align: center;">— CONTAINS—</p> <table border="1" style="width: 100%; border-collapse: collapse;"> <thead> <tr> <th>Part #</th> <th>Desc.</th> <th>O.E. #</th> <th>Qty.</th> </tr> </thead> <tbody> <tr> <td>18-3541</td> <td>Thermostat</td> <td>66M-12411-01-00</td> <td>1</td> </tr> <tr> <td>18-0835</td> <td>Gasket</td> <td>62Y-12414-00-00</td> <td>1</td> </tr> </tbody> </table>	Part #	Desc.	O.E. #	Qty.	18-3541	Thermostat	66M-12411-01-00	1	18-0835	Gasket	62Y-12414-00-00	1
Part #	Desc.	O.E. #	Qty.																																			
18-3540	Thermostat	6E5-12411-30-00	1																																			
18-0844	Gasket	688-12414-A1-00	1																																			
Part #	Desc.	O.E. #	Qty.																																			
18-3540	Thermostat	6E5-12411-30-00	1																																			
18-0829	Gasket	61A-12414-A0-00, 6J8-12414-A0-00	1																																			
Part #	Desc.	O.E. #	Qty.																																			
18-3541	Thermostat	66M-12411-01-00	1																																			
18-0835	Gasket	62Y-12414-00-00	1																																			

YAMAHA 2-STROKE THERMOSTAT APPLICATION

HP/Model	Year	Thermostat	Gasket	Thermostat Kit	Qty. Per Engine
4	1986-88	18-3540	—	—	1
4	1989-99	18-3623	—	—	1
5	1995-02	18-3623	—	—	1
6	1986-88	18-3540	—	—	1
6	1989-00	18-3623	—	—	1
8	1986-88	18-3540	—	—	1
8	1989-09	18-3623	—	—	1
9.9	1986-95	18-3625	18-0836	—	1
9.9	1996-09	18-3540	18-0836	—	1
15	1984-85	—	18-0836	—	1
15	1986-95	18-3625	18-0836	—	1
15	1996-09	18-3540	18-0836	—	1
20	1996-97	18-3540	18-0829	18-3609	1
25 (2 cyl)	1984-87	—	18-0232	—	1
25 (2 cyl)	1988-09	18-3540	18-0829	18-3609	1
C25	1991-97	18-3625	18-0232	—	1
CV25	1990	18-3625	18-0232	—	1
30	1984-85	—	18-0232	—	1
30	1986	18-3625	18-0835	—	1
30	1987-88	18-3540	18-0829	18-3609	1
30	1989-91	18-3623	18-0829	—	1
30	1992-02	—	18-0829	—	1
C30	1991-92	18-3625	18-0232	—	1
C30	1993-94, 1996-97	18-3623	18-0232	—	1
40	1984-85	—	18-0829	—	1
40	1986-05	18-3540	18-0829	18-3609	1
C40	1991-97	18-3625	—	—	1
C40	1998-03	18-3540	18-0829	18-3609	1
P40	1998	18-3540	18-0829	18-3609	1
50	1984-85	—	18-0829	—	1
50	1986-09	18-3540	18-0829	18-3609	1
C50	1998-01	18-3540	18-0829	18-3609	1
PRO 50	1987-90	18-3540	18-0829	18-3609	1
P50	1991-96	18-3540	18-0829	18-3609	1
50 Jet	1986-00	18-3540	18-0829	18-3609	1
C55	1991-95	18-3625	—	—	1
CV55	1989-90	18-3625	—	—	1
60	2001-05	Kit Only	18-0835	18-3622	1
C60	1996-01	Kit Only	18-0835	18-3622	1
E60	1995-00	Kit Only	18-0835	18-3622	1
P60	1991-99	Kit Only	18-0835	18-3622	1

APPLICATION CONTINUED ON NEXT PAGE

YAMAHA 2-STROKE THERMOSTAT APPLICATION

HP/Model	Year	Thermostat	Gasket	Thermostat Kit	Qty. Per Engine
70	1984-09	Kit Only	18-0835	18-3622	1
C70	2000-01	Kit Only	18-0835	18-3622	1
C75	1994-99	—	18-0844	—	1
E75	1995-00	—	18-0844	—	1
P75	1996-99	—	18-0844	—	1
C80	1997	—	18-0844	—	1
90	1984-09	—	18-0844	—	1
90 Jet	1986-00	—	18-0844	—	1
B90	1997-99	—	18-0844	—	1
C90	1997-01	—	18-0844	—	1
115	1984-09	18-3540	18-0844	18-3608	2
B115	1998-99	18-3540	18-0844	18-3608	2
C115	1991-00	18-3540	18-0844	18-3608	2
P115	1993-96	18-3540	18-0844	18-3608	2
S115	1996-99	18-3540	18-0844	18-3608	2
130	1988-04	18-3540	18-0844	18-3608	2
L130	1989-01	18-3540	18-0844	18-3608	2
S130	1996-99	18-3540	18-0844	18-3608	2
C150	1996-99	18-3540	18-0844	18-3608	2
150	1984	—	18-0844	—	2
150	1985	18-3623	18-0844	—	2
150	1986-09	18-3540	18-0844	18-3608	2
D150	1997-99	18-3540	18-0844	18-3608	2
DX150	1999-05	18-3540	18-0844	18-3608	2
L150	1986-99	18-3540	18-0844	18-3608	2
LX150	1999-01	18-3540	18-0844	18-3608	2
LZ150	2000-05	18-3540	18-0844	18-3608	2
Z150	2000-05	18-3540	18-0844	18-3608	2
P150	1991-99	18-3540	18-0844	18-3608	2
PX150	1999	18-3540	18-0844	18-3608	2
PRO V150	1986-90	18-3540	18-0844	18-3608	2
S150	1996-99	18-3540	18-0844	18-3608	2
SX150	1999-04	18-3540	18-0844	18-3608	2
V150	2000-08	18-3540	18-0844	18-3608	2
VX150	2000-04	18-3540	18-0844	18-3608	2
VZ150	2000-11	18-3540	18-0844	18-3608	2
175	1984	—	18-0844	—	2
175	1985	18-3623	18-0844	—	2
175	1986-00	18-3540	18-0844	18-3608	2
P175	1994-99	18-3540	18-0844	18-3608	2
S175	1996-99	18-3540	18-0844	18-3608	2
V175	2000	18-3540	18-0844	18-3608	2
VZ175	2001-10	18-3540	18-0844	18-3608	2
Z175	2001-05	18-3540	18-0844	18-3608	2
200	1984	—	18-0844	—	2
200	1985	18-3623	18-0844	—	2
200	1986-98	18-3540	18-0844	18-3608	2
L200	1986-99	18-3540	18-0844	18-3608	2
LX200	1999-01	18-3540	18-0844	18-3608	2
LZ200	2000-11	18-3540	18-0844	18-3608	2
P200	1991-99	18-3540	18-0844	18-3608	2
SX200	1999-05	18-3540	18-0844	18-3608	2
V200	1998-99	18-3540	18-0829	18-3609	2
VX200	2000-05	18-3540	18-0829	18-3609	2
VZ200	2001-04	18-3540	18-0844	18-3608	2

APPLICATION CONTINUED ON NEXT PAGE

YAMAHA 2-STROKE THERMOSTAT APPLICATION

HP/Model	Year	Thermostat	Gasket	Thermostat Kit	Qty. Per Engine
VZ200	2005-09	18-3525	-	-	2
Z200	2000-11	18-3540	18-0844	18-3608	2
V6 Special	1985-86	18-3540	18-0844	18-3608	2
V6 Excel	1987-89	18-3540	18-0844	18-3608	2
225	1990-97	18-3540	18-0844	18-3608	2
L225	1994-99	18-3540	18-0829	18-3609	2
S225	1996-99	18-3540	18-0829	18-3609	2
LX225	2000-03	18-3540	18-0829	18-3609	2
SX225	2000-03	18-3540	18-0829	18-3609	2
V225	1998-99	18-3540	18-0829	18-3609	2
V225	2003-09	18-3525	-	-	2
VX225	2000-04	18-3540	18-0829	18-3609	2
VZ250	2003-09	18-3525	-	-	2
250	1990-95	18-3540	18-0829	18-3609	2
L250	1990-99	18-3540	18-0829	18-3609	2
LX250	2000-03	18-3540	18-0829	18-3609	2
S250	1996-99	18-3540	18-0829	18-3609	2
SX250	2000-03	18-3540	18-0829	18-3609	2
VX250	2002-04	18-3540	18-0829	18-3609	2
Z250 / LZ250	2003-05	18-3525	-	-	2
VZ300	2004-09	18-3525	-	-	2
Z300 / LZ300	2004-06	18-3525	-	-	2

YAMAHA 4-STROKE THERMOSTAT APPLICATION

HP/Model	Year	Thermostat	Gasket	Thermostat Kit	Qty. Per Engine
F2.5	2003-17	Kit Only	18-0754	18-3624	1
F4	1999-17	18-3541	18-0754	—	1
F6	2001-08	18-3541	18-99120	—	1
F6	2009-17	18-3541	18-0754	—	1
F8	2001-10	18-3541	18-99120	—	1
F8A	2011-14	18-3541	18-99120	—	1
F8B	2015-18	18-3541	18-99120	—	1
T8	2001-10	18-3541	18-99120	—	1
F9.9	1985-05	18-3541	18-99120	—	1
F9.9 (66N)	2005-06	18-3541	18-0835	18-3611	1
F9.9A	2011-12	18-3541	18-99120	—	1
F9.9B	2013-18	18-3541	18-99120	—	1
F9.9F	2007-10	18-3541	18-99120	—	1
FT9.9	1985-90	18-3541	18-99120	—	1
T9.9	1991-05	18-3541	18-99120	—	1
T9.9 (66R)	2005-06	18-3541	18-0835	18-3611	1
T9.9A	2011-12	18-3541	18-99120	—	1
T9.9B	2013-18	18-3541	18-99120	—	1
T9.9G	2007-10	18-3541	18-99120	—	1
F15	1998-06	18-3541	18-0835	18-3611	1
F25	1998-05	18-3541	18-0835	18-3611	1
F25A	2009-18	18-3541	18-0835	18-3611	1
F25B	2012-18	18-3541	18-0835	18-3611	1
F25	1998-08	18-3541	18-0835	18-3611	1
T25	2001-04	18-3541	18-0835	18-3611	1
T25	2001-08	18-3541	18-0835	18-3611	1
T25	2009-18	18-3541	18-0835	18-3611	1
F30	2001-05	18-3541	18-0835	18-3611	1
F30	2013-18	18-3541	18-0835	18-3611	1
F40	1999-06	18-3541	18-0835	18-3611	1

APPLICATION CONTINUED ON NEXT PAGE

YAMAHA 4-STROKE THERMOSTAT APPLICATION

HP/Model	Year	Thermostat	Gasket	Thermostat Kit	Qty. Per Engine
F40A	2008-18	18-3541	18-0835	18-3611	1
F40B	2007-08	18-3541	18-0835	18-3611	1
F50	1995-18	18-3541	18-0835	18-3611	1
T50	1996-18	18-3541	18-0835	18-3611	1
F60	2002-18	18-3541	18-0835	18-3611	1
T60	2003-18	18-3541	18-0835	18-3611	1
F70A	2010-18	18-3541	18-0835	18-3611	1
F75A	2003-17	18-3632	—	—	1
F75B	2017-18	18-3641	—	—	1
F80	1999-00	18-3541	—	—	1
F80	2001-03	18-3632	—	—	1
F90	2003-11	18-3632	—	—	1
F90A	2012-17	18-3632	—	—	1
F90B	2016-18	18-3641	—	—	1
VF90A	2018	18-3641	—	—	1
F100	1999-00	18-3541	—	—	1
F100	2001-03	18-3632	—	—	1
F115 / LF115	2000-14	18-3525	—	—	1
F115 / LF115	2014-18	18-3639	—	—	1
VF115	2015-18	18-3639	—	—	1
F150 / LF150	2004-11	18-3632	18-99127	—	1
F150A / LF150A	2012-14	18-3632	18-99127	—	1
F150B / LF150B	2015-18	18-3632	18-99127	—	1
F150C / LF150C	2017	18-3636	—	—	1
VF150	2013-17	18-3636	—	—	1
VF150A	2018	18-3636	—	—	1
F175A	2014-18	18-3636	—	—	1
F175C / LF175C	2017	18-3636	—	—	1
VF175	2015-18	18-3636	—	—	1
F200 / LF200	2005-10	18-3632	—	—	2
F200A / LF200A	2011-17	18-3632	—	—	2
F200B / LF200B	2012-18	18-3636	—	—	1
F200C / LF200C	2013-18	18-3636	—	—	1
VF200	2009-10	18-3632	—	—	2
VF200LA	2011-18	18-3637	—	—	2
F225 / LF225	2005-10	18-3632	—	—	2
F225A / LF225A	2011-17	18-3632	—	—	2
F225A / LF225A	2010-17	18-3524	—	—	2
F225B / LF225B	2016-17	18-3524	—	—	2
F225B / LF225B	2008-09	18-3632	—	—	2
VF225	2009-10	18-3632	—	—	2
VF225LA	2011-18	18-3637	—	—	2
F250 / LF250	2005-11	18-3632	—	—	2
F250A / LF250A	2010-17	18-3524	—	—	2
F250B / LF250B	2016-17	18-3524	—	—	2
VF250	2010	18-3632	—	—	2
VF250LA	2011-18	18-3637	—	—	2
VF250XA	2015-17	18-3524	—	—	2
F300 / LF300	2007-09	18-3634	—	—	2
F300A / LF300A	2010-18	18-3524	—	—	2
F350 / LF350	2007-09	18-3634	—	—	2
F350A / LF350A	2010-11	18-3634	—	—	2
F350B / LF350B	2012-15	18-3634	—	—	2
F350C / LF350C	2016-18	18-3634	—	—	2

**ALL PISTONS
ARE SUPPLIED WITH PISTON RINGS, WRIST PIN AND CIRCLIPS**



Piston Rings are available individually.

V-4 & V-6 Pistons and Rings

STANDARD			.25mm O.S.			.50mm O.S.		
18-4128 (Port) Replaces: 6G5-11642-00-93			18-4129 (Stbd.) Replaces: 6G5-11631-00-93			18-4130 (Port)		
— CONTAINS —						18-4132 (Port) Replaces: 6G5-11646-01-00		
18-4133 (Stbd.) Replaces: 6G5-11636-01-00								
Part #	Rings	O.E. #						
18-3934	Standard	6E5-11610-03-00						

V-6 Loop Charged Engines (1992-2001)

18-4080 (Port) Replaces: 6R5-11642-11-93			18-4081 (Stbd.) Replaces: 6R5-11631-11-93			18-4082 (Port) Replaces: 6R5-11645-11-00		
— CONTAINS —						18-4083 (Stbd.) Replaces: 6R5-11635-11-00		
18-4084 (Port) Replaces: 6R5-11646-11-00						18-4085 (Stbd.) Replaces: 6R5-11636-11-00		
Part #	Rings	O.E. #						
18-39320	Standard	6R5-11603-00						

★ ★ ★ Inline Pistons and Rings ★ ★ ★

STANDARD			.25mm O.S.			.50mm O.S.		
18-4091 Replaces: 6H3-11631-01-96 — CONTAINS —			18-3977 25mm O.S. O.E. # 682-11610-11-00			18-4093 Replaces: 6H3-11636-01-00		
Part #	Rings	O.E. #				18-4096 Replaces: 6K5-11636-03-00		
18-3963	Standard	6K5-11601-02-00				18-4146 Replaces: 61N-11636-00-00		
18-4135 Replaces: 6E7-11631-00-97 — CONTAINS —			18-4142 Replaces: 6H4-11635-01-00			18-4143 Replaces: 6H4-11636-00-00 — CONTAINS —		
Part #	Rings	O.E. #	18-4145 Replaces: 61N-11635-00-00 — CONTAINS —			18-4143 Replaces: 6H4-11636-00-00 — CONTAINS —		
18-3976	Standard	682-11610-01-00	Part #			Part #		
18-4138 Replaces: 689-11631-00-95 — CONTAINS —			18-3958			25mm O.S.		
Part #	Rings	O.E. #	61N-11604-00-00			50mm O.S.		
18-3954	Standard	689-11610-01-00				6H4-11610-20-00		
18-4141 Replaces: 6H4-11631-00-96 — CONTAINS —						18-4099 Replaces: 6H1-11636-03-00		
Part #	Rings	O.E. #						
18-3960	Standard	6H4-11610-00-00						
18-4097 Replaces: 6H1-11631-03-95 — CONTAINS —								
Part #	Rings	O.E. #						
18-3969	Standard	688-11603-A0-00						

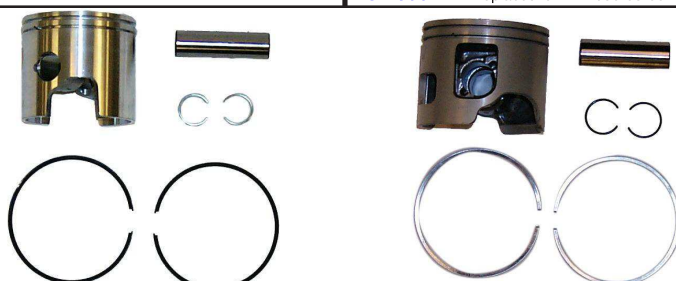

PISTON APPLICATION





HP/Model	Years	PISTON			RINGS		
		Std.	.25mm	.50mm	Std.	.25mm	.50mm
9,9/15	1984-96	18-4135	—	18-4137	18-3976	18-3977	—
9,9/15	1997-2009	18-4135	—	18-4137	18-3976	18-3977	—
25	1985	18-4138	—	—	18-3954	—	—
30	1984-86	18-4138	—	—	18-3954	—	—
C30	1991-92	18-4138	—	—	18-3954	—	—
C30	1993-97	—	18-4145	18-4146	18-3957	—	—
40	1984-88	18-4141	—	18-4143	18-3960	18-3961	18-3962
C40	1997-99,2001-02	—	18-4142	18-4143	18-3960	18-3961	18-3962
P40	1998	—	—	18-4143	18-3960	18-3961	18-3962
E48	1997	18-4097	—	18-4099	18-3969	—	—
50	1984-88	18-4141	—	18-4143	18-3960	18-3961	18-3962
50	1996-97, 1999, 2000,2002-03	18-4141	18-4142	18-4143	18-3960	18-3961	18-3962
C50	1998-99, 2001	—	18-4142	18-4143	18-3960	18-3961	18-3962
P50	1996	—	18-4142	18-4143	18-3960	18-3961	18-3962
Pro50	1987-88	18-4141	—	18-4143	18-3960	—	—
60	2001-05	18-4091	—	18-4093	18-3963	—	—
C60	1996-01	18-4091	—	18-4093	18-3963	—	—
E60 MLH,T,U,V	1995-00	—	—	18-4096	18-3963	—	—
P60	1991-99	18-4091	—	18-4093	18-3963	—	—
70	1984-09	18-4091	—	18-4093	18-3963	—	—
C70	2000-01	18-4091	—	18-4093	18-3963	—	—
75	1994-98	18-4097	—	18-4099	18-3969	—	—
C75	1996	18-4097	—	18-4099	18-3969	—	—







APPLICATION CONTINUED ON NEXT PAGE



PISTON APPLICATION (Cont.)

HP/Model	Years	PISTON			RINGS		
		Std.	.25mm	.50mm	Std.	.25mm	.50mm
C75	1998-99	18-4097	—	18-4099	18-3969	—	—
E75	1996-97	18-4097	—	18-4099	18-3969	—	—
P75	1996-99	18-4097	—	18-4099	18-3969	—	—
C80	1997	18-4097	—	18-4099	18-3969	—	—
C85	1996	18-4097	—	18-4099	18-3969	—	—
90	1994-09	18-4097	—	18-4099	18-3969	—	—
C90	1997-01	18-4097	—	18-4099	18-3969	—	—

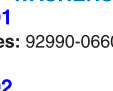
V4 & V-6 Engines	Years	PISTON						RINGS	
		Port Std.	Stbd. Std.	Port .25mm	Stbd. .25mm	Port .50mm	Stbd. .50mm	Std.	Std.
115 w/22mm wrist pin	V-4 1984-86	18-4128	18-4129	18-4130	—	18-4132	18-4133	18-3934	18-3936
115 w/22mm wrist pin	V-4 1987-92	18-4128	18-4129	18-4130	—	18-4132	18-4133	18-3934	18-3936
115 w/23mm wrist pin	V-4 1993-03	18-4080	18-4081	18-4082	18-4083	18-4084	18-4085	18-39320	18-3936
130 w/22mm wrist pin	V-4 1984-92	18-4128	18-4129	18-4130	—	18-4132	18-4133	18-3934	18-3936
130 w/23mm wrist pin	V-4 1993-03	18-4080	18-4081	18-4082	18-4083	18-4084	18-4085	18-39320	18-3936
150, 175 w/22mm wrist pin	V-6 1984-92	18-4128	18-4129	18-4130	—	18-4132	18-4133	18-3934	18-3936
150, 175 w/23mm wrist pin	V-6 1993-99	18-4080	18-4081	18-4082	18-4083	18-4084	18-4085	18-39320	18-3936
200, 225 w/22mm wrist pin	V-6 1984-92	18-4128	18-4129	18-4130	—	18-4132	18-4133	18-3934	18-3936
200, 225 w/22mm wrist pin	V-6 1993-99	18-4080	18-4081	18-4082	18-4083	18-4084	18-4085	18-39320	18-3936
SPECIAL J,K,LN,XN (6G7)	V-6 1984-86	18-4128	18-4129	18-4130	—	18-4132	18-4133	18-3934	18-3936

 <p>18-1755 CONNECTING ROD Replaces: 650-11651-04-00 Fits: 9.9, 15 (1996-97)</p>	 <p>18-1756 CONNECTING ROD Replaces: 688-11650-03-00 Fits: 55 (1991-95), 75 (1994-99), 80 (1997), 85 (1991-96), 90 (1997, 2000-01)</p>	 <p>18-1755K CONNECTING ROD KIT Replaces: 650-11651-04-00 Fits: E336 9.9 (1996-97), 15 (1996-97)</p>	 <p>18-4157 CONNECTING ROD Replaces: 6R5-11650-10-00 For: V6 150/175/200 (1992-03)</p>	 <p>18-1410 ROD BEARING Replaces: 93310-32337-00 Fits: 115 (1993-03), 130 (1993-00, 2002-03), 150 (1992-00, 2002-03), 175 (1992-98, 2000), 200 (1992-98), 225 (1992-93, 1997)</p>
---	--	--	---	---

 <p>18-1411 ROD BEARING Replaces: 93310-620V5-00 Fits: 9.9 (1996-97), 15 (1996-97)</p>	 <p>18-4077 ROD BEARING Replaces: 93310-730V8-00 For: 45, 55, 90 HP -3 Cyl.</p>	 <p>18-4078 ROD BEARING Replaces: 93310-836V2-00 For: V4 & V6 (1990 motors)</p>	 <p>18-0191 WASHERS Replaces: 92990-06600-00</p>	 <p>18-0192 Replaces: 92990-10600-00, 929-90106-00-00, 92900-10600-00, 92901-10600-00, 92902-10600-00, 92903-10600-00, 92995-10600-00</p>	 <p>18-79974 OIL STRAINER Replaces: 6J8-13411-00 Fits: 20(1996-97), 25(1988-01), 30(1987-02), 40(1989-05), 50(1989-09), 60(2001-05), 70(1989-09), C30(1995), P40(1989), P50(1991-96), P60(1991-99), PRO50(1989-90)</p>
--	---	---	---	--	--

 <p>18-79975 OIL STRAINER Replaces: 6E5-13411-00 Fits: 115(1988-09), 130(1988-05), 150(1989-09), 175(1989-00), 200(1989-98), 225(1990-97), B115(1998-99), D150(1997-99(01), DX150(1999-05), L130(1989-01), L150(1988-99), L200(1988-99), LX150(1999-01), LX200(1999-01), LZ150(2000-05), LZ200(1999-12), P115(1993-96), P150(1991-99), P175(1994-99), P200(1991-99), PRO V150(1988-90), PX150(1999), S115-(1996-99), S130(1996-99), S150(1996-99), S200(1996-99)SX150(1999-04), SX200(1999-05), V150(2000-08), V175(2000), V6 Excel(1988-89), VX150(2000-04), VZ150(2000-12), VZ175(2001-12), VZ200(2001-04), Z150(2000-05), Z175(2001-05), Z200(2000-12)</p>	 <p>18-79976 OIL STRAINER Replaces: 61A-13411-00 Fits: 225(1994-95), 250(1990-95), L225(1994-99), L250(1990-99), LX225(2000-03), LX250(2000-03), LZ250(2003-05), LZ300(2004-06), S225(1996-99), S250(1996-99), SX225(2000-03), SX250(2000-03), V200(1998-99), V225(1998-99), VX200(2000-05), VX225(2000-04), VX250(2002-04), VZ200(2005-09), VZ225(2003-09), VZ250(2003-09), VZ300(2004-09), Z250(2003-05), Z300(2004-06)</p>
---	--

 <p>18-79971 OIL STRAINER, ELECTRIC Replaces: 68F-13440-00 Fits: LZ150(2000-05), LZ200(2000-12), LZ250(2003-05), LZ300(2004-06), VZ150(2000-12), VZ175(2001-12), VZ175(2001-12), VZ200(2001-09), VZ225(2003-09), VZ250(2003-09), VZ300(2004-09), Z150(2000-05), Z175(2001-05), Z200(2000-12), Z250(2003-05), Z300(2004-06)</p>	 <p>18-79961 OIL STRAINER Replaces: 6H1-13411-00 Fits: 90(1990-01), B90(1997-99), C90(2000-01), P75(1996-99)</p>	 <p>18-7911-1 OIL FILTER Replaces: 5GH-13440-00, 5GH-13440-10, 5GH-13440-30</p>	 <p>18-7954 OIL FILTER Replaces: N26-13440-02-00, N26-13440-00-00 Fits: F350</p>
--	--	--	--



**18-8700
OIL FILTER**

Replaces: 5GH-13440-50-00, 5GH-13440-20, 5JW-13400-00-00, 2MB-E3440-00-00, 1WD-E3440-00-00
Fits: F15(2006-12), F20(2006-12), F25(2009-12), F40(2008-12), F50(2005-12), F60(2005-12), F70(2010-12), T25(2009-12), T50(2005-12), T60(2005-12)



4-CYCLE OUTBOARD OIL FILTERS

Make-Model	Years	Replaces	Part No.
F/T9.9	1990-03	6G8-13440-00-00	18-7901
F/T50	1995-99	3FV-13440-20-00, 3FV-13440-00-00	18-7902
F15,F25	1998-99	3FV-13440-20-00, 3FV-13440-00-00	18-7902
F80/F100	1999	3FV-13440-20-00, 3FV-13440-00-00	18-7902
F40	1999-00	3FV-13440-20-00, 3FV-13440-00-00	18-7902
F200/F225	2002-06	69J-13440-00-00, -01-00, -03-00	18-7906-1
F150	2004-06	69J-13440-00-00, -01-00, -03-00	18-7906-1
F250	2005-06	69J-13440-00-00, -01-00, -03-00	18-7906-1
F350	2008-up	N26-13440-02-00, N26-13440-00-00	18-7954



**18-9390
OIL CHANGE KIT**

Replaces: LUB-MRNSM-KT-10
Fits: F30(2001-06), F40(1999-08), F40A(2009 & Up), F50(1995 & Up), T50(1996 & Up), F60(2002 & Up), T60(2003 & Up), F70(2010 & Up)



**18-9391
OIL CHANGE KIT**

Replaces: LUB-MRNMD-KT-10
Fits: F75(2003 & Up), F80(1999-02), F90(2003 & Up), F100(1999-02), F115(2000 & Up)



**18-9392
OIL CHANGE KIT**

Replaces: LUB-MRNMD-KT-10
Fits: F150(2004 & Up)



**18-9393
OIL CHANGE KIT**

Replaces: LUB-MRNLG-KT-10
Fits: F200 3.3L(2002 & Up), F225 3.3L(2002 & Up), F225 Sport(2008), F250A 3.3L(2005 & Up), F250B 3.3L(2005 & Up)

TIMING BELTS



FEATURES:

- Neoprene or Nitrile construction for maximum durability based on application
- Positive Slip Proof engagement
- Fiberglass tension member for excellent flex and elongation behavior
- Chemical and Contaminant Resistance for Long Life
- Meets or Exceeds OEM belt specifications
- Modified Curvilinear or Trapezoidal tooth profile for direct OE fitment/replacement
- Recommended periodic maintenance interval of 5 years or 1000 hours of use
(Note: Timing belt should be inspected every 100 hours and replaced as necessary.)
- Inexpensive insurance to prevent catastrophic engine failure

Sierra Timing Belts provide extended durability and smoother performance characteristics required by today's marine engines.

Part No.	Replaces	Fits
18-15130	6C5-46241-00-00	Fits: F25 (2009-2017), T25 2009-2017, F30 (2013-2017), F40 (2008-2017), F50 (2005-2017), T50 (2005-2010), F60 (2005-2017), T60 (2005-2017), F70 (2010-2017)
18-15131	67F-46241-00-00	Fits: F75 (2003-2011), F80 (1999-2003), F90 (2005-2015), F100 (1999-2003), F115 (2000-2014), LF115 (2000-2014)
18-15132	6P2-46241-02-00	Fits: F200 (2011-2017), LF200 (2011-2017), F225 (2007-2017), F250 (2005-2017), LF250 (2005-2017)
18-15133	6G8-46241-00-00	Fits: F9.9 (1985-2005), FT9.9 (1985-1990), T9.9 (1991-2005)
18-15134	6CB-W4624-00-00	Fits: F225 (2010-2017), LF225 (2010-2017), F250 (2010-2017), FL250 (2010), LF250 (2010-2017), F300 (2010-2017), FL300 (2010), LF300 (2010-2017), VF200 (2009-2017), VF225 (2009-2017), VF250 (2009-2017)
18-15135	65W-46241-00-00	Fits: F25 (1998-2005), T25 (2001-2005), F30 (2001-2005), F40 (2000-2008)
18-15136	6AH-46241-00-00	Fits: F15 (2006-2017), F20 (2006-2017)
18-15137	66M-46241-00-00	Fits: F9.9 (2005-2006), F15 (1998-2005)
18-15138	68T-46241-00-00	Fits: F6 (2001-2008), T8 (2001-2010), F8 (2001-2017), F9.9 (2007-2017), T9.9 (2007-2017)
18-15139 <small>NEW</small>	6AW-W4624-00-00	F300/LF300 (5.3L) (2007-09), F350/LF350 (5.3L) (2007-09), F350A/LF350A (5.3L) (2010-11), F350/LF350 (5.3L) (2012-15), F350C/LF350C (2016-18)
18-15140 <small>NEW</small>	63P-46241-00-00	F150/LF150 (2004-11), F150/LF150 (2012-14), F150B/LF150B (2015-18)
18-15141 <small>NEW</small>	69J-46241-00-00	F200/LF200 (2002-10), F225/LF225 (2002-10)
18-15142 <small>NEW</small>	6DA-W4624-00-00	F150C/LF150C (2017-18), VF150 (2013-17), VF150A (2018)
18-15143 <small>NEW</small>	60V-46241-00-00	VZ200 (2005-09), VZ225 (2005-09), VZ250 (2005-09), Z250/LZ250 (2003-05), VZ300 (2005-09), Z300/LZ300 (2004-06)
18-15144 <small>NEW</small>	62Y-46241-00-00	F40 (1999), F50 (1995-03), T50 (1996-04), F60 (2002-04), T60 (2003-04)
18-15145 <small>NEW</small>	68F-46241-10-00	VZ150 (2004-14), Z150/LZ150 (2004-05)

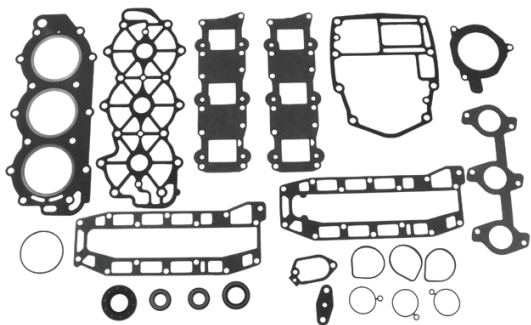

18-99061
GASKET SET

Replaces: 63D-W0001-00
Fits: 40(1995-05), 50(1995-069), C40(1997-02), C50(1998-01), P40(1998), P50(1995-96)



18-99073
GASKET SET

Replaces: 65W-W0001-20
Fits: F25(1998-00)

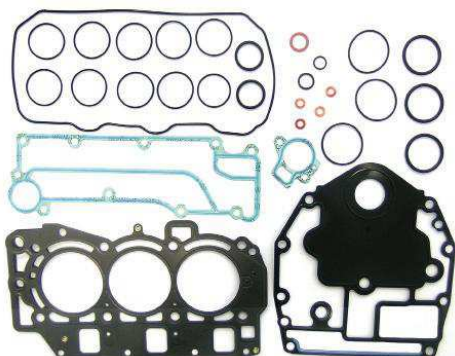

18-99092
GASKET SET

Replaces: 67C-W0001-00
Fits: F30(2001), F40(2000-01)



18-99093
GASKET SET

Replaces: 67C-W0001-20
Fits: F30(2001), F40(2000-01), T25(2001)

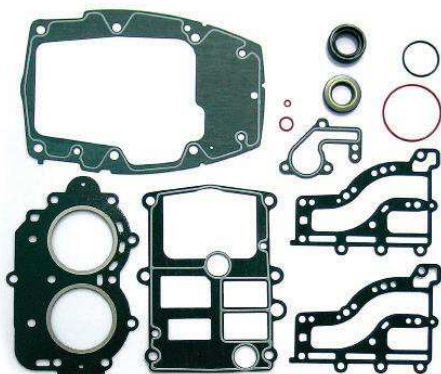

18-99097
GASKET SET

Replaces: 682-W0001-06
Fits: 9.9(1994-95), 15(1994-95)



18-99103
GASKET SET

Replaces: 68F-W0001-01
Fits: LZ150(2004-05), LZ200(2004-10), VZ150(2004-10), VZ175(2004-10), VZ200(2004), Z150(2004-05), Z175(2004-05), Z200(2004-10)

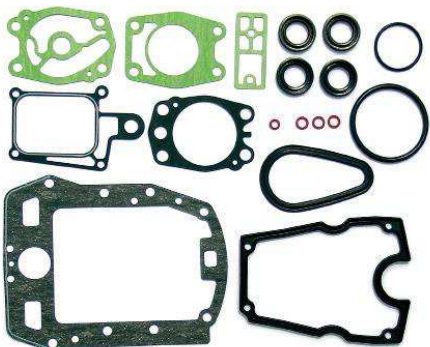

18-99104
GASKET SET

Replaces: 6A0-W0001-21
Fits: C40(1992-94)

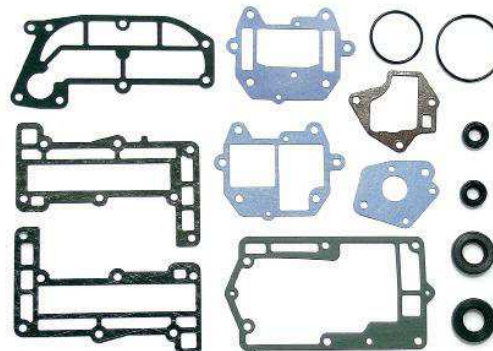

18-99117
GASKET SET

Replaces: 6G1-W0001-A2
Fits: 6(1996), 8(1996)

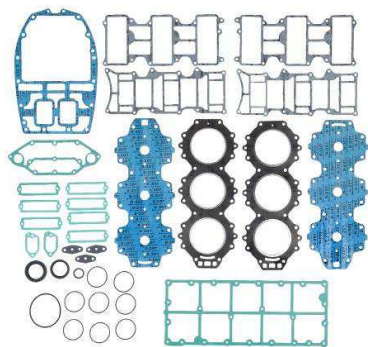

**18-4400
POWERHEAD GASKET SET**

Replaces: 61A-W0001-01-00, 61A-W0001-A1-00
— CONTAINS—

Part #	Desc.	O.E. #	Qty.
18-3891	Head Gasket	61A-11181-00-A0	2
18-0829	O-Ring	61A-12414-A0-00, 6J8-12414-A0-00	2
18-0808	Pressure Control Valve Gasket	6G5-11382-A1-00	1

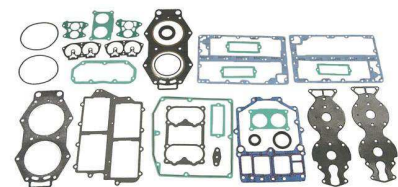

**18-4403
POWERHEAD GASKET SET**

Replaces: 6F3-W0001-04-00, 6F3-W0001-A4-00
— CONTAINS—

Part #	Desc.	O.E. #	Qty.
18-3832	Head Gasket	6E5-11181-02-00	2
18-0844	Thermostat Cover Gasket	688-12414-A1-00	2
18-2079	Oil Seal	93101-22M15-00	1
18-2085	Oil Seal	93102-35M13-00	1
18-7442	O-Ring	93210-74M35-00	1
18-7444	O-Ring	93211-04384-00	2
18-0782	Cover Gasket	6E5-11381-A1-00	1
18-0799	Exhaust Cover Gasket	6E5-41112-A1-00	2
18-0823	Exhaust Manifold Gasket	6E5-13645-A1-00	1
18-0785	Carb Mounting Gasket	6E5-14198-A1-00	2
18-0813	Powerhead Base Gasket	6G5-45113-A0-00	1
18-2592	Float Bowl Gasket	6E5-14384-03-00	2
18-0781	Water Jacket Gasket	6E5-11193-A0-00	2

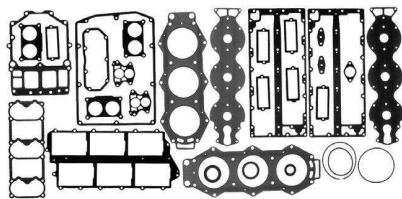

**18-4404
POWERHEAD GASKET SET**

Replaces: 6G5-W0001-03-00, 6G5-W0001-A3-00
— CONTAINS—

Part #	Desc.	O.E. #	Qty.
18-3894	Head Gasket	6G5-11181-A0-00	2
18-0844	Thermostat Cover Gasket	688-12414-A1-00	2
18-2079	Oil Seal	93101-22M15-00	1
18-2085	Oil Seal	93102-35M13-00	1
18-7442	O-Ring	93210-74M35-00	1
18-7444	O-Ring	93211-04384-00	2
18-0785	Carb Mounting Gasket	6E5-14198-A1-00	3
18-0808	Pressure Control Valve Gasket	6G5-11382-A1-00	1
18-0813	Powerhead Base Gasket	6G5-45113-A0-00	1
18-0782	Cover Gasket	6E5-11381-A1-00	1
18-0809	Reed Block Gasket	6G5-13645-A1-00	1
18-0812	Exhaust Cover Gasket	6G5-41112-A1-00	2
18-0779	Water Jacket Gasket	6G5-11193-A0-00	2

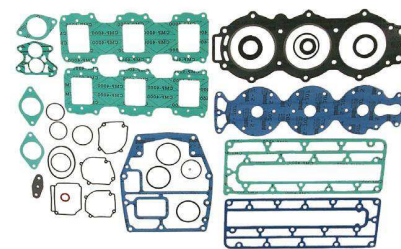

**18-4405
POWERHEAD GASKET SET**

Replaces: 6H1-W0001-00-00, 6H1-W0001-01-00, 6H1-W0001-A0-00
— CONTAINS—

Part #	Desc.	O.E. #	Qty.
18-3805	Head Gasket	688-11181-02-00	1
18-0840-1	O-Ring	676-14984-00-00	3
18-0844	Thermostat Cover Gasket	688-12414-A1-00	1
18-0847	Exhaust Cover Gasket	688-41112-A0-00	1
18-0826	Drain Screw Gasket	90430-14115-00	1
18-7436	O-Ring	93210-46044-00	3
18-0767	Water Jacket Cover Gasket	688-11193-01-00	1

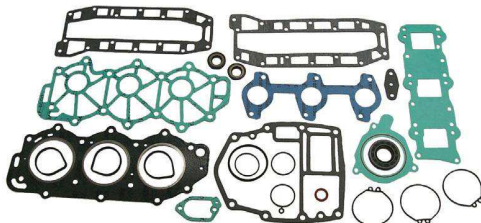

**18-4407
POWERHEAD GASKET SET**

Replaces: 6H4-W0001-01-00, 6H4-W0001-A1-00
— CONTAINS—

Part #	Desc.	O.E. #	Qty.
18-3830	Head Gasket	6H4-11181-00-00	1
18-0826	Drain Screw Gasket	90430-14115-00	1
18-0815	Water Jacket Gasket	6H4-11193-A1-00	1
18-0798	Exhaust Cover Gasket	6H4-41114-A0-00	1
18-0829	Cover Gasket	61A-12414-A0-00, 6J8-12414-A0-00	1

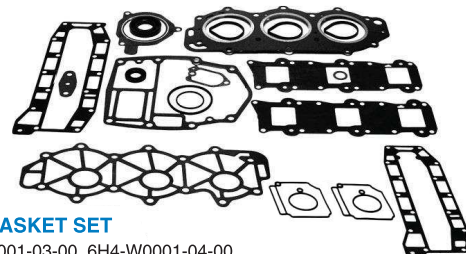

**18-4409
POWERHEAD GASKET SET**

Replaces: 6H4-W0001-03-00, 6H4-W0001-04-00
— CONTAINS—

Part #	Desc.	O.E. #	Qty.
18-3830	Head Gasket	6H4-11181-00-00	1
18-0826	Drain Screw Gasket	90430-14115-00	1
18-7432	O-Ring	93210-32768-00	1
18-0815	Water Jacket Gasket	6H4-11193-A1-00	1
18-0798	Exhaust Cover Gasket	6H4-41114-A0-00	1
18-0829	Cover Gasket	61A-12414-A0-00, 6J8-12414-A0-00	1

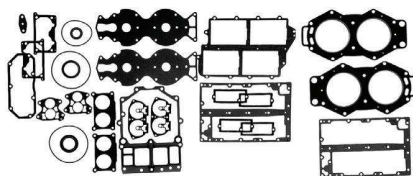

**18-4411
POWERHEAD GASKET SET**

Replaces: 6N6-W0001-03-00, 6N6-W0001-A3-00
— CONTAINS—

Part #	Desc.	O.E. #	Qty.
18-3832	Head Gasket	6E5-11181-02-00	2
18-0844	Thermostat Cover Gasket	688-12414-A1-00	2
18-2079	Oil Seal	93101-22M18-00	1
18-2085	Oil Seal	93102-35M13-00	1
18-7442	O-Ring	93210-74M35-00	1
18-7444	O-Ring	93211-04384-00	2
18-0782	Cover Gasket	6E5-11381-A1-00	1
18-0799	Exhaust Cover Gasket	6E5-41112-A1-00	2
18-0823	Exhaust Manifold Gasket	6E5-13645-A1-00	1
18-0785	Carb Mounting Gasket	6E5-14198-A1-00	2
18-0813	Powerhead Base Gasket	6G5-45113-A0-00	1
18-2592	Float Bowl Gasket	6E5-14384-03-00	2
18-0781	Water Jacket Gasket	6E5-11193-A0-00	2

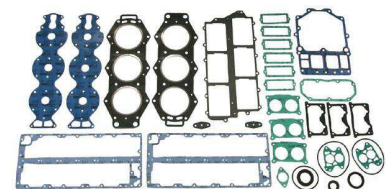

**18-4412
POWERHEAD GASKET SET**

Replaces: 6R3-W0001-03-00, 6R3-W0001-A3-00
— CONTAINS—

Part #	Desc.	O.E. #	Qty.
18-3894	Head Gasket	6G5-11181-A0-00	2
18-0844	Thermostat Cover Gasket	688-12414-A1-00	2
18-2079	Oil Seal	93101-22M18-00	1
18-2085	Oil Seal	93102-35M13-00	1
18-7442	O-Ring	93210-74M35-00	1
18-7444	O-Ring	93211-04384-00	2
18-0782	Cover Gasket	6E5-11381-A1-00	1
18-0809	Reed Block Gasket	6G5-13645-A1-00	1
18-0812	Exhaust Cover Gasket	6G5-41112-A1-00	2
18-0779	Water Jacket Gasket	6G5-11193-A0-00	2
18-0785	Carb Mounting Gasket	6E5-14198-A1-00	3
18-0808	Pressure Control Valve Gasket	6G5-11382-A1-00	1
18-0816	Powerhead Base Gasket	6G5-45113-A0-00	1

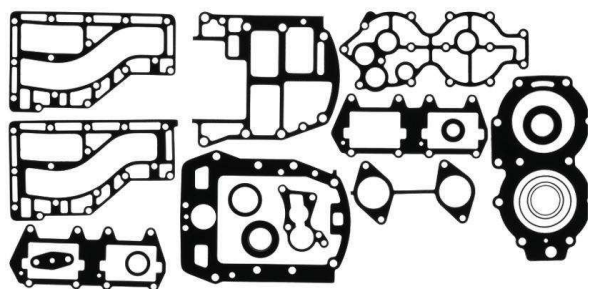

**18-4413
POWERHEAD GASKET SET**

Replaces: 6R6-W0001-01-00

— CONTAINS —

Part #	Desc.	O.E. #	Qty.
18-3892	Head Gasket	676-11181-00-A0	1
18-7126	O-Ring	—	1

**18-4415
POWERHEAD GASKET SET**

Replaces: 688-W0001-00-00, 688-W0001-A0-00

— CONTAINS —

18-0840	Fuel Bowl Seal	676-14984-00-00	3
18-3805	Head Gasket	688-11181-02-00	1
18-0844	Thermostat Cover Gasket	688-12414-A1-00	1
18-0846	Carburetor Mounting Gasket	688-14198-A1-00	3
18-0847	Exhaust Cover Gasket	688-41112-A0-00	2
18-0826	Drain Screw Gasket	90430-14115-00-00	1
18-0767	Water Jacket Cover Gasket	688-11193-01-00	1
18-0845	Intake Manifold Reed Plate Gasket	688-13621-A1-00	2
18-7441	O-Ring	93210-62269-00	1

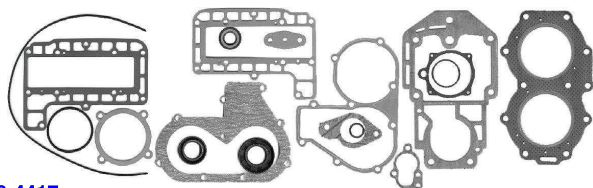

**18-4417
POWERHEAD GASKET SET**

Replaces: 695-W0001-01-00, 695-W0001-02-00, 695-W0001-A2-00

— CONTAINS —

Part #	Desc.	O.E. #	Qty.
18-0231	Packing Gasket	648-13621-A1-00	1
18-0771	Intake Manifold Gasket	648-13645-A0-00	1
18-0775	Carburetor Mounting Gasket	648-14198-A0-00	1
NSS	Bowl Gasket	648-14384-01-00	1
18-0232	Cover Gasket	655-12414-A1-00	1
18-0250	Exhaust Cover Gasket	664-41114-A0-00	2
18-2078	Oil Seal	93101-16M36-00	1
18-0570	Oil Seal	93102-23096-00	1
18-3849	Head Gasket	695-11181-A0-00	1
18-0739	Upper Casing Gasket	689-45113-A1-00	1

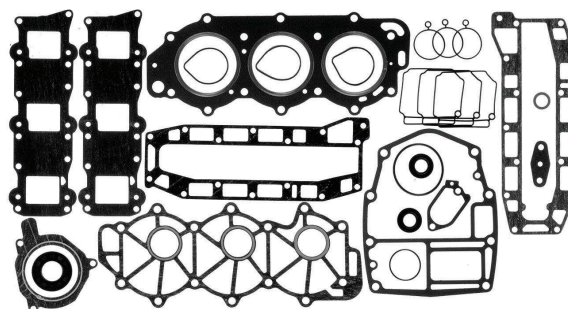

**18-4419
POWERHEAD GASKET SET**

Replaces: 6H4-W0001-02-00, 6H4-W0001-A2-00

— CONTAINS —

Part #	Desc.	O.E. #	Qty.
18-3830	Head Gasket	6H4-11181-00-00	1
18-0826	Drain Screw Gasket	90430-14115-00-00	1

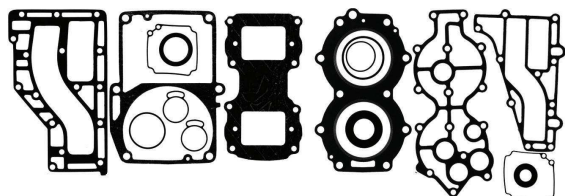

**18-4422
POWERHEAD GASKET SET**

Replaces: 6L2-W0001-01-00, 6L2-W0001-02-00, 6L2-W0001-A2-00

— CONTAINS —

Part #	Desc.	O.E. #	Qty.
18-3847	Head Gasket	6L2-11181-A1-00	1
18-0765	Flat Chamber Gasket	6L2-14384-00-00	1
18-0743	Exhaust Inner Cover Gasket	6L2-41112-A1-00	1
18-0744	Exhaust Outer Cover Gasket	6L2-41114-A1-00	1
18-0748	Upper Casing Gasket	6L2-45113-A1-00	1



**18-99175
POWERHEAD GASKET SET**

Replaces: 63V-W0001-00, 63V-W0001-01

Fits: 9.9(1996-00), 15(1996-00)

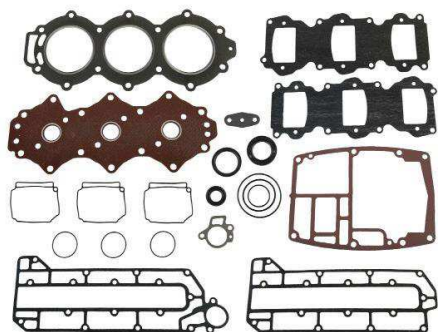

**18-99176
POWERHEAD GASKET SET**





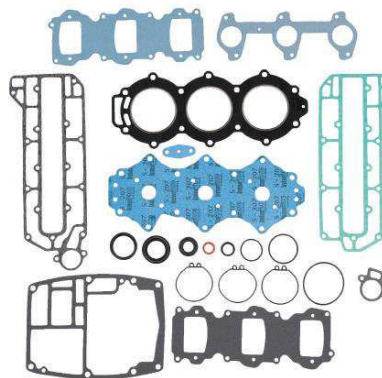

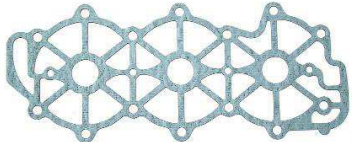
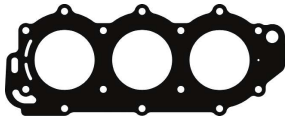

Replaces: 6H3-W0001-02

Fits: 60(2001-05), 70(1994-09), C70(2000-01), P60(1994-99)



**18-4427
POWERHEAD GASKET SET**

Replaces: 6H3-W0001-A0-00

 <p>18-0663 PLENUM GASKET KIT Fits: Yamaha F75 (2003-04), F80 (1999-03), F90 (2003-04), F100 (1999-02)</p>	 <p>18-99048 HEAD GASKET Replaces: 60V-11181-00 Fits: LZ250(2003-05), VZ200(2005-09), VZ225(2003-09), VZ250(2003-09), Z250(2003-05)</p>	 <p>18-99059 HEAD GASKET Replaces: 63D-11193-A0 Fits: 40(1995-05), 50(1995-09), C40(1997-03), C50(1998-01), P40(1998), P50(1995-96)</p>	
 <p>18-99060 HEAD GASKET Replaces: 63D-11181-A1 Fits: 40(1997-05), 50(1997-08), C40(1997-03), C50(1998-01), P40(1998)</p>	 <p>18-99062 HEAD GASKET Replaces: 68F-11181-00 Fits: LZ150(2000-05), LZ200(2000-10), VZ150(2000-10), VZ175(2001-10), VZ200(2001-04), Z150(2000-05), Z175(2001-05), Z200(2000-10)</p>	 <p>18-99094 HEAD GASKET Replaces: 67F-11181-02 Fits: F75(2004-05), F90(2004-05), F115(2004-05), LF115(2004-05)</p>	 <p>18-3804 HEAD GASKET Replaces: 689-11181-02-00, 689-W0001-A1-00</p>
 <p>18-3805 HEAD GASKET Replaces: 688-11181-02-00, 688-11181-A1-00</p>	 <p>18-3827 HEAD GASKET Replaces: 6G8-11181-00-00, 6G8-11181-A1-00</p>	 <p>18-3828 HEAD GASKET Replaces: 6E7-11181-00-00, 6E7-11181-A1-00</p>	 <p>18-3829 HEAD GASKET Replaces: 6J8-11181-00-00, 6J8-11181-A1-001</p>
 <p>18-3830 HEAD GASKET Replaces: 6H4-11181-00-00, 6H4-11181-A1-00</p>	 <p>18-3831 HEAD GASKET Replaces: 6H3-11181-01-00, 6H3-11181-A1-00</p>	 <p>18-3832 HEAD GASKET Replaces: 6E5-11181-02-00, 6E5-11181-A1-00</p>	
 <p>18-3847 HEAD GASKET Replaces: 6L2-11181-A1-00, 6L2-11181-A2-00</p>	 <p>18-3848 HEAD GASKET Replaces: 697-11181-A0-00, 697-11181-A1-00</p>	 <p>18-3849 HEAD GASKET Replaces: 695-11181-A0-00, 695-11181-A1-00</p>	
 <p>18-3891 HEAD GASKET Replaces: 61A-11181-A0-00, 61A-11181-A1-00</p>	 <p>18-3892 HEAD GASKET Replaces: 676-11181-A0-00, 676-11181-A1-00</p>	 <p>18-3894 HEAD GASKET Replaces: 6G5-11181-00-00, 6G5-11181-A0-00</p>	

SEE PAGES 201-202 FOR OUR COMPLETE LINE OF GASKET SEALANTS
APPLICATION BEGINS ON NEXT PAGE

POWERHEAD GASKET SETS / HEAD GASKETS APPLICATION

HP	Year	Powerhead Gasket Set	Head Gasket	HP	Year	Powerhead Gasket Set	Head Gasket
6	1988-96	18-99117		F80	1999-01		18-99094
8	1984-96	18-99117		F80	2002-03		18-99094
9.9	1984-87		18-3828	C85	1991	18-4415	18-3805
9.9	1988-91		18-3828	C85	1992-93		18-3805
9.9	1992-93		18-3828	C85	1994-96		18-3805
9.9	1994-95		18-3828	CV85	1989-90	18-4415	18-3805
9.9	1996	18-99175		90	1984-93	18-4405	18-3805
9.9	1997-00	18-99175	18-99140	90	1994-09		18-3805
9.9	2001-08		18-99140	B90	1997-99		18-3805
F9.9	1986-89		18-3827	C90	1997-01		18-3805
F9.9	1990-05		18-3827	F90	2003-04		18-99094
FT9.9	1985-87		18-3827	F90	2005-11		18-99094
FT9.9	1988-89		18-3827	F100	1999-01		18-99094
FT9.9	1990		18-3827	F100	2002-03		18-99094
T9.9	1991-05		18-3827	115	1984		18-3832
15	1984-87		18-3828	115	1985		18-3832
15	1988-91		18-3828	115	1986	1	18-3832
15	1992-93		18-3828	115	1986-89	2	18-3832
15	1994-95	18-99097		115	1990-99		18-3832
15	1996	18-99175		115	2000-01		18-3832
15	1997-00	18-99175	18-99140	115	2002-09		18-3832
15	2001-08		18-99140	B115	1998-99		18-3832
20	1996-97		18-3847	C115	1991-95	18-4403	18-3832
25 (2 cyl)	1984-87		18-3804	C115	1996-99		18-3832
25 (2 cyl)	1988-93	18-4422	18-3847	C115	2000		18-3832
25 (2 cyl)	1994-09		18-3847	F115	2000-01		18-99094
25 (3 cyl)	1997-02		18-3829	F115	2002-05		18-99094
C25	1991-93	18-4417	18-3849	F115	2006-11		18-99094
C25	1994-97		18-3849	LF115	2000-01		18-99094
CV25	1990	18-4417	18-3849	LF115	2002-05		18-99094
F25	1998-01	18-99073		LF115	2006-11		18-99094
30	1984-86		18-3804	P115	1993-96	18-4411	18-3832
30	1987-94		18-3829	S115	1996-99	18-4411	18-3832
30	1993-02		18-3829	130	1988-99	18-4403	18-3832
C30	1991-92		18-3804	130	2000-01		18-3832
C30	1995-97		18-3829	130	2002-04		18-3832
CV30	1989-90		18-3804	L130	1989	18-4403	18-3832
F30	2000	18-99093		L130	1990-99	18-4411	18-3832
F30	2001-05	18-99092		L130	2000-01		18-3832
40	1984-88	18-4407	18-3830	S130	1996-99	18-4411	18-3832
40	1989-91	18-4419	18-3830	150	1984-89	18-4404	18-3894
40	1992-94	18-4409	18-3830	150	1990-95	18-4412	18-3894
40	1995-05	18-99061	18-99060	150	1996-03		18-3894
C40 2 Cyl	1991		18-3892	150	2004-09		18-3894
C40 2 Cyl	1992-93	18-4413	18-3892	C150	1996-99	18-4404	18-3894
C40 2 Cyl	1994-97	18-4414	18-3892	D150	1997-99		18-3894
C40 3 Cyl	1998-03	18-99061	18-99060	DX150	1999-03		18-3894
CV40	1990		18-3892	DX150	2004-05		18-3894
F40	2000-08	18-99092		L150	1986-89	18-4404	18-3894
P40	1998	18-99061	18-99060	L150	1990-95	18-4412	18-3894
50	1984-88	18-4407	18-3830	L150	1996-99		18-3894
50	1989-91	18-4419	18-3830	LX150	1999-01		18-3894
50	1992-94	18-4419	18-3830	LZ150	2000-03		18-99062
50	1995-09	18-99061	18-99060	LZ150	2004-05	18-99103	18-99062
C50	1998-01	18-99061	18-99060	Z150	2000-03		18-99062
PRO 50	1987-88	18-4407	18-3830	Z150	2004-05	18-99103	18-99062
PRO 50	1989-90	18-4419	18-3830	P150	1991-93	18-4412	18-3894
P50	1991	18-4419	18-3830	P150	1994-95		18-3894
P50	1992-94	18-4409	18-3830	P150	1996-99		18-3894
P50	1995-96	18-99061	18-99060	PX150	1999		18-3894
C55	1991		18-3848	PRO V150	1987-89	18-4404	18-3894
C55	1992-93		18-3848	PRO V150	1990	18-4412	18-3894
C55	1994-95		18-3848	S150	1996-99		18-3894
CV55	1989-90		18-3848	SX150	1999-03		18-3894
60	2001-05	18-99176	18-3831	SX150	2004		18-3894
C60	1996-01		18-3831	V150	2000-03		18-3894
E60	1995-00		18-3831	V150	2004-08		18-3894
P60	1991	18-4427	18-3831	VX150	2000-03		18-3894
P60	1992-93		18-3831	VX150	2004		18-3894
P60	1994-99	18-99176	18-3831	VZ150	2000-03		18-99062
70	1984-91	18-4427	18-3831	VZ150	2004-11	18-99103	18-99062
70	1992-93		18-3831	175	1984-89	18-4404	18-3894
70	1994-09	18-99176	18-3831	175	1990-95	18-4412	18-3894
C70	2000-01	18-99176	18-3831	175	2000		18-3894
C75	1994-96		18-3805	P175	1996-99		18-3894
C75	1998-99		18-3805	S175	1996-99		18-3894
E75	1995-00		18-3805	V175	2000		18-3894
F75	2003-04		18-99094	VZ175	2001-02		18-99062
F75	2005, 2007-11		18-99094	VZ175	2003-11	18-99103	18-99062
F75	2006		18-99094	Z175	2001-03		18-99062
P75	1996-99		18-3805	Z175	2004-05	18-99103	18-99062
C80	1997		18-3805	200	1984-89	18-4404	18-3894

① LJ:-357803/XJ:-700843

③ 2.6 litre engine



② LJ: 357804/XJ: 700844

④ 3.1 litre engine

HP	Year	Powerhead Gasket Set	Head Gasket	HP	Year	Powerhead Gasket Set	Head Gasket
200	1990-95	18-4412	18-3894	L225 ④	1994-96	18-4400	18-3891
200	1996-98		18-3894	L225	1997-99		18-3891
L200	1986-89	18-4404	18-3894	S225	1996	18-4400	18-3891
L200	1990-95	18-4412	18-3894	S225	1997-99		18-3891
L200	1996-99		18-3894	LX225	2000-03		18-3891
LX200	1999-01		18-3894	SX225	2000-03		18-3891
LZ200	2000-03		18-99062	V225	1998-99		18-3891
LZ200	2004-11	18-99103	18-99062	VX225	2000-04		18-3891
P200	1991-95		18-3894	VZ225	2003-04		18-99048
P200	1996-99		18-3894	VZ225	2005-09		18-99048
S200	1996-99		18-3894	250	1990-95	18-4400	18-3891
SX200	1999-03		18-3894	L250	1990-96	18-4400	18-3891
SX200	2004-05		18-3894	L250	1997-99		18-3891
V200	1998-99		18-3891	LX250	2000-03		18-3891
VX200	2000-05		18-3891	LZ250	2003-04		18-99048
VZ200	2000-03		18-99062	LZ250	2005		18-99048
VZ200	2004-09	18-99103	18-99062	S250	1996	18-4400	18-3891
Z200	2000-03		18-99062	S250	1997-99		18-3891
Z200	2004-11	18-99103	18-99062	SX250	2000-03		18-3891
V6 Special	1984-86	18-4404	18-3894	VZ250	2003-04		18-99048
V6 Excel	1987-89		18-3894	VZ250	2005-09		18-99048
225 ③	1990-95		18-3894	Z250	2003-04		18-99048
225	1996-97		18-3894	Z250	2005		18-99048
225 ④	1994-95	18-4400	18-3891				

① LJ:-357803/XJ:-700843
 ② LJ: 357804/XJ: 700844

③ 2.6 litre engine
 ④ 3.1 litre engine

 <p>18-0406 WATER PUMP GASKET Replaces: 60X-43315-A0-00 Fits: VZ200 (3.3L) 2005-10, VZ225 (3.3L) 2003-10, VZ250 (3.3L) 2003-10, VZ300 (3.3L) 2005-10</p>	 <p>18-0605 EXHAUST MANIFOLD SEAL Replaces: 67F-41138-00-00 Fits: F75 2003-Current; F80 1999-2003; F90 2003-Current; F100 1999-2003; F115 2000-Current.</p>	 <p>18-0617 EXHAUST SEAL Replaces: 67F-45127-00-00 Fits: F75 2003-Current; F80 1999-2003; F90 2003-Current; F100 1999-2003; F115 2000-Current.</p>	 <p>18-0618 EXHAUST MANIFOLD GASKET Replaces: 68V-45123-00-00</p>
 <p>18-0619 EXHAUST TUBE SEAL Replaces: 69J-41138-00-00</p>	 <p>18-0656 EXHAUST TUBE SEAL Replaces: 69J-45123-00-00</p>	 <p>18-0755 CRANKCASE DRAIN GASKET Replaces: 90430-14M09-00, 904-30142-28-00, 90430-14228-00 Fits: Four-Stroke 9.9hp.- 300hp. / 1999 - Current</p>	 <p>18-0849 FUEL PUMP MOUNTING GASKET Replaces: 650-24431-A0-00</p>
 <p>18-0856-1 GASKET Replaces: 64D-14384-01-00</p>	 <p>18-99000 EXHAUST MANIFOLD GASKET Replaces: 61A-41134-A0 Fits: 225(1994-95), 250(1992-95), L225 (1994-99), L250(1992-99), LX225(2000-03), LX250(2000-03), LZ250(2003-05), LZ300 (2004-05), S225(1996-99), S250(1996-99), SX225(2000-03), SX250(2000-03), V200(1998-99), V225(1998-99), VX200(2000-05), VX250 (2000-04), VZ200(2005), VZ225(2003-05), VZ250(2003-05), VZ300(2004-05), Z250(2003-05), Z300(2004-05)</p>	 <p>18-99001 UPPER CASING GASKET Replaces: 61A-45114-A0 Fits: 225(1994-95), 250(1992-95), L225 (1994-99), L250(1992-99), LX225(2000-03), LX250(2000-03), S225(1996-99), S250 (1996-99), SX225(2000-03), SX250 (2000-03), V200(1998-99), V225(1998-99), VX200(2000-05), VX225(2000-04), VX250(2002-04)</p>	 <p>18-99002 EXHAUST MANIFOLD GASKET Replaces: 62Y-41133-00 Fits: F25(1998-00), F40(1999), F50(1995-00), T50(1996-00)</p>
 <p>18-99003 EXHAUST GASKET Replaces: 62Y-41134-01 Fits: F30(2002-05), F40(2002-08), F50(2002-04), F60(2002-04), T25(2002-05), T50(2002-04)</p>	 <p>18-99004 UPPER CASING GASKET Replaces: 63D-45114-A0 Fits: 40(1995-05), 50(1995-09), C40(1997-03), C50(1998-01), P40(1998), P50(1995-96)</p>	 <p>18-99005 MUFFLER GASKET Replaces: 63D-45123-00 Fits: 40(1995-05), 50(1995-09), C40(1997-03), C50(1998-01), P40(1998), P50(1995-96)</p>	 <p>18-99006 EXHAUST MANIFOLD GASKET Replaces: 63V-41133-A1 Fits: 9.9(1997-09), 15(1997-09)</p>

SEE PAGES 201-202 FOR OUR COMPLETE LINE OF GASKET SEALANTS



18-99008
EXHAUST
MANIFOLD GASKET

Replaces: 64J-41133-10
Fits: F40(2008-10), F60(2002-04), T25(2009-10), T60(2003-04)



18-99009
MUFFLER GASKET

Replaces: 663-45123-00
Fits: (1985-94), (1984-94), C55(1991-95), CV55(1989-90), E48(1995-00), F40(1999), F50(1995-04), P50(1991-94), PR50(1989), PRO 50(1987-90), T50(1996-04)

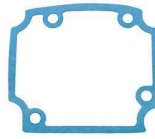

18-99010
EXHAUST
MANIFOLD GASKET

Replaces: 664-41134-A0
Fits: C25(1992-97), C30(1992-97)



18-99012
EXHAUST
MANIFOLD GASKET

Replaces: 66M-41133-00
Fits: F15(1998-04)

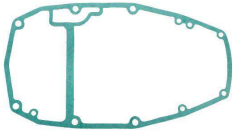

18-99013
UPPER
CASING GASKET

Replaces: 66M-45113-00
Fits: F9.9(2005-06), F15(1998-05), T9.9(2005-06)

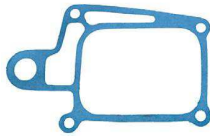

18-99014
EXHAUST
MANIFOLD GASKET

Replaces: 676-41133-A0
Fits: C40(1992-97)

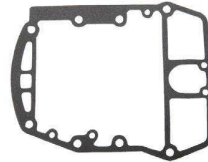

18-99015
UPPER
CASING GASKET

Replaces: 676-45114-A0
Fits: C40(1991-97), CV40(1990)



18-99016
EXHAUST
MANIFOLD GASKET

Replaces: 67C-41133-00
Fits: F25(2001-05, 2009-10), F30(2001-05), F40(2000-08), F50(2001-04), T25(2005-06)



18-99017
MUFFLER GASKET

Replaces: 67C-45123-00
Fits: F30(2001-05), F40(2000-10), F60(2002-04), T25(2001-06, 2009-10), T60(2003-04)



18-99018
EXHAUST
MANIFOLD GASKET

Replaces: 67F-41133-A1
Fits: F75(2003-10), F90(2004-10), F115(2004-10), LF115(2004-10)

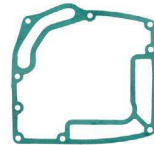

18-99019
EXHAUST
MANIFOLD GASKET

Replaces: 67F-41134-A0
Fits: F75(2003-10), F80(1999-03), F90(2003-10), F100(1999-03), F115(2000-10), LF115(2000-10)



18-99020
MUFFLER GASKET

Replaces: 67F-45123-00
Fits: F75(2003-10), F80(1999-03), F90(2003-10), F100(1999-03)



18-99021
EXHAUST
MANIFOLD GASKET

Replaces: 682-41133-A0
Fits: 9.9(1992-95), 15(1992-95)



18-99022
UPPER
CASING GASKET

Replaces: 682-45113-A1
Fits: 9.9(1984-95), 15(1984-95)



18-99023
EXHAUST
MANIFOLD GASKET

Replaces: 688-41133-00
Fits: 90(1984-09), B90(1997-99), C75(1994-96, 98-99), C80(1997), C85(1991-96), C90(1997-01), CV85(1989-90), E75(1995-00), P75(1996-99)

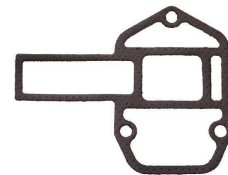

18-99024
EXHAUST
MANIFOLD GASKET

Replaces: 688-41134-A0
Fits: 90(1984-09), B90(1997-99), C75(1994-99), C80(1997), C85(1991-96), C90(1997-01), CV85(1989-90), E75(1995-00), P75(1996-99)

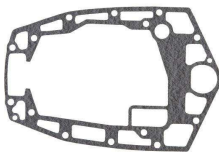

18-99025
UPPER
CASING GASKET

Replaces: 688-45114-A1
Fits: 90(1984-09), B90(1997-99), C75(1994-99), C80(1997), C85(1991-96), C90(1997-01), CV85(1989-90), E75(1995-00), P75(1996-99)



18-99026
MUFFLER GASKET

Replaces: 688-45123-00
Fits: 90(1984-09), B90(1997-99), C75(1994-99), C80(1997), C85(1991-96), C90(1997-01), CV85(1989-90), E75(1995-00), P75(1996-99)

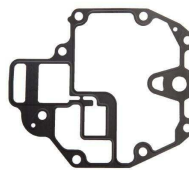





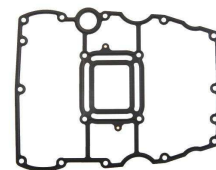





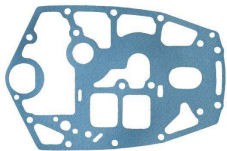
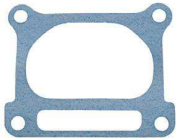
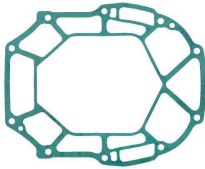
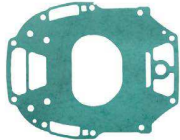



18-99027
OIL PAN GASKET

Replaces: 68T-13475-00
Fits: F6(2001-08), F8(2001-10), F9.9(2007, 2010), T8(2001-10), T9.9(2007-10)

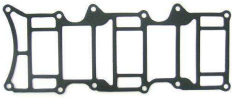
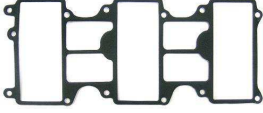
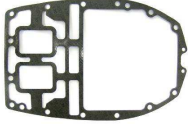

18-99028
OIL PAN GASKET

Replaces: 68V-15312-00
Fits: F75(2003-10), F90(2004-10), F115(2004-10), LF115(2004-10)

 <p>18-99030 UPPER CASING GASKET Replaces: 697-45114-A0 Fits: E48(1995-00), C55(1992-95)</p>	 <p>18-99032 EXHAUST MANIFOLD GASKET Replaces: 69J-41134-A0 Fits: F200(2002-05), F225(2002-05), LF200(2002-05), LF225(2002-05)</p>	 <p>18-99033 EXHAUST MANIFOLD GASKET Replaces: 69J-41135-A0 Fits: F200(2002-10), F225(2002-10), F250(2005-10), LF200(2002-10), LF225(2002-10), LF250(2005-10)</p>	 <p>18-99034 EXHAUST MANIFOLD GASKET Replaces: 69J-41136-A0 Fits: F200(2002-05), F225(2002-05), F250(2005), LF200(2002-05), LF225(2002-05), LF250(2005)</p>	
 <p>18-99037 EXHAUST MANIFOLD GASKET Replaces: 6E5-41134-A0 Fits: 115(1992-09), 130(1992-04), B115(1998-99), C115(1992-00), C115(1992-00), L130(1994-01), P115(1993-96), S115(1996-99), S130(1996-99)</p>	 <p>18-99038 EXHAUST MANIFOLD GASKET Replaces: 6E5-41135-A0 Fits: 115(1992-09), 130(1992-04), 150(1992-09), 175(1992-95), 2000, 200(1992-98), 225(1992-97), B115(1998-99), C115(1992-00), C150(1996-99), D150(1997-99), DX150(1999-05), L150(1992-01), L200(1992-99), LX150(1999-01), LX200(1999-01), LZ150(2000-05), LZ200(2000-10), P115(1993-96), P150(1992-99), P175(1994-99), P200(1992-99), PX150(1999), S115(1996-99), S130(1996-99), S150(1996-99), S175(1996-99), S200(1996-99), SX150(1999-04), SX200(1999-05), V150(2000-08), V175(2000), VX150(2000-04), VZ150(2000-10), VZ175(2001-10), VZ200(2001-04), Z150(2000-05), Z175(2001-05), Z200(2000-10)</p>	 <p>18-99039 EXHAUST MANIFOLD GASKET Replaces: 6G5-41134-A1 Fits: 115(2003-04), 130(2003-04), 150(2003-09), DX150(2003-05), LZ150(2003-05), LZ200(2003-10), SX150(2003-04), SX200(2003-05), V150(2003-08), VX150(2003-04), VZ150(2003-10), VZ175(2003-10), VZ200(2003-04), Z150(2003-05), Z175(2003-05), Z200(2003-10)</p>	 <p>18-99040 UPPER CASING GASKET Replaces: 6G5-45114-A1 Fits: 115(2003-09), 130(2003-04), 150(2003-09), DX150(2003-05), LZ150(2003-05), LZ200(2003-10), SX150(2003-04), SX200(2003-05), V150(2003-08), VX150(2003-04), VZ150(2003-10), VZ175(2003-10), VZ200(2003-04), Z150(2003-05), Z175(2003-05), Z200(2003-10)</p>	
 <p>18-99045 UPPER CASING GASKET Replaces: 6G8-45113-A1 Fits: F9.9(1997-05), T9.9(1995-05)</p>	 <p>18-99046 UPPER CASING GASKET Replaces: 6H3-45114-A1 Fits: 60(2002-05), 70(1984-069), C60(1996-01), C70(2001-02), E60(1995-00), P60(1991-99)</p>	 <p>18-99047 MUFFLER GASKET Replaces: 6H3-45123-00 Fits: 60(2001-05), 70(1984-09), C60(1996-01), C70(2000-01), E60(1995-00), P60(1991-99)</p>	 <p>18-99049 REED GASKET Replaces: 60V-13621-A0 Fits: LZ250(2003-05), LZ300(2004-06), VZ200(2005-09), VZ225(2003-09), VZ250(2003-09), VZ300(2004-09), Z250(2003-05), Z300(2004-06)</p>	 <p>18-99050 INTAKE GASKET Replaces: 60V-13645-00 Fits: LZ250(2003-05), LZ300(2004-06), VZ200(2005-09), VZ225(2003-09), VZ300(2004-09), Z250(2003-05), Z300(2004-06)</p>
 <p>18-99051 VALVE COVER GASKET Replaces: 61A-11193-A1 Fits: L225(1996-99), L250(1996-99), LX225(2000-03), LX250(2000-03), S225(1996-99), S250(1996-99), SX225(2000-03), SX250(2000-03), V200(1998-99), V225(1998-99), VX200(2000-05), VX225(2000-04)</p>	 <p>18-99052 SIDE COVER GASKET Replaces: 61A-11381-A0 Fits: 225(1994-95), 250(1992-95), L225(1994-99), L250(1992-99), LX225(2000-03), LX250(2000-03), S225(1996-99), S250(1996-99), SX225(2000-03), SX250(2000-03), V200(1998-99), V225(1998-99), VX200(2000-05), VX225(2000-04), VX250(2002-04)</p>	 <p>18-99053 INTAKE GASKET Replaces: 61A-13621-A0 Fits: 225(1994-95), 250(1992-95), DX150(1999-05), L225(1994-99), L250(1992-99), LX150(1999-01), LX200(1999-01), LX225(2000-03), LX250(2000-03), LZ150(2000-05), LZ200(2000-10), PX150(1999), S225(1996-99), S250(1996-99), SX150(1999-04), SX200(1999-05), SX225(2000-03), SX250(2000-03), V200(1998-99), V225(1998-99), VX150(2000-04), VX200(2000-05), VX225(2000-04), VX250(2002-04), VZ150(2000-10), VZ175(2001-10), VZ200(2001-04), Z150(2000-05), Z175(2001-05), Z200(2000-10)</p>	 <p>18-99054 INTAKE GASKET Replaces: 61A-13645-00 Fits: 225(1994-95), 250(1990-95), L225(1994-96), L250(1990-96), S225(1996), S250(1996)</p>	
 <p>18-99055 MANIFOLD GASKET Replaces: 61A-13646-00 Fits: 225(1994-95), 250(1990-95), L225(1994-96), L250(1990-96), S225(1996), S250(1996)</p>	 <p>18-99056 BASE GASKET Replaces: 61A-45113-A0 Fits: 225(1994-95), 250(1990-95), L225(1994-99), L250(1990-99), LX225(2000-03), LX250(2000-03), S225(1996-99), S250(1996-99), SX225(2000-03), SX250(2000-03), V200(1998-99), V225(1998-99), VX200(2000-05), VX225(2000-04), VX250(2002-04)</p>	 <p>18-99057 VALVE COVER GASKET Replaces: 61T-11193-A1 Fits: C30(1993-97)</p>	 <p>18-0242 VALVE SEAT GASKET Replaces: 663-13622-00-00, 663-13622-A0-00</p>	

SEE PAGES 201-202 FOR OUR COMPLETE LINE OF GASKET SEALANTS



18-99064
INTAKE GASKET

Replaces: 64E-13645-A0
Fits: 150(1996-99), 200(1996-98), 225(1996-97), D150(1997-99), L150(1996-99), L200(1996-99), P150(1996-99), P175(1996-99), P200(1996-99), S150(1996-99), S175(1996-99), V150(2000-08), V175(2000)



18-99066
INTAKE GASKET

Replaces: 65L-13645-00
Fits: DX150(1999-05), L225(1997-99), L250(1997-99), LX150(1999-01), LX200(1999-01), LX225(2000-03), LX250(2000-03), LZ150(2000-05), LZ200(2000-10), PX150(1999), S225(1997-99), S250(1997-99), SX150(1999-04), SX200(1999-05), SX200(2000-03), SX225(2000-03), SX250(2000-03), V200(1998-99), V225(1998-99), VX150(2000-04), VX200(2000-05), VX225(2000-04), VX250(2002-04), VZ150(2000-10), VZ175(2001-10), VZ200(2001-04), Z150(2000-05), Z175(2001-05), Z200(2000-10)

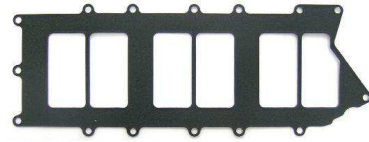

18-99067
INTAKE GASKET

Replaces: 65L-13646-00
Fits: DX150(1999-05), L225(1997-99), L250(1997-99), LX150(1999-01), LX200(1999-01), LX225(2000-03), LX250(2000-03), LZ150(2000-05), LZ200(2000-10), PX150(1999), S225(1997-99), S250(1997-99), SX150(1999-04), SX200(1999-05), SX200(2000-03), SX225(2000-03), SX250(2000-03), V200(1998-99), V225(1998-99), VX150(2000-04), VX200(2000-05), VX225(2000-04), VX250(2002-04), VZ150(2000-10), VZ175(2001-10), VZ200(2001-04), Z150(2000-05), Z175(2001-05), Z200(2000-10)



18-99063
LOWER CASING GASKET

Replaces: 63V-45315-A0
Fits: 9.9(1996-09), 15(1996-09), F9.9(2005-06), F15(1998-05), T9.9(2005-06)

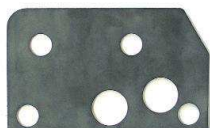

18-99068
BREATHER COVER GASKET

Replaces: 65W-11169-00
Fits: F25(1998-01), T25(2001)



18-99069
BASE GASKET

Replaces: 65W-11351-00
Fits: F25(1998-02), T25(2001-02)

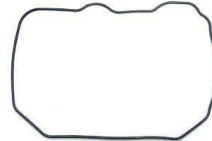

18-99070
CRANKCASE GASKET

Replaces: 65W-11356-00
Fits: F25(1998-05), T25(2001-06)



18-99071
GASKET

Replaces: 65W-14457-10
Fits: F25(1999-05), T25(2001-06)



18-99072
EXHAUST GASKET

Replaces: 65W-41114-00
Fits: F25(1998-05), T25(2001-06)



18-99074
BASE GASKET

Replaces: 66M-11351-10
Fits: F9.9(2005-06), F15(2005), T9.9(2005-06)



18-99075
CYLINDER COVER GASKET

Replaces: 66M-11356-00
Fits: F9.9(2005-06), F15(1998-05), T9.9(2005-06)



18-99076
WATER PUMP GASKET

Replaces: 66M-13329-10
Fits: F9.9(2005-06), F15(2001-05), T9.9(2005-06)



18-99078
GASKET

Replaces: 66M-41138-00
Fits: F15(1998-04)



18-99079
UPPER CASING GASKET

Replaces: 66M-45115-00
Fits: F9.9(2005-06), F15(1998-05), T9.9(2005-06)



18-99080
INTAKE GASKET

Replaces: 676-13646-A0
Fits: C40(1991-97), CV40(1990)

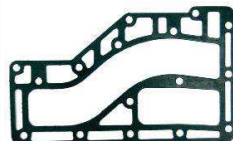

18-99081
EXHAUST GASKET

Replaces: 676-41112-A0
Fits: C40(1991-97), CV40(1990)



18-99082
WATER PUMP GASKET

Replaces: 676-44315-A1
Fits: C40(1991-97), CV40(1990)



18-99083
WATER PUMP GASKET

Replaces: 676-44324-A0
Fits: C40(1991-97), CV40(1990)



18-99084
EXHAUST GASKET

Replaces: 676-45127-00
Fits: C40(1991-97), CV40(1990)



18-99085
EXHAUST GASKET

Replaces: 676-45128-00
Fits: C40(1991-97), CV40(1990)



18-99086
WATER PUMP GASKET

Replaces: 679-44316-A0
Fits: C40(1991-97), CV40(1990)

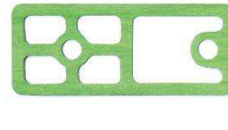













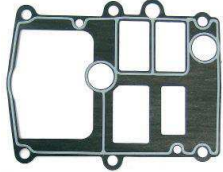
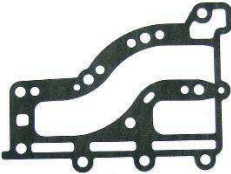



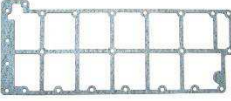
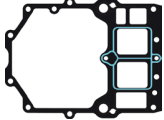
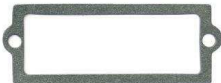

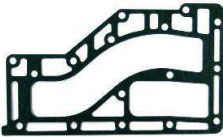
18-99087
LOWER CASING GASKET

Replaces: 679-45315-A0
Fits: C40(1991-94), CV40(1990)

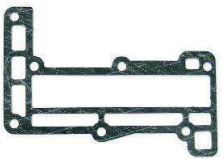
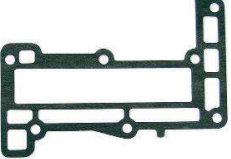

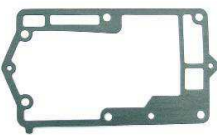
18-99088
CYLINDER COVER GASKET

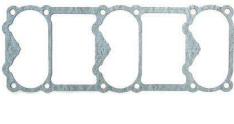
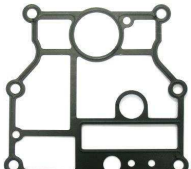
Replaces: 67C-11356-00
Fits: F30(2001-05), F40(2000-08)

 <p>18-99089 EXHAUST GASKET Replaces: 67C-41114-00 Fits: F30(2001), F40(2000-01)</p>	 <p>18-99091 GASKET Replaces: 67C-45113-00 Fits: F25(2001), F30(2001), F40(2000-01), t25(2001)</p>	 <p>18-99095 BASE GASKET Replaces: 682-11351-A0 Fits: 9.9(1984-95), 15(1984-95)</p>	 <p>18-99096 GASKET Replaces: 682-41112-A1 Fits: 9.9(1984-95), 15(1984-95)</p>	 <p>18-60508 THERMOSTAT GASKET Replaces: 60V-12414-A0-00 Fits: Yamaha LZ250(2003-05), LZ300(2004-06), VZ200(2005-09), VZ225(2003-09), VZ250(2003-09), VZ300(2004-09), Z250(2003-05), Z300(2004-06)</p>
 <p>18-99098 INTAKE GASKET Replaces: 688-13621-A1 Fits: 90(1992-09), B90(1997-99), C75(1994-99), C80(1997), C85(1992-96), C90(1997-01), E75(1995-00), P75(1996-99)</p>	 <p>18-99099 VALVE COVER GASKET Replaces: 68F-11193-01 Fits: LZ150(2000-05), LZ200(2000-08), VZ150(2000-08), VZ175(2001-08), VZ200(2001-04), Z150(2000-05), Z175(2001-05), Z200(2000-08)</p>	 <p>18-99100 GASKET Replaces: 68F-11381-00 Fits: LZ150(2000-05), LZ200(2000-10), VZ150(2000-10), VZ175(2001-10), VZ200(2001-04), Z150(2000-05), Z175(2001-05), Z200(2000-10)</p>	 <p>18-99101 EXHAUST GASKET Replaces: 68F-41114-00 Fits: LZ150(2000-05), LZ200(2000-10), VZ150(2000-10), VZ175(2001-10), VZ200(2001-04), Z150(2000-05), Z175(2001-05), Z200(2000-10)</p>	 <p>18-99102 BASE GASKET Replaces: 68F-45113-00 Fits: 150(2004-08), DX150(2004-05), LZ150(2000-05), LZ200(2000-08), SX150(2004), SX200(2004-05), V150(2004-08), VX150(2004), VZ150(2000-08), VZ175(2001-08), VZ200(2001-04), Z150(2000-05), Z175(2001-05), Z200(2000-08)</p>
 <p>18-99105 INTAKE GASKET Replaces: 6E5-13621-A1 Fits: 115(1992-09), 130(1992-04), 150(1992-09), 175(1992-95, 2000), 200(1992-98), B115(1998-969), C115(1992-00), C150(1996-99), L130(1992-01), L150(1992-99), L200(1992-98), P115(1993-96), P150(1993), S115(1996-99), S130(1996-99), S150(1996-99), S175(1996-99), S200(1996-99)</p>	 <p>18-99106 VALVE COVER GASKET Replaces: 6E9-11193-A0 Fits: C40(1991-97), CV40(1990)</p>	 <p>18-99107 EXHAUST GASKET Replaces: 6E9-41114-A0 Fits: C40(1992-97)</p>	 <p>18-99108 VALVE COVER GASKET Replaces: 6G1-11193-A1 Fits: 6(1986-00), 8(1984-09)</p>	 <p>18-99109 REED GASKET Replaces: 6G1-13621-A1 Fits: 6(1991-00), 8(1991-09)</p>
 <p>18-99110 INTAKE GASKET Replaces: 6G1-13645-A1 Fits: 6(1991-00), 8(1991-09)</p>	 <p>18-99111 INTAKE GASKET Replaces: 6G1-14198-A1 Fits: 6(1986-00), 8(1984-09)</p>	 <p>18-99112 EXHAUST GASKET Replaces: 6G1-41112-A1 Fits: 6(1986-00), 8(1984-09)</p>	 <p>18-99113 EXHAUST GASKET Replaces: 6G1-41114-A0 Fits: 6(1991-00), 8(1991-09)</p>	 <p>18-99114 EXHAUST GASKET Replaces: 6G1-41133-A0 Fits: 6(1992-00), 8(1992-09)</p>
 <p>18-99115 BASE GASKET Replaces: 6G1-45113-A1 Fits: 6(1986-00), 8(1984-09)</p>	 <p>18-99116 WATER PUMP GASKET Replaces: 6G1-45315-A0 Fits: 6(1986-00), 8(1984-09)</p>	 <p>18-99118 CARBURETOR GASKET Replaces: 6G5-14483-A1 Fits: C150(1996-99)</p>	 <p>18-99119 BASE GASKET Replaces: 6G8-11351-A0 Fits: F9.9(1985-05), FT9.9(1985-90), T9.9(1991-05)</p>	 <p>18-99120 THERMOSTAT GASKET Replaces: 6G8-12414-A0 Fits: F6(2001-04), F8(2001-04), F9.9(1985-05, 2007, 2010), FT9.9(1985-90), T8(2001-04), T9.9(1991-05, 2007-10)</p>

SEE PAGES 201-202 FOR OUR COMPLETE LINE OF GASKET SEALANTS



**18-99121
INTAKE GASKET**
Replaces: 6G8-13646-A0
Fits: F9.9(1985-05), FT9.9(1985-90), T9.9(1991-05)



**18-99122
INTAKE GASKET**
Replaces: 6G8-14198-A0
Fits: F9.9(1992-05), T9.9(1992-05)

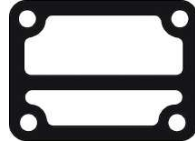

**18-99123
GASKET**
Replaces: 6G8-15374-00
Fits: F9.9(1985-05), FT9.9(1985-90), T9.9(1991-05)



**18-99124
THERMOSTAT GASKET**
Replaces: 6H3-12414-A1
Fits: 60(2001-05), 70(1984-09), C60(1996-01), C70(2000-01), E60(1995-00), P60(1991-99)

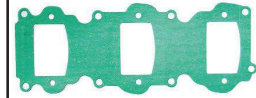

**18-99125
INTAKE GASKET**
Replaces: 6H3-13622-00
Fits: 70(1985-91), P60(1991)



**18-99126
INTAKE GASKET**
Replaces: 6H3-14198-01
Fits: 70(1984-91), P60(1991)

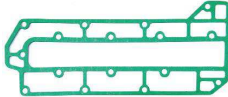

**18-99128
EXHAUST GASKET**
Replaces: 6H3-41114-A0
Fits: 60(2001-05), 70(1992-09), C60(1996-01), C70(2000-01), E60(1995-00), P60(1992-99)

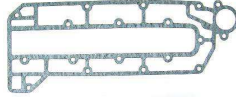

**18-99129
EXHAUST GASKET**
Replaces: 6H3-41112-A0
Fits: 60(2001-05), 70(1986-09), C60(1996-01), C70(2000-01), E60(1995-00), P60(1991-99)

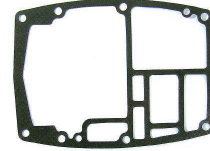

**18-99130
EXHAUST GASKET**
Replaces: 6H3-45113-A0
Fits: 60(2001-025), 70(1984-09), C60(1996-01), C70(2000-01), E60(1995-00), P60(1991-99)

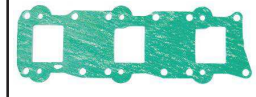

**18-99132
REED GASKET**
Replaces: 6H4-13621-A1
Fits: 40(1984-05), 50(1984-09), C40(1997-03), C50(1998-01), P40(1998), P50(1991-96), PR50(1989), Pro 50(1987-90)



**18-99133
GASKET**
Replaces: 6H4-14198-01
Fits: 40(1989-05), 50(1989-09), C40(1997-03), C50(1998-01), P40(1998), P50(1991-96), PR50(1989), Pro 50(1989-90)



**18-99134
END CAP GASKET**
Replaces: 6H4-15369-A1
Fits: 40(1984-01), 50(1984-09), C40(1997-03), C50(1998-01), P40(1998), P50(1991-96), PR50(1989), Pro 50(1987-90)

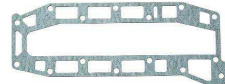

**18-99135
EXHAUST GASKET**
Replaces: 6H4-41112-A0
Fits: 40(1992-05), 50(1992-09), C40(1997-03), C50(1998-01), P40(1998), P50(1992-96)



**18-99136
INTAKE GASKET**
Replaces: 6K7-13646-A1
Fits: 225(1990-95), P150(1994-95), P175(1994-95), P200(1992-95), V6 Excel(1987-89)



**18-99137
EXHAUST GASKET**
Replaces: 6L2-41133-A2
Fits: 25(2004-08)



**18-99138
WATER PUMP GASKET**
Replaces: 6L2-45315-A0
Fits: 20(1996-97), 25(1992-09)



**18-99139
INTAKE GASKET**
Replaces: 6OV-13646-00
Fits: LZ250(2003-05), LZ300(2004-06), VZ200(2005-09), VZ225(2003-09), VZ250(2003-09), VZ300(2004-09), Z250(2003-05), Z300(2004-06)



**18-99140
HEAD GASKET**
Replaces: 63V-11181-A1, 63V-11181-A2
Fits: 9.9(1997-08), 15(1997-08)



**18-99141
COVER GASKET**
Replaces: 6H3-11193-A1
Fits: 60(2001-05), 70(1984-09), C60(1996-01), C70(2000-01), E60(1995-00), P60(1991-99)



**18-99142
THERMOSTAT GASKET**
Replaces: 6E9-12414-A0, 6E9-12414-A1
Fits: C40(1992-97)



**18-99143
VALVE SEAL GASKET**
Replaces: 6H3-13621-A1
Fits: 60(2001-05), 70(1992-09), C60(1996-01), C70(2000-01), E60(1995-00), P60(1992-99)



**18-99144
MIXING COVER GASKET**
Replaces: 6E7-14227-00
Fits: 9.9(1984-95), 15(1984-95)









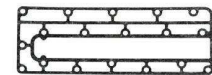

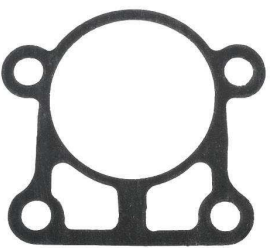
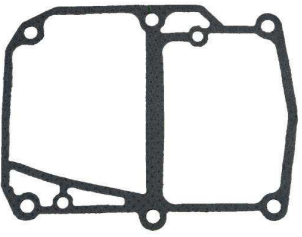
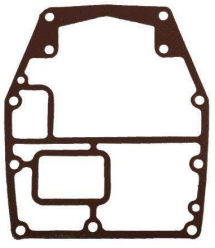
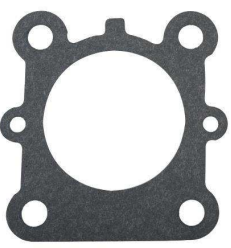

**18-99145
CARBURETOR GASKET**
Replaces: 677-14198-00, 677-14198-A1
Fits: 9.9(1984-91), 15(1984-91)

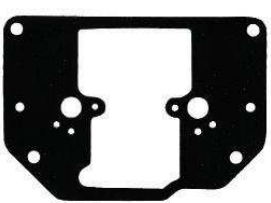

**18-99147
FUEL PUMP GASKET**
Replaces: 6G1-24431-01
Fits: 3(1990-02), 6(1990-00), 8(1990-09), 9.9(1996-09), 15(1996-09)

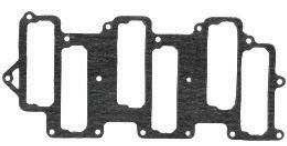

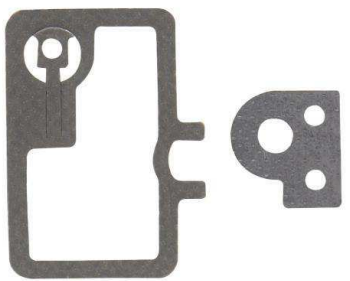







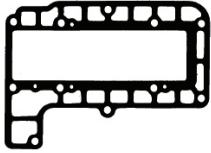
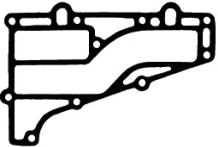
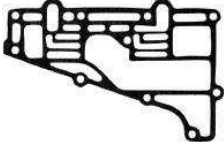



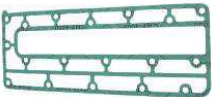









**18-99148
OUTER EXHAUST COVER GASKET**
Replaces: 688-41114-A0
Fits: 90(1992-09), B90(1998-99), C75(1994-99), C80(1997), C85(1992-96), C90(1997-01), E75(1995-00), P75(1996-99)



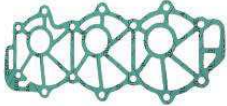

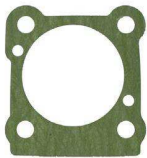







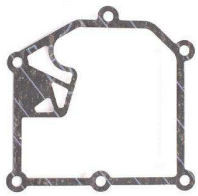
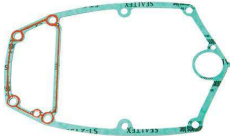
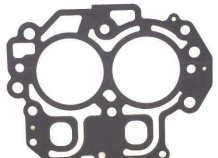

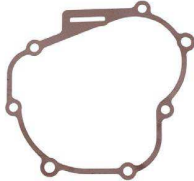
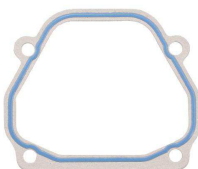

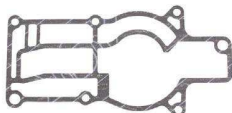
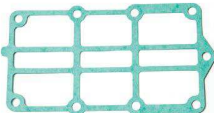
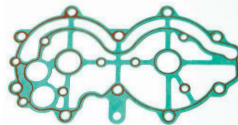
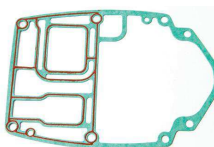

 <p>18-99149 WATER PUMP GASKET Replaces: 663-44316-A0 Fits: 25(1997-02), 30(1992-01), 40(1992-94), 50(1992-94), C30(1995), C55(1992-95), E48(1995-00), P50(1992-94)</p>	 <p>18-99150 UPPER CASING GASKET Replaces: 63V-45113-A1 Fits: 9.9(1997-09), 15(1997-09)</p>	 <p>18-99151 UPPER CASING GASKET Replaces: 688-45113-A0 Fits: 90(1984-09), B90(1997-99), C75(1994-99), C80(1997), C85(1991-96), C90(1997-01), C85(1989-90), E75(1995-00), P75(1996-99)</p>	
 <p>18-99152 LOWER CASING GASKET Replaces: 683-45315-A0 Fits: 9.9(1984-95), 15(1984-95), F9.9(1986-05)</p>	 <p>18-0765 FLOAT CHAMBER GASKET Replaces: 6L2-14384-00-00</p>	<p>PKG. OF 2</p>  <p>18-0775 18-0775-9① CARB MOUNTING GASKET Replaces: 648-14198-A0-00</p>	 <p>18-0785 CARB MOUNTING GASKET Replaces: 6E5-14198-A1-00</p>
 <p>18-0786 FLOAT CHAMBER GASKET Replaces: 6E5-14384-02-00</p>	 <p>18-2592 FLOAT BOWL GASKET Replaces: 6E5-14384-03-00 For: V-4 Outboards: 115, 130, 150, 175, 200, 225 (1986-96) V-6 Special & Excel (1986-89)</p>	 <p>18-0840-1 FLOAT CHAMBER GASKET Replaces: 676-14984-00-00</p>	 <p>18-0807-1 REED PLATE GASKET Replaces: 6K7-13645-A1-00</p>
 <p>18-0809 REED BLOCK GASKET Replaces: 6G5-13645-A1-00</p>	 <p>18-64415 O₂ SENSOR KIT Replaces: 68F-W1135-00-00 Fits: Yamaha DX150(2001-05), LX150(2001), LX200(2001), LX225(2001-02), LX250(2001-02), LZ150(2000-05), LZ200(2000-12), SX150(2001-04), SX200(2001-05), SX225(2001-02), SX250(2001-02), VX150(2001-04), VX200(2001-02), VX225(2001-02), VZ150(2000-14), VZ175(2001-12), VZ200(2001-04), Z150(2000-05), Z175(2001-05), Z200(2000-12)</p>	 <p>18-0808 PRESSURE CONTROL VALVE GASKET Replaces: 6G5-11382-A1-00</p>	

SEE PAGES 201-202 FOR OUR COMPLETE LINE OF GASKET SEALANTS

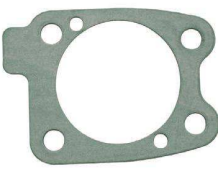
① Priced per Package

 <p>18-0250 EXHAUST COVER GASKET Replaces: 664-41114-A0-00</p>	 <p>18-0743 INNER EXHAUST COVER GASKET Replaces: 6L2-41112-A1-00</p>	 <p>18-0744 OUTER EXHAUST COVER GASKET Replaces: 6L2-41114-A1-00</p>	 <p>18-0798 EXHAUST COVER GASKET Replaces: 6H4-41114-A0-00</p>	 <p>18-0799 EXHAUST COVER GASKET Replaces: 6E5-41112-A1-00</p>
 <p>18-0812 EXHAUST COVER GASKET Replaces: 6G5-41112-A1-00</p>	 <p>18-0823 EXHAUST MANIFOLD GASKET Replaces: 6E5-13645-A1-00</p>	 <p>18-0847 EXHAUST COVER GASKET Replaces: 688-41112-A0-00 Fits: 90 HP</p>	 <p>18-0739 UPPER CASING GASKET Replaces: 689-45113-A1-00</p>	 <p>18-0813 POWERHEAD BASE GASKET Replaces: 6G5-45113-A0-00</p>
 <p>18-0232 COVER GASKET Replaces: 655-12414-A1-00</p>	 <p>18-0782 COVER GASKET Replaces: 6E5-11381-A1-00</p>	 <p>18-0829 COVER GASKET Replaces: 61A-12414-A0-00 6J8-12414-A0-00</p>	 <p>New 18-99127 THERMOSTAT GASKET Replaces: 63P-12414-00-00 Fits: F150/LF150 (2004-11), F150A/LF150A (2012-14), F150B/LF150B (2015-18)</p>	 <p>18-0754 THERMOSTAT GASKET Replaces: 68D-E2414-A0-00 Fits: F2.5MSH-0405, F2.5MSH-0407, F2.5MSH0608, F2.5MSHD-2007</p>
 <p>18-0835 THERMOSTAT GASKET Replaces: 62Y-12414-00-00 Fits: F 9.9, T9.9 (2005-06), 15 (2006), F15, F25 (1998-06), T25, F30 (2001-06), F40 4cyl (1999), F40 3cyl (2000-06), F50 (1996-06), T50 (1996-06), F60 (2002-06), T60 (2003-06)</p>	 <p>18-0836 THERMOSTAT GASKET Replaces: 682-12414-A1-00 Fits: 9.9, 15 (1984-06)</p>	 <p>18-0844 THERMOSTAT GASKET Replaces: 688-12414-A1-00 Fits: 90 HP V-4, V-6</p>	 <p>18-0767 WATER JACKET GASKET Replaces: 688-11193-01-00 Fits: 90 HP</p>	 <p>18-0779 WATER JACKET GASKET Replaces: 6G5-11193-A0-00</p>
 <p>18-0781 WATER JACKET GASKET Replaces: 6E5-11193-A0-00</p>	 <p>18-0815 WATER JACKET GASKET Replaces: 6H4-11193-A1-00</p>	 <p>18-0483 PUMP CASE GASKET Replaces: 63D-44316-00-00 Fits: 40 (1995-04), 50 (1995-97, 1999-04)</p>	 <p>18-0753 WATER PUMP GASKET Replaces: 6G1-44315-A0-00 Fits: 6 (1986-00), 8 (1984-05)</p>	 <p>18-0239 WATER PUMP GASKET Replaces: 688-44315-A0-00</p>

SEE PAGES 201-202 FOR OUR COMPLETE LINE OF GASKET SEALANTS

 <p>18-3458 WATER PUMP GASKET Replaces: 6CE-44315-00-00 Fits: F225 (2010-15), F250 (2010), F250 (2010-15), F300 (2007-15), F350 (2007-15), FL250 (2010), FL300 (2010), FL350 (2010), LF225 (2010-15), LF250 (2010-15), LF300 (2007-15), LF350 (2007-15), VF250 (2015)</p>	 <p>18-60512 BREATHER GASKET Replaces: 68D-E1169-A0-00 Fits: Yamaha F4(2002-08)</p>	 <p>18-60521 CYLINDER COVER GASKET Replaces: 69M-11196-A0-00 Fits: Yamaha F2.5(2003-14), F4(1999-14), F6(2009-14)</p>	 <p>18-60529 EXHAUST MANIFOLD GASKET Replaces: 66T-41133-A0-00 Fits: Yamaha T40/T30 Enduro Series</p>	 <p>18-63966 CYLINDER HEAD GASKET Replaces: 66M-11181-10-00 Fits: Yamaha F9.9(2005-06), F15(2005-06), T9.9(2005-06)</p>
 <p>18-63968 CYLINDER HEAD GASKET Replaces: 65W-11181-30-00 Fits: F25(2005), T25(2005-06)</p>	 <p>18-60522 CYLINDER COVER GASKET Replaces: 66T-11181-A0-00 Fits: Yamaha F2.5(2003-14), F4(1999-14), F6(2009-14)</p>	 <p>18-60518 CRANKCASE GASKET Replaces: 68D-11351-A0-00 Fits: Yamaha F4(2002-08)</p>	 <p>18-60519 CRANKCASE GASKET Replaces: 68D-E1193-A0-00 Fits: Yamaha F4(2002-08)</p>	 <p>18-60530 EXHAUST OUTER COVER GASKET Replaces: 66M-41114-01-00 Fits: Yamaha F9.9(2005-06), F15(2005-06), T9.9(2005-06)</p>
 <p>18-60531 EXHAUST OUTER COVER GASKET Replaces: 65W-41114-01-00 Fits: Yamaha F25</p>	 <p>18-60523 CYLINDER COVER GASKET Replaces: 69M-11181-00-00 Fits: Yamaha F2.5(2003 & Up)</p>	 <p>18-60527 ENGINE GASKET Replaces: 67D-45113-A0-00 Fits: Yamaha F4(1999-08)</p>	 <p>18-60532 EXHAUST OUTER COVER GASKET Replaces: 66T-41114-A0-00 Fits: Yamaha T40/T30 Enduro Series</p>	 <p>18-60520 CYLINDER COVER GASKET Replaces: 66T-11193-A0-00 Fits: Yamaha T40/T30 Enduro Series</p>
 <p>18-60528 ENGINE GASKET Replaces: 66T-45113-A0-00 Fits: Yamaha T40/T30 Enduro Series</p>	 <p>18-60534 MANIFOLD GASKET Replaces: 66M-13645-00-00 Fits: Yamaha F9.9(2005-06), F15(1998-06), T9.9(2005-06)</p>	 <p>18-60535 MANIFOLD GASKET Replaces: 65W-13645-00-00 Fits: F25(1998-05), T25(2001-06)</p>	 <p>18-60540 THERMOSTAT GASKET Replaces: 676-12414-A0-00 For: Yamaha T40/T30 Enduro Series</p>	 <p>18-60541 WATER PUMP COVER GASKET Replaces: 6BX-G4315-01-00 Fits: F4(2009-14), F6(2009-14)</p>
 <p>18-0240 WATER PUMP GASKET Replaces: 688-44316-A0-00</p>	 <p>18-0244 WATER PUMP GASKET Replaces: 6E5-44315-A0-00</p>	 <p>18-0292 WEAR PLATE TO PUMP HOUSING GASKET Replaces: 663-44315-A0-00</p>	<p>PKG. OF 2</p>  <p>18-0294 18-0294-9^① WEAR PLATE TO PUMP BASE GASKET Replaces: 663-44324-A0-00</p>	 <p>18-0756-1 WATER PUMP GASKET Replaces: 6H3-44315-A0-00</p>

 <p>18-60513 BREATHER GASKET Replaces: 66M-11357-00-00 Fits: Yamaha F9.9(2005-06), F15(1998-06), T9.9(2005-06)</p>	 <p>18-0757 OUTER PLATE GASKET Replaces: 6H3-44324-A0-00</p>	<p>PKG. OF 2</p>  <p>18-0768 18-0768-9Ⓜ WEAR PLATE GASKET Replaces: 682-44315-A0-00</p>	 <p>18-0826 DRAIN SCREW GASKET Replaces: 90430-14115-00 Fits: 40-90 HP</p>	 <p>18-1079 OIL SEAL PROTECTOR Replaces: 6GD-G4325-00-00 Fits: 2(1984-85, 1988-89)</p>
---	---	---	--	---

SEE PAGES 201-202 FOR OUR COMPLETE LINE OF GASKET SEALANTS

 <p>18-4274 PROP SPACER Replaces: 688-45997-01-00</p>	 <p>18-2448 LOWER UNIT FILL/DRAIN KIT M8 - 1.25 thread Fits: Yamaha, Nissan/Tohatsu, & Honda Lower Units</p>	 <p>18-4698 18-46981-9Ⓜ (PKG. OF 50) DRAIN FILL WASHER Replaces: 90430-08020-00</p>	 <p>18-2371 18-23711-9Ⓜ (PKG. OF 50) DRAIN SCREW M8 - 1.25 thread Replaces: 90340-08002-00, 90340-08M04-00 Uses Gasket 18-4698</p>	 <p>18-2374 18-23741-9Ⓜ (PKG. OF 50) MAGNETIC DRAIN SCREW M8 - 1.25 thread Replaces: 688-45341-00-00, 688-45341-10-00 Uses Gasket 18-4698</p>
--	---	---	--	--























 <p>18-2388 PROP SHAFT Replaces: 688-45611-00-00 For: F40 (1999) F50(1999-00) C60/C70/C90 (2000-01) C75 (1994) C85 (1991-94)</p>	 <p>18-2385 PROP SHAFT Replaces: 6E5-45611-01-00 For: 115/130HP</p>	<p>RECOIL STARTER SPRINGS</p>  <p>18-51001 Replaces: 63V-15713-00-00 Fits: 9.9(1996-09), 15(1996-09), F6(2001-08), F8(2001-14), F9.9(2005-14), F15(1998-14), F20(2006-14), T8(2002-10), T9.9(2007-14)</p> <p>18-51002 Replaces: 67D-15713-00-00 Fits: F2.5(2003-14), F4(1999-14), F6(2009-14)</p> <p>18-51003 Replaces: 66T-15713-00-00 Fits: F25(2009-14), F30(2001-05), F40(2001-08)</p>
--	---	--

Model	Year	Part #	Model	Year	Part #
40EJRP - 50TLHS	1984-1997	N/A	F115TLR	2006 & UP	18-2385
50ETSN - 50TLHS	1984-1994	N/A	F115TLRA - F115TLRZ	2001-2005	18-2385
T50TLRY - C90TLRZ	1989-2001	18-2388	F115TXR	2006 & UP	18-2385
50ETSK	1984-2001	18-2385	F115TXRA -200ETXN	1984-2004	18-2385
115TLR	2006 & UP	18-2385	V-6 SPECIAL	1985-1986	18-2385
115TLRA - 115TRR	1991-2005	18-2385	V-6 SPECIAL L	1984-1986	18-2385
115TXR	2006 & UP	18-2385	V-6 SPECIAL LK	1985	18-2385
115TXRA - 115TXRA	1991-2005	18-2385	V-6 SPECIAL X	1984-1986	18-2385
F115TJR	2006 & UP	18-2385	V-6 SPECIAL XK	1985	18-2385
F115TJRA - F115TJRD	2002-2005	18-2385			

 <p>18-2773 CARRIER BEARING Replaces: 663-45331-00-94 For: E48 (1995, 1997-00) / C55 (1991-95)</p>	 <p>18-2782 CARRIER BEARING Replaces: 688-45331-00-94 For: F40 (1999) F50/T50 (1996-00) 60 (2002-03) C60 (1996-01) E60 (1995-99) P60 (1991-99) 70 (1984-03) C70 (2000-01) C75 (1994-96 / 1998-99) E75 (1995-00) P75 (1996-99) C80 (1997) C85 (1991-96)</p>
---	---

Ⓜ Priced per Package

Zinc is for saltwater only applications.
 Magnesium is for fresh water only applications.
 Aluminum is for brackish water, or if boat is used in both fresh and salt environments.

 <p>18-6118A^① CYLINDER BLOCK ANODE Replaces: 68V-11325-01-00 Fits: F75-F250 / 2004 through April 2006 Production</p>	 <p>18-6119A^① 18-6119Z^③ TRIM TAB ANODE Replaces: 61A-45371-00-00</p>	 <p>18-6120A^① 18-6120Z^③ GEARCASE ANODE Replaces: 61N-45251-01-00</p>	 <p>18-6121A^① 18-6121Z^③ TRIM TAB ANODE Replaces: 6K1-45371-02-00 Fits: FL150 (2004-2005); L150 - L200 (1987-2002)</p>	 <p>18-6122A^① 18-6122Z^③ TRIM TAB ANODE Replaces: 69L-45371-00-00 Fits: VZ200 - VZ300 / 3.3L (2005-Current), VX225 - VX250 / 2.6L (2002-2005), Z250 - Z300 / 3.3L (2004-Current)</p>															
 <p>18-6246 TRIM TAB BOLT Replaces: 90105-10M00-00 M10 - 1.25 x 45mm thread</p>	 <p>18-6034^③ ANODE Replaces: 6K1-45371-00-00 For use on lower drive 150,200 HP (1986)</p>	 <p>18-6112^② 18-6035^③ ANODE Replaces: 6J9-45371-01-00 For: 150-200 HP</p>	 <p>18-6111^② 18-6070^③ ANODE Replaces: 688-45371-02-00 For use on lower casing drive For: 60, 70, 90HP (1984-04) C60, C75, C85, C90 (1994-01), E60, E75 (1995-00), F50 (1996-00), P60, P75 (1991-99), T50 (1996-00)</p>	 <p>18-6090^③ ANODE Replaces: 6G5-45251-01-00 For use on transom bracket For: 115-225HP (1988-02)</p>															
 <p>18-6091^③ ANODE Replaces: 6H1-45251-02-00 For: 40-90 HP</p>	 <p>18-6096^③ ANODE Replaces: 664-45371-01-00 For: 20-50 HP</p>	 <p>18-6097^③ ANODE Replaces: 6E5-45371-01-00 For use on lower casing drive For: 115, 130 HP(1984-04), V6 Special (1985-86)</p>	 <p>18-6132A^① 18-6132M^② ANODE For: Yamaha 200-250 Outboards</p>	 <p>18-6133A^① 18-6133M^② ANODE Fits: Yamaha 150-200 Outboards</p>															
 <p>18-6162A^① 18-6162M^② ANODE KIT Fits: Yamaha 60-90HP Engines</p>	<p style="text-align: center;">COTTER PINS</p> <table border="1"> <thead> <tr> <th>Part #</th> <th>O.E. #</th> <th>Pkg of</th> </tr> </thead> <tbody> <tr> <td>18-2380</td> <td>91490-30030-00, 91401-30030-00, 91401-30028-00, 91402-30028-09, 91402-30028-00, 91402-30022-09, 91402-30022-00</td> <td>10</td> </tr> <tr> <td>18-3735</td> <td>91490-40030-00</td> <td>10</td> </tr> <tr> <td>18-3748</td> <td>91490-30045-00</td> <td>5</td> </tr> <tr> <td>18-73893</td> <td>91490-25030-00</td> <td>1</td> </tr> </tbody> </table>		Part #	O.E. #	Pkg of	18-2380	91490-30030-00, 91401-30030-00, 91401-30028-00, 91402-30028-09, 91402-30028-00, 91402-30022-09, 91402-30022-00	10	18-3735	91490-40030-00	10	18-3748	91490-30045-00	5	18-73893	91490-25030-00	1	 <p>18-73891 PROP SPACER Replaces: 68D-G5987-00-00 Fits: Yamaha F2.5(2001 & Up), F4(2001 & Up), F6(2006 & Up)</p>	 <p>18-73914 PROP SPACER Replaces: 670-45997-02-00 Fits: Yamaha 40-50(1984-05)</p>
Part #	O.E. #	Pkg of																	
18-2380	91490-30030-00, 91401-30030-00, 91401-30028-00, 91402-30028-09, 91402-30028-00, 91402-30022-09, 91402-30022-00	10																	
18-3735	91490-40030-00	10																	
18-3748	91490-30045-00	5																	
18-73893	91490-25030-00	1																	
 <p>18-73918 PROP THRUST WASHER Replaces: 63P-45987-00-00, 6E5-45987-01-00 Fits: Yamaha F115-F200(2004-14)</p>	 <p>18-73979 PROP THRUST WASHER Replaces: 6L2-45987-01-00 Fits: Yamaha 25(1988-09), 30(1990-02), C30(1994-97), F25(1998-14)</p>	 <p>18-73978 PROP NUT WASHER Replaces: 90201-08M54-00 Fits: Yamaha Multiple Applications</p>	 <p>18-73990 PROP NUT KIT Fits: Yamaha 40(1984-01), 50(1984-95), C55, F40-F50(1995-00)</p>	 <p>18-73993 PROP NUT KIT Fits: Yamaha F9.9/15</p>															

① Aluminum ② Magnesium ③ Zinc



**18-73994
PROP NUT KIT**
Replaces: Yamaha F2.5/F4(2001 & Up), F6(2006 & Up)



**18-73892
PROP NUT**
Replaces: 6L5-45616-00-00
Fits: Yamaha 2.5-6(1988 & Up)



18-3781D Display Package

**18-3781
PROP NUT KIT**
Replaces: 6H1-W4599-00-00
For: T50, C60, E60, P60, 70, C75, C80, C85, 90
— CONTAINS —

Part #	O.E. #	Desc.
18-3732	90171-16011-00	Prop Nut
18-4274	688-45997-01	Spacer
18-2380	91490-30030	Cotter Pin



18-3782D Display Package

**18-3782
PROP NUT KIT**
Replaces: 6G5-W4599-00-00
— CONTAINS —

Part #	O.E. #	Desc.
18-3726	90171-18M04	Prop Nut
18-4274	688-45997-01	Spacer
18-3735	91490-40030	Cotter Pin

ALL V-4 & V-6 (Except D150)



**18-3771
PROP NUT KIT**
Replaces: 689-W4599-00
— CONTAINS —

Part #	O.E. #	Desc.
18-3791	689-45997-00	Spacer
18-3792	90171-14013-00	Prop Nut
18-2380	91490-30030-00	Cotter Pin



**18-3709
PROP NUT**
Replaces: 647-45616-02
Fits: 4(1984-91), 5(1984-85)



**18-3726
PROP NUT**
Replaces: 90171-18M04
For: All V-4 & V-6 (Except D150)



**18-3732
PROP NUT**
Replaces: 90171-16011-00
95307-16900-00
Fits: Yamaha 20-30 hp(1980 & Up)



**18-37307
PROP NUT**
Replaces: 90171-14056-00
Fits: Yamaha 20-30 HP (1980 & up)



**18-3773
PROP NUT**
Replaces: 90171-10M01
Fits: 6(1986-00), 8(1986-09), 9.9(1984-09), 15(1984-09), F6(2001-08), F8(2001-12), F9.9(1985-12), F15(1998-13), F20(2006-13)



**18-3791
SPACER**
Replaces: 689-45997-00



**18-3792
PROP NUT**
Replaces: 90171-14013-00,
90171-14056-00



**18-79989
TRAILERING STICKS**
Fits: Most outboards over 150hp with three ram intrigrel tilt/trim.

HP/Model	Years	Nut #	Spacer #	Cotter Pin #	Kit #
2(6A1)	1984-95	—	—	18-3748	—
4(6E0)	1984-90	—	—	18-3748	—
4(6E0)	1991	—	—	18-2380	—
5	1984-85	—	—	18-3748	—
9.9(6GB)	1984-85	—	—	18-3748	—
20	1996-97	18-3792	18-3791	18-2380	18-3771
25(6H7)(6L2)	1984-09	18-3792	18-3791	18-2380	18-3771
C25(695)	1991-97	18-3792	18-3791	18-2380	18-3771
CV25	1990	18-3792	18-3791	18-2380	18-3771
F25	1998-05, 2009-10	18-3792	18-3791	18-2380	18-3771
30(689)(6J8)	1984-02	18-3792	18-3791	18-2380	18-3771
C30(689)(61T)	1991-97	18-3792	18-3791	18-2380	18-3771
CV30	1990	18-3792	18-3791	18-2380	18-3771
40(6H4)(63B,C,D)	1984-05	18-3732	—	18-2380	—
C40(6R6)	1990-03	18-3732	—	18-2380/18-3748	—
50(6H5)(62X)	1984-09	18-3732	—	18-2380/18-3748	—
PRO50(6H5)(62X)	1987-90	18-3732	—	18-2380	—
T50	2001-10	18-3732	18-3789	18-3735	18-3772
C55(697)	1991-95	18-3732	—	18-3735	—
60	2004-05	18-3732	18-3789	18-3735	18-3772
P60(6H2)	1991-99	18-3732	18-4274	18-3735	18-3781
T60	2003-10	18-3732	18-3789	18-3735	18-3772
70(6H3)	1984-03	18-3732	18-4274	18-3735	18-3781
70	2004-09	18-3732	18-3789	18-3735	18-3772
F70	2010	18-3732	18-3789	18-3735	18-3772
C75(692)	1994-99	18-3732	18-4274	18-3735	18-3781
F75	2003-10	18-3732	18-3789	18-3735	18-3772
F80	1999-03	18-3732	18-3789	18-3735	18-3772
C85(688)	1991-96	18-3732	18-4274	18-3735	18-3781
90(6H1)	1984-03	18-3732	18-4274	18-3735	18-3781
90	2004-09	18-3732	18-3789	18-3735	18-3772
F90	2003-10	18-3732	18-3789	18-3735	18-3772
F100	1999-03	18-3732	18-3789	18-3735	18-3772
115(6E5)(6N6)	1984-09	18-3726	18-4274	18-3735	18-3782
C115(6E5)	1991-00	18-3726	18-4274	18-3735	18-3782
P115(62A)	1993-96	18-3726	18-4274	18-3735	18-3782
130(6L1)(6N7)	1988-04	18-3726	18-4274	18-3735	18-3782
L130(6L6)(6N4)	1989-01	18-3726	18-4274	18-3735	18-3782
150(6G4)(6R2)	1984-09	18-3726	18-4274	18-3735	18-3782
PRO V 150, (6J9)(6N9)	1986-90	18-3726	18-4274	18-3735	18-3782
P150(6N9)	1991-99	18-3726	18-4274	18-3735	18-3782
L150(6RO)	1986-99	18-3726	18-4274	18-3735	18-3782
175(6G5)(6R3)	1984-00	18-3726	18-4274	18-3735	18-3782
P175(62H)	1994-99	18-3726	18-4274	18-3735	18-3782
200(6G6)(6R4)	1984-95	18-3726	18-4274	18-3735	18-3782
L200(6K1)(6R1)	1987-99	18-3726	18-4274	18-3735	18-3782
P200(61H)	1991-99	18-3726	18-4274	18-3735	18-3782
225(6R5)(62J)	1990-97	18-3726	18-4274	18-3735	18-3782
L225(62K)	1994-99	18-3726	18-4274	18-3735	18-3782
250(61A)	1990-95	18-3726	18-4274	18-3735	18-3782
L250(61B)	1990-99	18-3726	18-4274	18-3735	18-3782
V6 SPECIAL(6G7)	1984-86	18-3726	18-4274	18-3735	18-3782
V6 EXCEL(6K7)	1987-89	18-3726	18-4274	18-3735	18-3782

① Items ending in "D" are Display Packaged - Regular number is Non-Display
 ② This product is priced per piece. To order price per package, please add -9 to the part number.



QUALITY is ASSURED

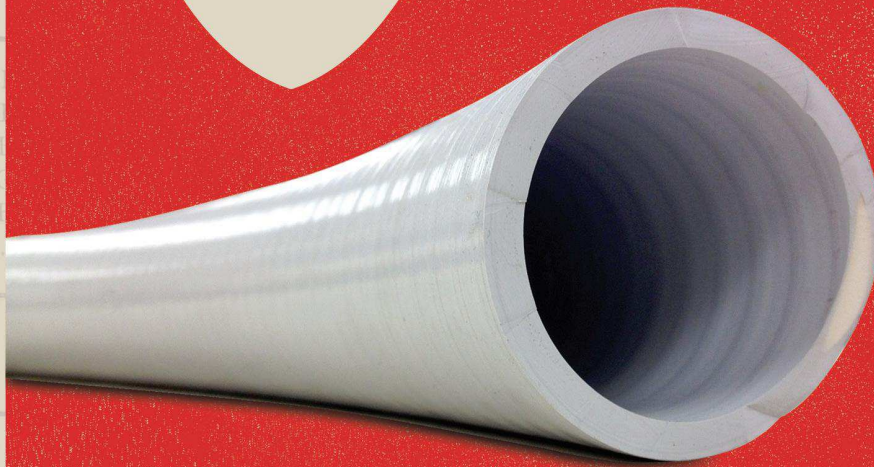

Shields Marine manufactures a wide variety of hoses for applications onboard pleasure craft. Serving as conduits for fluids, air or exhaust, each Shields hose is designed for a specific application and meets strict standards set by the USCG, ABYC and other regulatory agencies.

Three of our marine exhaust hoses have qualified for Lloyd's Register Type Approval, meeting the highest standards of production quality.

See pages 63-109 for product offering.



The Very Best Parts of Boating
www.sierramarine.com

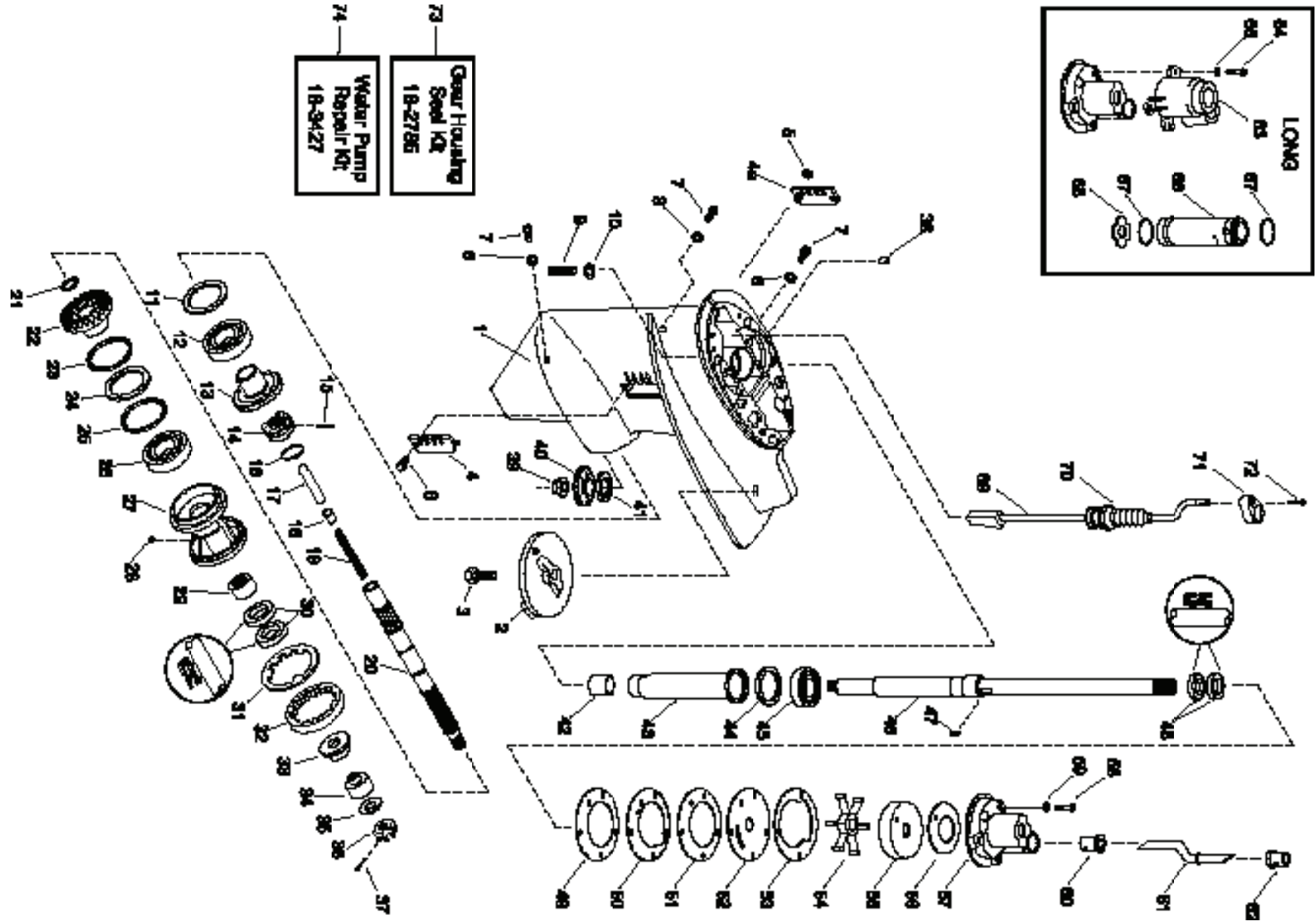

Figure #	Description	Part #	O.E.M. #	Qty.	Figure #	Description	Part #	O.E.M. #	Qty.
1	Housing, Gearcase	—	689-45311-04-EK3	1	37	Cotter Pin	18-2380	91490-30030-00	
2	Trim Tab	18-6096A, 18-6113	664-45371-01-00	1	38	Pin, Dowel	—	93606-12019-00	2
					39	Nut, Pinion	—	90179-09M02-00	2
3	Bolt, Trim Tab	—	90105-08M02-00	1	40	Gear, Pinion	—	689-45551-00-00	1
4	Cover, Water Inlet (port)	—	689-45214-01-01	1	41	Bearing, Thrust	—	664-45552-09-00	1
4a	Cover, Water Inlet (stbd)	—	689-45215-01-00	1	42	Bearing, Pinion	—	93315-017U4-00	1
5	Nut, Nylock	—	90185-05904-00	1	43	Sleeve, Drive Shaft	—	689-45536-00-00	1
6	Bolt, Water Inlet	—	98680-05525-00	1	44	Shim Pinion Gear (0.5mm)	—	664-45587-00-05	AR
7	Plug, Drain & Vent	—	90340-08M04-00	3		Shim Pinion Gear (0.8mm)	—	664-45587-00-08	AR
8	Gasket, Plug	—	90430-08020-00	3		Shim Pinion Gear (0.12mm)	—	664-45587-01-12	AR
9	Bolt, Gearcase Mounting	—	90105-10059-00	2		Shim Pinion Gear (0.30mm)	—	664-45587-01-30	AR
10	Washer, Gearcase Mounting	—	92990-10600-00	4		Shim Pinion Gear (0.50mm)	—	664-45587-01-50	AR
11	Shim Forward Gear (0.5mm)	—	664-45567-00-05	AR	45	Bearing, Drive Shaft	—	93332-000U4-00	1
	Shim Forward Gear (0.8mm)	—	664-45567-00-08	AR	46	Drive Shaft (long)	—	689-45501-10-00	1
	Shim Forward Gear (0.12mm)	—	664-45567-01-12	AR	47	Key, Impeller	—	664-44338-00-00	1
	Shim Forward Gear (0.30mm)	—	664-45567-01-30	AR	48	Oil Seal, Pump Base	18-0296	93101-22067-00	2
	Shim Forward Gear (0.50mm)	—	664-45567-01-50	AR	49	Gasket, Base	18-0773	689-44316-A0-00	1
12	Bearing, Forward Gear	—	93332-00005-00	1	50	Base, Water Pump	—	689-44325-02-5B	1
13	Gear, Forward	—	689-45560-00-00	1	51	Gasket, Base	18-0773	689-44316-A0-00	1
14	Clutch, Dog	—	664-45631-01-00	1	52	Impeller Plate	—	689-44323-03-00	1
15	Pin, Clutch Dog	—	90250-05010-00	1	53	Gasket, Impeller Plate	—	689-44324-A0-00	1
16	Ring, Cross Pin	—	648-45633-00-00	1	54	Impeller	18-3067	689-44352-02-00	1
17	Plunger, Shift	—	648-45635-00-00	1	55	Insert Cup	18-3439	689-W4432-02-00	1
18	Slide, Shift	—	648-45634-00-00	1	56	Damper, Water Seal	—	689-44367-01-00	1
19	Spring, Compression	—	90501-10065-00	1	57	Housing, Water Pump	—	689-44311-03-00	1
20	Shaft, Propeller	—	689-45611-00-00	1	58	Bolt, Pump Housing	—	90101-06M56-00	3
21	Thrust, Washer, Prop Shaft	—	90201-20417-00	1	59	Washer, Housing (short shaft)	—	90209-06M04-00	3
22	Gear, Reverse	—	689-45571-00-00	1	60	Seal, Lower Water Tube	—	626-44365-01-00	1
23	Shim Reverse Gear (0.5mm)	—	664-45577-00-05	AR	61	Water Tube (long shaft)	—	689-44361-10-00	1
	Shim Reverse Gear (0.8mm)	—	664-45577-00-08	AR	62	Seal, Upper Water Tube	18-0552	689-44366-00-00	1
	Shim Reverse Gear (0.12mm)	—	664-45577-01-12	AR	63	Extension, Housing (long shaft)	—	689-44312-00-5B	1
	Shim Reverse Gear (0.30mm)	—	664-45577-01-30	AR	64	Bolt, Extension (long shaft)	—	97080-06035-00	3
	Shim Reverse Gear (0.50mm)	—	664-45577-01-50	AR	65	Washer, Bolt (long shaft)	—	92990-06600-00	3
24	Washer Thrust	—	664-45576-00-00	1	66	Extension Tube (long shaft)	—	689-44362-00-94	1
25	O-Ring, Bearing Carrier	—	93210-30MA3-00	1	67	O-Ring, Extension Tube	—	93210-26240-00	2
26	Bearing, Reverse Gear	—	93306-00612-00	1	68	Plate (long shaft)	—	689-44328-03-00	1
27	Bearing, Carrier	—	689-45331-01-94	1	69	Shift Cam Assembly (short shaft)	—	664-44150-01-00	1
28	Key, Bearing Carrier	—	90282-04010-00	1	69	Shift Cam Assembly (long shaft)	—	664-44150-11-00	1
29	Bearing, Prop Shaft	—	93315-22004-00	1	70	Boot, Shift Rod	—	664-44147-00-00	1
30	Seal, Prop Shaft	18-0554	93101-20M07-00	2	71	Bracket, Shift Shaft	—	689-44176-01-00	1
31	Tab Washer	—	90214-45M02-00	1	72	Screw, Bracket	—	97780-50610-00	1
32	Nut, Cover	—	664-45384-00-00	1	73	Gear Housing Seal Kit	18-2785	689-W0001-22-00	1
33	Prop Spacer (fore)	—	664-45987-01-00	1	74	Water Pump Repair Kit	18-3427	689-W0078-A6-00	1
34	Prop Spacer (aft)	—	689-45997-00-00	1					
35	Washer, Prop Mounting	—	92990-14200-00	1					
36	Nut, Propeller	—	90171-14013-00	1					

AR As required

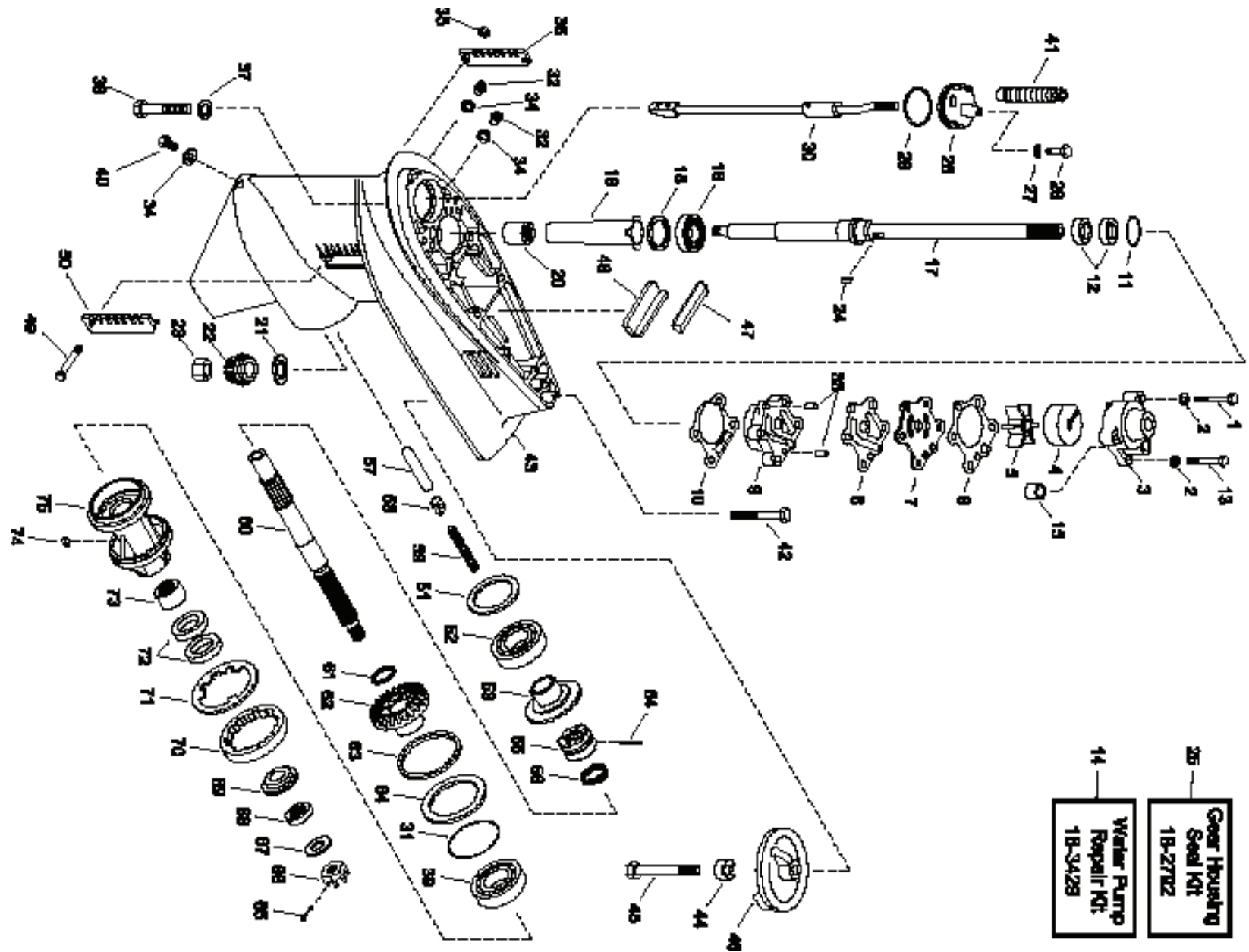
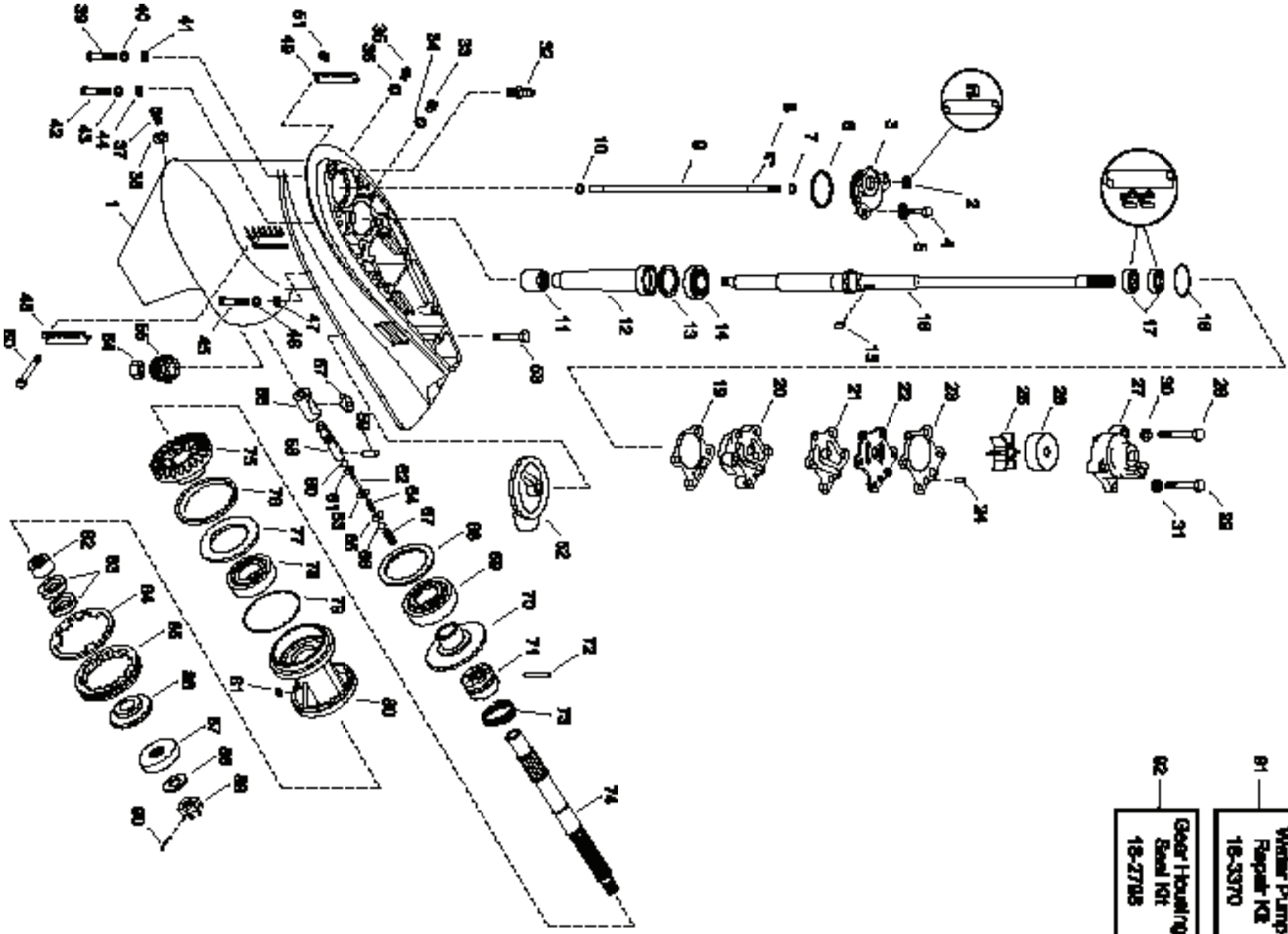

Figure #	Description	Part #	O.E.M. #	Qty.	Figure #	Description	Part #	O.E.M. #	Qty.
1	Bolt, Water Pump Housing	—	97395-08055-00	2	39	Bearing, Ball	—	93306-00702-00	1
2	Washer, Water Pump Housing	—	92990-08600-00	4	40	Plug, Drain	18-2374	688-45341-00-00	1
3	Housing, Water Pump	—	663-44311-02-00	1	41	Propeller	—	various	1
4	Insert, Water Pump	18-3435	663-44322-00-00	1	42	Bolt, Trim Tab	—	97575-08675-00	1
5	Impeller	18-3068	6H4-44352-02-00	1	43	Casing, Lower	—	6H4-45301-01-EK	1
6	Gasket, Wear Plate to Water Pump	18-0292	663-44315-A0-00	1	44	Washer, Locking	—	92990=08100-00	1
					45	Bolt, Lower Casing	—	97095-08085-00	1
7	Wear Plate, Water Pump	18-3436	663-44323-00-00	1	46	Tab, Trim	18-6096A	664-45371-01-00	1
8	Gasket, Wear Plate to Water Pump	18-0294	663-44324-A0-00	1	47	Seal Rubber	—	688-45375-00-00	1
					48	Guide, Seal Rubber	—	663-45376-00-94	1
9	Base, Water Pump	—	663-44341-00-94	1	49	Screw Ovalhead	—	98780-05535-00	1
10	Gasket, Pump Base	—	663-44316-A0-00	1	50	Cover, Water Inlet (port)	—	668-45214,02-00	1
11	O-Ring, Pump Base	18-0298	93210-41042-00	1	51	Shim Forward Gear (0.5mm)	—	6H4-45567-00-05	1
12	Oil Seal, Pump Base	18-0297	93101-23070-00	2		Shim Forward Gear (0.8mm)	—	6H4-45567-00-08	AR
13	Bolt, Water Pump Housing	18-0256	97095-08045-00	2		Shim Forward Gear (0.12mm)	—	6H4-45567-01-12	AR
14	Water Pump Repair Kit	18-3429	6H4-W0078-00-00	1		Shim Forward Gear (0.30mm)	—	6H4-45567-01-30	AR
15	Water Seal	—	663-44366-00-00	1		Shim Forward Gear (0.50mm)	—	6H4-45567-01-50	AR
16	Bearing, Tapered Roller	—	93332-00079-00	1	52	Bearing, Tapered Roller	—	93332-000V4-00	1
17	Drive Shaft (Short)	—	6H4-45501-00-00	1	53	Gear, Forward	—	6H4-45560-00-00	1
17	Drive Shaft (Long)	—	6H4-45501-10-01	1	54	Pin, Cross (clutch dog)	—	90250-06023-00	1
18	Shim (0.5mm)	—	663-45587-00-05	AR	55	Clutch, Sliding	—	663-45631-01-00	1
	Shim (0.8mm)	—	663-45587-00-08	AR	56	Retainer Ring, Cross Pin	—	663-45633-00-00	1
	Shim (0.12mm)	—	663-45587-01-12	AR	57	Plunger, Shift	—	676-45635-00-00	1
	Shim (0.30mm)	—	663-45587-01-30	AR	58	Slide, Shift	—	663-45634-00-00	1
	Shim (0.50mm)	—	663-45587-01-50	AR	59	Spring, Compression	—	60501-16M01-00	1
19	Sleeve, Drive Shaft	—	6H4-45536-00-0	1	60	Shaft, Propeller	—	679-45611-01-00	1
20	Bearing, Needle	—	93315-32224-00	1	61	Washer, Plate	—	90201-22429-00	1
21	Bearing (not used 1988 & later)	—	663-45552-00-00	1	62	Gear, Reverse	—	6H4-45571-00-00	1
22	Gear, Pinion	—	6H4-45551-00-00	1	63	Shim Reverse Gear (0.5mm)	—	663-45577-00-05	AR
23	Nut, Pinion Gear	—	90170-12138-00	1		Shim Reverse Gear (0.8mm)	—	663-45577-00-08	AR
24	Key, Woodruff	18-3305	90280-03024-00	1		Shim Reverse Gear (0.12mm)	—	663-45577-01-12	AR
25	Gearcase Seal Kit	18-2792	6H4-W0001-20-00	1		Shim Reverse Gear (0.30mm)	—	663-45577-01-30	AR
26	Bolt, Plate	—	97095-06016-00	1		Shim Reverse Gear (0.50mm)	—	663-45577-01-50	AR
27	Washer, Plate	—	92990-06600-00	1	64	Washer, Thrust	—	663-45576-00-00	1
28	Plate	—	6H4-45321-01-00	1	65	Pin, Cotter	18-2380	91490-30030-00	1
29	O-Ring, Plate	—	93210-49046-00	1	66	Nut, Castle	18-3732	90171-16011-11	1
30	Shift Cam Assembly (short shaft)	—	6H4-44150-01-00	1	67	Washer	—	92990-16200-00	1
	Shift Cam Assembly (long shaft)	—	6H4-44150-12-01	1	68	Spacer, Prop Mounting (aft)	—	670-45997-02-00	1
31	O-Ring, Bearing Housing	18-0299	93210-66M98-00	1	69	Spacer, Prop Mounting (fore)	—	663-45987-02-00	1
32	Plug, Vent	—	90340-08M04-00	2	70	Nut, Cover	—	697-45385-00-00	1
33	Pin, Dowel	—	93604-08062-00	2	71	Washer, Tab	—	90214-48M03-00	1
34	Gasket, Drain Plug	—	90430-08020-00	3	72	Oil Seal, Bearing Housing	18-0296	93101-22067-00	2
35	Nut, Nylock	—	90185-05904-00	1	73	Bearing, Needle	—	93317-22204-00	1
36	Cover, Water Inlet (stbd)	—	688-45215-02-00	1	74	Key, Bearing Housing	—	90282-04010-00	1
37	Washer, Locking	—	92990-10100-00	4	75	Housing, Bearing	—	679-45331-00-94	1
38	Bolt	—	97078-10040-00	4					

AR As required



- 01 — Water Pump Repair Kit 18-3370
- 02 — Gear Housing Seal Kit 18-2708

Figure #	Description	Part #	O.E.M. #	Qty.	Figure #	Description	Part #	O.E.M. #	Qty.
1	Gearcase	—	6H1-45301-04-EK	1	50	Screw, Water Inlet	—	98680-05545-00	1
2	Oil Seal, Shift Shaft	18-0267	93106-09014-00	1	51	Nut, Water Inlet	—	90185-05002-00	1
3	Plate, Shift Rod	—	688-45321-00-00	1	52	Trim Tab	18-6070	988-45371-02-00	1
4	Bolt, Shift Rod Retainer	—	97395-06016-00	2	53	Bolt, Anode Mounting	—	90105-10M00-00	1
5	Washer	—	92990-06600-00	2	54	Nut, Pinion	—	90170-16M01-00	1
6	O-Ring	—	93210-49046-00	1	55	Gear, Pinion	—	688-45551-01-00	1
7	O-Ring	—	93210-07540-01	1	56	Shifter	—	6H1-45641-01-00	1
8	Circlip	—	99001-08600-00	1	57	Shift Cam	—	6H1-44151-00-00	1
9	Rod, Shift	—	6H1-44144-00-00	1	58	Shift Slide	—	6H1-45634-02-00	1
10	Circlip	—	93450-07M00-00	1	59	Pin	—	93603-12M11-00	1
11	Bearing, Pinion	—	93315-325V1-00	1	60	Nut, Spring	—	90183-02M03-00	1
12	Sleeve, Drive shaft	—	688-45536-01-00	1	61	Shift Plunger	—	6H1-45635-00-00	1
13	Shim Drive Shaft (0.10mm)	—	688-45587-01-10	AR	62	Shaft	—	6H1-45668-00-00	1
	Shim Drive Shaft (0.12mm)	—	688-45587-01-12	AR	63	Shift Plunger	—	6H1-45635-00-00	1
	Shim Drive Shaft (0.15mm)	—	688-45587-01-15	AR	64	Spring, Compression	—	90501-12M48-00	1
	Shim Drive Shaft (0.18mm)	—	688-45587-01-30	AR	65	Washer, Plate	—	90201-03313-00	1
	Shim Drive Shaft (0.30mm)	—	688-45587-01-40	AR	66	Nut, Spring	—	90183-02M03-00	1
	Shim Drive Shaft (0.40mm)	—	688-45587-01-50	AR	67	Spring, Compression	—	90501-16M65-00	1
	Shim Drive Shaft (0.50mm)	—	688-45587-01-16	AR	68	Shim Forward Gear (0.10mm)	—	688-45567-01-10	AR
14	Bearing, Upper Drive Shaft	—	93332-000U3-00	1		Shim Forward Gear (0.12mm)	—	688-45567-01-12	AR
15	Key, Impeller	18-3301	90280-04M04-00	1		Shim Forward Gear (0.15mm)	—	688-45567-01-15	AR
16	Drive Shaft	—	6H1-45501-11-00	1		Shim Forward Gear (0.18mm)	—	688-45567-01-18	AR
17	Oil Seal, Pump Base	18-0587	93101-25M03-00	2		Shim Forward Gear (0.30mm)	—	688-45567-01-30	AR
18	O-Ring, Base	18-7436	9321-46044-00	1		Shim Forward Gear (0.40mm)	—	688-45567-01-40	AR
19	Gasket, Base	18-0240	688-44316-A0-00	1		Shim Forward Gear (0.50mm)	—	688-45567-01-50	AR
20	Base, Water Pump	—	688-44341-01-94	1	69	Bearing, Forward Gear	—	93332-000W7-00	1
21	Gasket, Wear Plate to Base	—	688-44324-A0-00	1	70	Gear, Forward	—	688-45560-00-00	1
22	Wear Plate	18-3341	688-44323-00-00	1	71	Clutch, Dog	—	6H1-45631-01-00	1
23	Gasket, Wear Plate to Housing	18-0239	688-44315-A0-00	1	72	Pin, Cross	—	90250-07M02-00	1
24	Pin	—	93604-10M03-00	1	73	Spring, Cross Pin	—	688-45633-00-00	1
25	Impeller	18-3070	688-44352-03-00	1	74	Shaft, Propeller	—	6H1-45611-01-00	1
26	Insert, Water Pump	—	688-44322-00-00	1	75	Gear, Reverse	—	6H1-45571-00-00	1
27	Housing, Water Pump	18-3171	688-44311-01-00	1	76	Shim Reverse Gear (0.10mm)	—	688-45577-01-10	AR
28	Bolt, Water Pump	—	97395-08070-00	2		Shim Reverse Gear (0.12mm)	—	688-45577-01-12	AR
29	Bolt, Water Pump	—	97395-08050-00	2		Shim Reverse Gear (0.15mm)	—	688-45577-01-15	AR
30 &						Shim Reverse Gear (0.18mm)	—	688-45577-01-18	AR
31	Washer, Water Pump	—	90209-08M02-00	4		Shim Reverse Gear (0.30mm)	—	688-45577-01-30	AR
32	Nipple, Hose	—	6E5-45378-00-00	1		Shim Reverse Gear (0.40mm)	—	688-45577-01-40	AR
33	Plug, Drain	18-2371	90340-08M04-00	1		Shim Reverse Gear (0.50mm)	—	688-45577-01-50	AR
34	Gasket, Vent & Drain Plugs	18-46981-9	90430-08020-00	1	77	Washer, Thrust	—	688-45576-00-00	1
35	Plug, Drain	18-2371	90340-08M04-00	1	78	Bearing, Reverse Gear	—	93306-207U0-00	1
36	Gasket, Vent & Drain Plugs	18-46981-9	90430-08020-00	1	79	O-Ring, Bearing Housing	—	93210-85M97-00	1
37	Plug, Drain	18-2374	688-45341-00-00	1	80	Housing, Bearing	18-2782	688-45331-00-94	1
38	Gasket, Vent & Drain Plugs	18-46981-9	90430-08020-00	1	81	Key	—	90282-04010-00	1
39	Bolt	—	97395-10040-00	2	82	Bearing, Needle	—	93317-325U0-00	1
40	Washer, Lock	—	92990-10100-00	2	83	Oil Seal	18-0587	93101-25M03-00	2
41	Washer, Flat	—	92990-10600-00	2	84	Washer, Tab	—	688-45383-02-00	1
42	Bolt	—	97395-10040-00	2	85	Nut, Cover	—	688-45384-00-00	1
43	Washer, Lock	—	92990-10100-00	2	86	Spacer, Forward	—	688-45987-01-00	1
44	Washer, Flat	—	92990-10600-00	2	87	Spacer	18-4274	688-45997-01-00	1
45	Bolt	—	97395-08060-00	1	88	Washer, Propeller	—	90201-17M00-00	1
46	Washer, Lock	—	92990-08100-00	1	89	Nut, Castle	18-3732	90171-16011-00	1
47	Washer, Lock	—	92990-08100-00	1	90	Pin, Cotter	18-3735	91490-40030-00	1
48	Cover, Water Inlet (Port)	—	688-45214-02-00		91	Water Pump Repair Kit	18-3370	692-W0078-00-00	1
49	Cover, Water Inlet (Stbd)	—	688-45215-02-00	1	92	Gear Housing Seal Kit	18-2798	688-W0001-20-00	1

AR As required

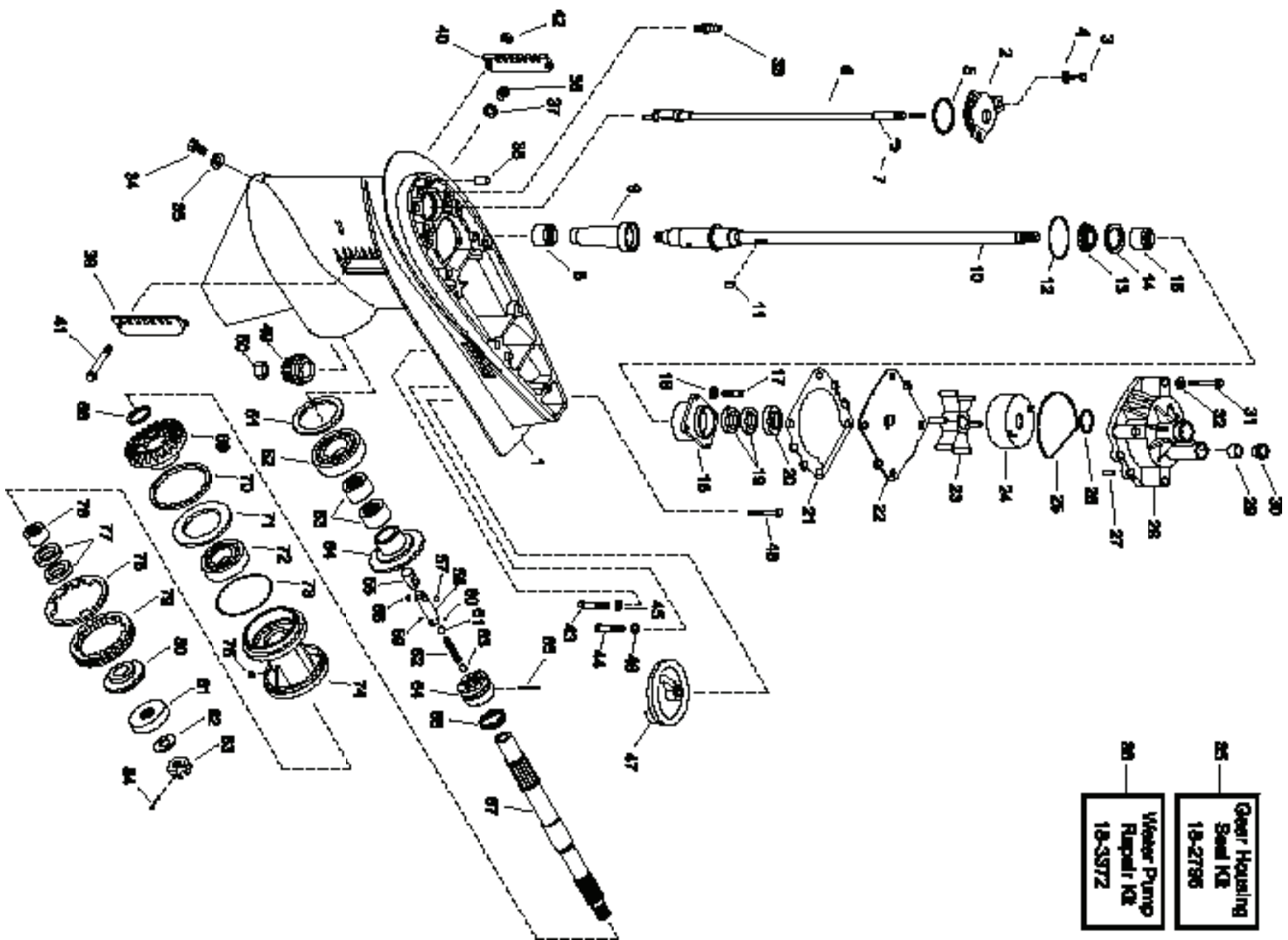
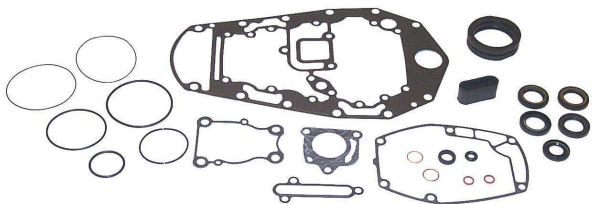

Figure #	Description	Part #	O.E.M. #	Qty.	Figure #	Description	Part #	O.E.M. #	Qty.
1	Housing, Gearcase	—	6E5-45301-03EK	1	47	Trim Tab	18-6097A	6E5-45371-01-00	1
2	Plate, Shift Rod Cover	—	6E5-45321-00-00	1	48	Bolt, Trim Tab	—	90105-10M00-00	1
3	Bolt, Shift Rod Cover	—	97395-06020-00	3	49	Gear Pinion	—	6E5-45551-02-00	1
4	Washer	—	90209-06M04-00	3	50	Nut, Pinion	—	90170-16M01-00	1
5	O-Ring, Plate	—	93210-5867-00	1	51	Shim (0.10mm)	—	6E5-45567-01-10	AR
6	Shift Rod Assembly	—	6E5-44150-01-00	1		Shim (0.12mm)	—	6E5-45567-01-12	AR
7	Circlip	—	99001-08600-00	1		Shim (0.15mm)	—	6E5-45567-01-15	AR
8	Bearing, Needle	—	93315-628U9-00	1		Shim (0.18mm)	—	6E5-45567-01-18	AR
9	Sleeve, Drive Shaft	—	6E5-45536-00-00	1		Shim (0.30mm)	—	6E5-45567-01-30	AR
10	Drive Shaft (long)	—	6E5-45501-01-00	1		Shim (0.40mm)	—	6E5-45567-01-40	AR
	Drive Shaft (x-long)	—	6E5-45501-21-00	1		Shim (0.50mm)	—	6E5-45567-01-50	AR
11	Key, Impeller	—	90280-04M05-00	1	52	Bearing, Forward Gear	—	93332-000U7-00	1
12	O-Ring, Housing	—	93210-54534-00	1	53	Bearing, Needle	—	93315-425U7-00	2
13	Bearing, Tapered	—	93341-930U0-00	1	54	Gear, Forward	—	6E5-45560-01-00	1
14	Shim (0.10mm)	—	6E5-45587-01-10	AR	55	Shifter	—	6E5-45641-01-00	1
	Shim (0.12mm)	—	6E5-45587-01-12	AR	56	Ball, Detent	—	93507-32031-00	1
	Shim (0.15mm)	—	6E5-45587-01-15	AR	57	Ball, Detent	—	93507-32031-00	1
	Shim (0.18mm)	—	6E5-45587-01-18	AR	58	Slide, Shift	—	6E5-45634-01-00	1
	Shim (0.30mm)	—	6E5-45587-01-30	AR	59	Ball, Detent	—	93503-16010-00	1
	Shim (0.40mm)	—	6E5-45587-01-40	AR	60	Ball, Detent	—	93503-16010-00	1
	Shim (0.50mm)	—	6E5-45587-01-50	AR	61	Ball, Detent	—	93511-32027-00	1
15	Bearing, Needle	—	93315-430V5-00	1	62	Spring, Compression	—	90501-16M37-00	1
16	Housing, Bearing	—	6E5-45331-0094	1	63	Ball, Detent	—	93511-32027-00	1
17	Bolt, Bearing Housing	—	97395-08025-00	4	64	Clutch, Dog	—	6R5-45631-01-00	1
18	Washer	—	92990-08600-00	4	65	Cross Pin, Clutch	—	90250-08M07-00	1
19	Seal, Drive Shaft	18-0265	93101-28M16-00	2	66	Retainer, Cross Pin	—	6E5-45631-01-00	1
20	Cover, Oil Seal	—	6E5-45344-00-00	1	67	Shaft, Propeller	18-2385	6E5-45611-01-00	1
21	Gasket, Wear Plate	18-0244	6E5-44315-A0-00	1	68	Washer, Thrust	—	90201-30M92-00	1
22	Wear Plate	18-3344	6G5-44323-00-00	1	69	Gear, Reverse	—	6E5-45571-04-00	1
23	Impeller	18-3071	6E5-44352-00-00	1	70	Shim (0.10mm)	—	6L6-45577-00-10	AR
24	Insert, Water Pump	—	6E5-44322-00-00	1		Shim (0.12mm)	—	6L6-45577-00-12	AR
25	O-Ring, Water Pump	18-7485	93210-86M38-00	1		Shim (0.15mm)	—	6L6-45577-00-15	AR
26	O-Ring, Water Pump	18-7483	93210-37M67-00	1		Shim (0.18mm)	—	6L6-45577-00-18	AR
27	Pin, Water Pump Housing	—	93606-12019-00	2		Shim (0.30mm)	—	6L6-45577-00-30	AR
28	Housing, Water Pump	18-3170	6E5-44311-00-00	1		Shim (0.40mm)	—	6L6-45577-00-40	AR
29	Damper, Water Seal	—	6E5-44365-00-00	1		Shim (0.50mm)	—	6L6-45577-00-50	AR
30	Cover, Pump Housing	—	6E5-44312-00-0	1	71	Washer, Thrust	—	6E5-45576-00-00	1
31	Bolt, Water Pump	—	97080-08045-00	4	72	Bearing, Reverse Gear	—	93306-208U0-00	1
32	Washer	—	90209-08M02-00	4	73	O-Ring, Bearing Housing	—	93210-86M39-00	1
33	Nipple, Hose	—	6E5-45378-00-00	1	74	Housing, Bearing	—	6E5-45332-00-94	1
34	Drain, Plug Lower	18-2374	688-45341-00-00	1	75	Key, Bearing Housing	—	90282-04010-00	1
35	Gasket, Drain Plug	18-4698	90430-08020-00	1	76	Bearing, Needle	—	93315-430U8-00	1
36	Drain Plug Upper	—	90340-08M04-00	1	77	Seal, Prop Shaft	18-0266	93101-30M17-00	2
37	Gasket, Drain Plug	18-4698	90430-08020-00	1	78	Washer, Tab	—	688-45383-02-00	1
38	Pin, Locating	—	93608-12M05-00	2	79	Nut, Cover	—	688-45384-00-00	1
39	Cover, Water Inlet (Port)	—	688-45214-02-00	1	80	Washer, Thrust	—	6E5-45987-01-00	1
40	Cover, Water Inlet (Stbd)	—	688-45215-02-00	1	81	Spacer, Prop	18-4274	688-45997-01-00	1
41	Screw, Water Inlet	—	90142-05M03-00	1	82	Washer, Prop	—	92990-18200-00	1
42	Nut, Water Inlet	—	90185-05002-00	1	83	Nut, Prop	18-3726	90171-18M04-00	1
43	Bolt	—	97395-10070-00	1	84	Pin, Cotter	18-3735	91490-40030-00	1
44	Bolt	—	97395-10070-00	1	85	Gear Housing Seal Kit	18-2796	6E5-W0001-51-00	1
45	Washer	—	92990-10100-00	1	86	Water Pump Repair Kit	18-3372	6E5-W0078-00-00	1
46	Washer	—	92990-10100-00	1					

AR As required

Figure #	Description	Part #	O.E.M. #	Qty.	Figure #	Description	Part #	O.E.M. #	Qty.
1	Housing, Gearcase	—	6J9-45301-02-EK	1	49	Bolt	—	97395-10070-00	1
2	Plate, Shift Rod Cover	—	6E5-45321-00-00	1	50	Washer	—	92990-10100-00	1
3	Bolt, Shift Rod Cover	—	97395-06020-00	3	51	Washer	—	92990-10100-00	1
4	Washer	—	90209-06M04-00	3	52	Trim Tab	18-6035	6J9-45371-01-00	1
5	O-Ring, Plate	—	93210-58677-00	1	53	Bolt, Trim Tab	—	90105-10M00-00	1
6	Shift Rod Assembly	—	6G5-44150-01-00	1	54	Gear Pinion	—	6G5-45551-01-00	1
7	Circlip	—	99001-08600-00	1	55	Nut, Pinion	—	90170-16M01-00	1
8	Bearing, Needle	—	90250-08M07-00	1	56	Shim (0.10mm)	—	6G5-45567-01-10	AR
9	Sleeve, Drive Shaft	—	6G5-45536-01-00	1		Shim (0.12mm)	—	6G5-45567-01-12	AR
10	Washer	—	90209-33M13-00	1		Shim (0.15mm)	—	6G5-45567-01-15	AR
11	Spring, Compression	—	90501-05M64-00	AR		Shim (0.18mm)	—	6G5-45567-01-30	AR
12	Collar	—	90387-33M00-00	1		Shim (0.30mm)	—	6G5-45567-01-40	AR
13	Washer	—	90209-33M13-00	1		Shim (0.40mm)	—	6G5-45567-01-50	AR
14	Washer	—	90209-33M12-00	1		Shim (0.50mm)	—	6G5-45567-01-10	AR
15	Drive Shaft (long)	—	6G5-45501-01-00	1	57	Bearing, Forward Gear	—	93332-00V3-00	1
	Drive Shaft (x-long)	—	6G5-45501-21-00	1	58	Bearing, Needle	—	93315-425V3-00	2
16	Key, Impeller	—	90280-04M05-00	1	59	Gear, Forward	—	6G5-45631-00-00	1
17	O-Ring, Housing	—	93210-54534-00	1	60	Shifter	—	6E5-45641-01-00	1
18	Bearing, Tapered	—	93341-930U0-00	1	61	Ball, Detent	—	93507-32031-00	1
19	Shim (0.10mm)	—	6E5-45587-01-10	AR	62	Ball, Detent	—	93507-32031-00	1
	Shim (0.12mm)	—	6E5-45587-01-12	AR	63	Slide, Shift	—	6E5-45634-01-00	1
	Shim (0.15mm)	—	6E5-45587-01-15	AR	64	Ball, Detent	—	93503-16010-00	1
	Shim (0.18mm)	—	6E5-45587- 01-18	AR	65	Ball, Detent	—	93503-16010-00	1
	Shim (0.30mm)	—	6E5-45587-01-30	AR	66	Ball, Detent	—	93511-32027-00	1
	Shim (0.40mm)	—	6E5-45587-01-40	AR	67	Spring, Compression	—	90501-16M37-00	1
	Shim (0.50mm)	—	6E5-45587-01-50	AR	68	Ball, Detent	—	93511-32027-00	1
20	Bearing, Needle	—	93315-430V5-00	1	69	Clutch, Dog	—	6E5-45633-01-00	1
21	Housing, Bearing	—	6E5-45331-00-94	1	70	Cross Pin, Clutch	—	90250-08M07-00	1
22	Bolt, Bearing Housing	—	97395-08025-00	4	71	Retainer, Cross Pin	—	6E5-45633-01-00	1
23	Washer	—	92990-08600-00	4	72	Shaft, Propeller	—	6J9-45611-01-00	1
24	Seal, Drive Shaft	18-0265	93101-28M16-00	2	73	Washer, Thrust	—	90201-30M92-00	1
25	Cover, Oil Seal	—	6E5-45344-00-00	1	74	Gear, Reverse	—	6G5-45571-02-00	1
26	Gasket, Wear Plate	18-0244	6E5-44315-A0-00	1	75	Shim (0.10mm)	—	6G5-45577-02-10	AR
27	Wear Plate	18-3345	6G5-44323-00-00	1		Shim (0.12mm)	—	6G5-45577-02-12	AR
28	Impeller	18-3071	6E5-44352-00-00	1		Shim (0.15mm)	—	6G5-45577-02-15	AR
29	Insert, Water Pump	—	6E5-44322-00-00	1		Shim (0.18mm)	—	6G5-45577-02-18	AR
30	O-Ring, Water Pump	18-7485	93210-86M38-00	1		Shim (0.30mm)	—	6G5-45577-02-30	AR
31	O-Ring, Water Pump	18-7483	93210-37M67-00	1		Shim (0.40mm)	—	6G5-45577-02-40	AR
32	Pin, Water Pump Housing	—	93606-12019-00	2		Shim (0.50mm)	—	6G5-45577-02-50	AR
33	Housing, Water Pump	18-3170	6E5-44311-00-00	1	76	Washer, Thrust	—	6G5-45576-00-00	1
34	Damper, Water Seal	—	6E5-44365-00-00	1	77	Bearing, Reverse Gear	—	93306-209U0-00	1
35	Cover, Pump Housing	—	6E5-44312-00-00	1	78	O-Ring, Bearing Housing	18-0275	93210-97M55-00	1
36	Bolt, Water Pump	—	97080-08045-00	4	79	Bearing Housing Assembly	—	6J9-45332-00-94	1
37	Washer	—	90209-08M02-00	4	80	Key, Bearing Housing	—	90282-04010-00	1
38	Nipple, Hose	—	6E5-45378-00-00	1	81	Bearing, Needle	—	93315-430U8-00	1
39	Drain, Plug Lower	18-2374	688-45341-00-00	1	82	Seal, Prop Shaft	18-0266	93101-30M17-00	2
40	Gasket, Drain Plugs	—	90430-08020-00	2	83	Washer, Tab	—	9G5-45383-01-00	1
41	Drain Plug Upper	—	90340-08M04-00	1	84	Nut, Cover	—	6G5-45384-00-00	1
42	Gasket, Drain Plugs	—	90430-08020-00	2	85	Washer, Thrust	—	6E5-45987-00-00	1
43	Pin, Locating	—	93608-12M05-00	2	86	Spacer, Prop	18-4274	688-45997-01-00	1
44	Cover, Water Inlet (Port)	—	6J9-45214-00-00	1	87	Washer, Prop	—	92990-18200-00	1
45	Cover, Water Inlet (Stbd)	—	6J9-45215-00-00	1	88	Nut, Prop	18-3726	90171-18M04-00	1
46	Screw, Water Inlet	—	90142-05M04-00	1	89	Pin, Cotter	18-3735	91490-40030-00	1
47	Nut, Water Inlet	—	90185-05002-00	1	90	Gear Housing Seal Kit	18-2794-1	6G5-W0001-21-00	1
48	Bolt	—	97395-10070-00	1	91	Water Pump Repair Kit	18-3311	6G5-W0078-00-00	1

AR As required



18-0020
GEAR HOUSING SEAL KIT

Replaces: 67C-W0001-21-00
For: T25 (2001-02) / F30 (2002) F40 (2002) 3 cyl model

— CONTAINS —

Part #	Desc.	O.E.#	Qty.
18-0296	Seal, Propshaft	93101-22067	2
18-4698	Drain Fill Washer	90430-08020-00	2
18-4698	Drain Fill Washer	604-45342-00-00	2
18-4698	Drain Fill Washer	90430-08020-00	2

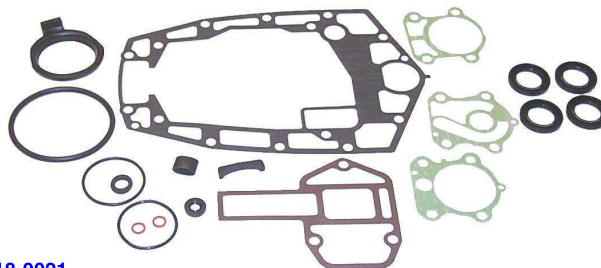

18-0021
GEAR HOUSING SEAL KIT

Replaces: 688-W0001-22-00
For: C75 (1994-99) / E75 (1995-00) / P75 (1996-99)
C80 (1997) / C85 (1992-96) / 90 (1992-02) B90(1998-99) / C90 (1997-01)

— CONTAINS —

Part #	Desc.	O.E.#	Qty.
18-0239	Gasket	688-44315-A0	1
18-0240	Gasket	688-44316-A0	1
18-7436	O-Ring	93210-46044-00-00	2
18-0267	Oil Seal	93106-09014	1
18-0587	Oil Seal	93101-25M03	4
18-4698	Plug, Drain	90430-08020	2

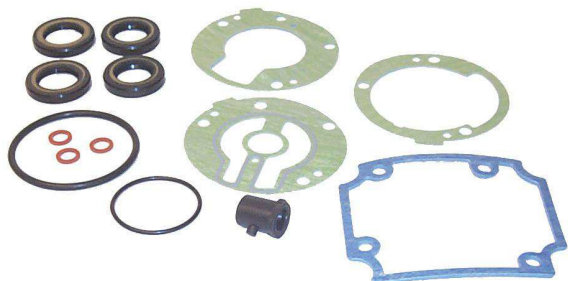

18-0022
GEAR HOUSING SEAL KIT

Replaces: 689-W0001-23-00
For: C25 (1992-97) / C30 (1992)

— CONTAINS —

Part #	Desc.	O.E.#	Qty.
18-99010	Exhaust Manifold Gasket	664-41134-A0-00	1
18-0296	Seal, Propshaft	93101-22067	2
18-0554	Seal	93101-20M07	2
18-0773	Gasket	689-44316-A0	1
18-4698	Plug, Drain	90430-08020	3



18-0023
GEAR HOUSING SEAL KIT

Replaces: 689-W0001-C2-00
For: C25 (1986-87) C25 (1990-91) 30 (1986) C30 (1990-91)

— CONTAINS —

Part #	Desc.	O.E.#	Qty.
18-99010	Exhaust Manifold Gasket	664-41134-A0-00	1
18-0554	Seal	93101-20M07	2
18-4698	Plug, Drain	90430-08020	3

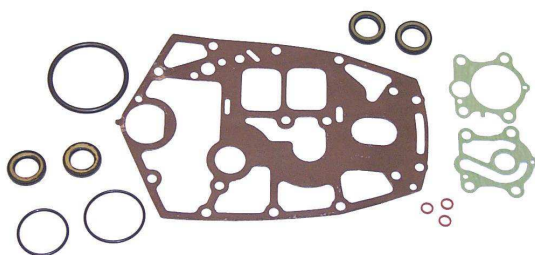

18-0024
GEAR HOUSING SEAL KIT

Replaces: 698-W0001-21-00
For: E48 (1995-00) / C55 (1989-94)

— CONTAINS —

Part #	Desc.	O.E.#	Qty.
18-0292	Gasket	663-44315-A0	1
18-0294	Gasket	663-44324-A0	1
18-0297	Seal, Drive Shaft	93101-23070	2
18-0296	Seal, Propshaft	93101-22067	2
18-0298	O-Ring	93210-41042	1
18-7160	O-Ring	93210-66M98	1
18-4698	Plug, Drain	90430-08020	3

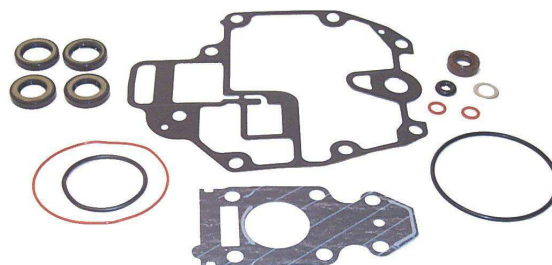

18-0025
GEAR HOUSING SEAL KIT

Replaces: 69G-W0001-20-00
For: T8 (2001-04)

— CONTAINS —

Part #	Desc.	O.E.#	Qty.
18-7442	O-Ring	93210-74M68	1
18-4698	Plug, Drain	90430-08020	2



18-0026
GEAR HOUSING SEAL KIT
Replaces: 6A1-W0001-22-00
For: 2HP (1986-88)

— CONTAINS —

Part #	Desc.	O.E.#	Qty.
18-4698	Plug, Drain	90430-08020	2



18-0027
GEAR HOUSING SEAL KIT
Replaces: 6A1-W0001-23-00
For: 2HP (1989-02)

— CONTAINS —

Part #	Desc.	O.E.#	Qty.
18-4698	Plug, Drain	90430-08020	2



18-0028
GEAR HOUSING SEAL KIT
Replaces: 6E0-W0001-C1-00
For: 4HP (1984-99) / F4 (1999-02) / 5HP (1984-02)

— CONTAINS —

Part #	Desc.	O.E.#	Qty.
18-4698	Plug, Drain	90430-08020	3



18-0029
GEAR HOUSING SEAL KIT
Replaces: 6G1-W0001-C1-00
For: 6HP (1986-96) 8HP (1984-96)

— CONTAINS —

Part #	Desc.	O.E.#	Qty.
18-4698	Plug, Drain	90430-08020	3



18-0030
GEAR HOUSING SEAL KIT
Replaces: 6L2-W0001-C3-00
For: 20HP (1996-97) 25HP (1988-02) 2 cyl model

— CONTAINS —

Part #	Desc.	O.E.#	Qty.
18-0554	Seal	93101-20M07	2
18-4698	Plug, Drain	90430-08020	2



18-0031
GEAR HOUSING SEAL KIT
Replaces: 6N0-W0001-C0-00
For: 6HP (1997-00), 8HP (1997-04)

— CONTAINS —

Part #	Desc.	O.E.#	Qty.
18-4698	Plug, Drain	90430-08020	3



18-2785
GEAR HOUSING SEAL KIT
Replaces: 689-W0001-21-00, 689-W0001-C1-00

— CONTAINS —

Part #	Desc.	O.E.#	Qty.
18-0776	Grommet	682-44365-00-00	1
18-0552	Grommet	689-44366-00-00	1
18-4698	Drain or Fill Washer Gasket	YSG-14090-90-8G	3
18-0554	Oil Seal	93101-20M07-00	1
18-0296	Oil Seal	93101-22067-00	2
18-7405	O-Ring	93210-40M10-00	1
18-0766	Exhaust Tube Gasket	664-41134-A0-00	1
18-0773	Wear Plate Gasket	689-44316-A0-00	1

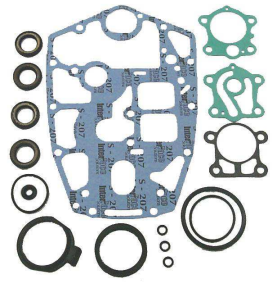

18-2787
GEAR HOUSING SEAL KIT
Replaces: 698-W0001-20-00, 698-W0001-C0-00

— CONTAINS —

Part #	Desc.	O.E.#	Qty.
18-4698	Drain or Fill Washer Gasket	YSG-14090-90-8G	3
18-0296	Oil Seal	93101-22067-00	2
18-0297	Oil Seal	93101-23070-00	2
18-0298	O-Ring	93210-41042-00	1
18-0299	O-Ring	93210-66M98-00	1
18-0292	Wear Plate to Pump Housing Gasket	663-44315-A0-00	1
18-0267	Oil Seal	93106-09014-00	1
18-0294	Wear Plate to Pump Base Gasket	663-44324-A0-00	1

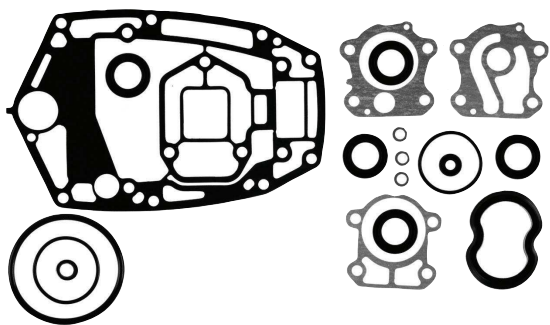

18-2788

LOWER UNIT SEAL KIT

Replaces: 6H3-W0001-21-00, 6H3-W0001-C1-00

— CONTAINS —

Part #	Desc.	O.E. #	Qty.
18-0240	Wear Plate to Gear Case Mounting Gasket	688-44316-A0-00	1
18-0756-1	Water Pump Gasket	6H3-44315-A0-00	1
18-0757	Outer Plate Gasket	6H3-44324-A0-00	1
18-4698	Drain or Fill Washer	YSG-14090-90-8G	3
18-0297	Oil Seal	93101-23070-00	2
18-0267	Oil Seal	93106-09014-00	1
18-7436	O-Ring	93210-46044-00	1

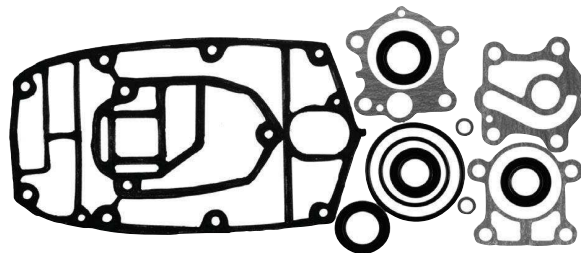

18-2789

LOWER UNIT SEAL KIT

Replaces: 6J8-W0001-21-00, 6J8-W0001-C2-00

— CONTAINS —

Part #	Desc.	O.E. #	Qty.
18-0292	Wear Plate to Pump Housing Gasket	663-44315-A0-00	1
18-0294	Wear Plate to Pump Base Gasket	663-44324-A0-00	1
18-4698	Drain or Fill Washer	YSG-14090-90-8G	2
18-0554	Oil Seal	93101-20M07-00	2
18-0297	Oil Seal	93101-23070-00	2
18-0298	O-Ring	93210-41042-00	1

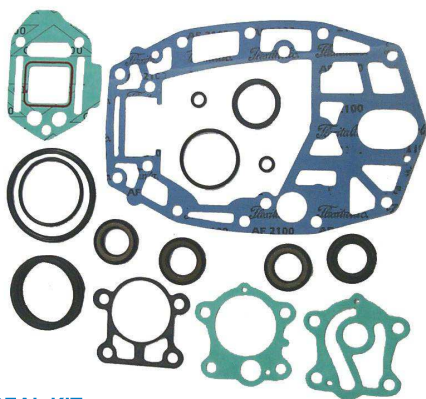

18-2792

LOWER UNIT SEAL KIT

Replaces: 6H4-W0001-21-00, 6H4-W0001-20-00

— CONTAINS —

Part #	Desc.	O.E. #	Qty.
18-0292	Wear Plate to Pump Housing Gasket	663-44315-A0-00	1
18-0294	Wear Plate to Pump Base Gasket	663-44324-A0-00	1
18-4698	Drain or Fill Washer Gasket	YSG-14090-90-8G	2
18-0296	Oil Seal	93101-22067-00	2
18-0297	Oil Seal	93101-23070-00	2
18-0298	O-Ring	93210-41042-00	1
18-0299	O-Ring	93210-66M98-00	1
18-0293	Pump Base to Gearcase Gasket	663-44316-A0-00	1

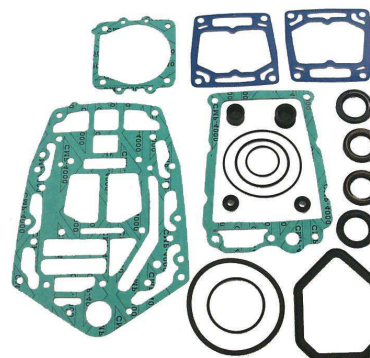

18-2794-1

LOWER UNIT SEAL KIT

Replaces: 6F3-W0001-21-00, 6F3-W0001-C1-00
6E5-W0001-51-00, 6E5-W0001-F1-00
6G5-W0001-21-00, 6G5-W0001-C1-00

— CONTAINS —

Part #	Desc.	O.E. #	Qty.
18-0244	Water Pump Gasket	6E5-44315-A0-00	1
18-4698	Drain or Fill Washer Gasket	YSG-14090-90-8G	2
18-0265	Oil Seal	93101-28M16-00	2
18-0266	Oil Seal	93101-30M17-00	2
18-0267	Oil Seal	93106-09014-00	1
18-7483	O-Ring	93210-37M67-00	1
18-7485	O-Ring	93210-86M38-00	1
18-0275	O-Ring	93210-97M55-00	1

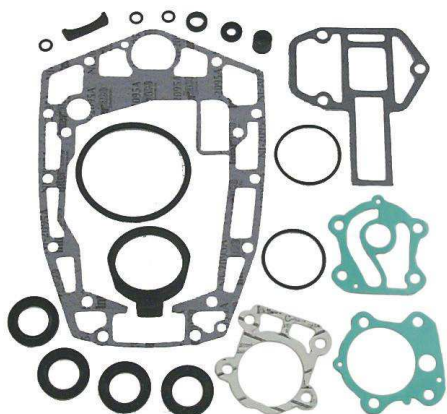

18-2798

LOWER UNIT SEAL KIT

Replaces: 688-W0001-20-00, 688-W0001-C0-00

— CONTAINS —

Part #	Desc.	O.E. #	Qty.
18-0240	Wear Plate to Gear Case Mounting Gasket	688-44316-A0-00	1
18-4698	Drain or Fill Washer Gasket	YSG-14040-90-8G	3
18-7436	O-Ring	93210-46044-00	1
18-0239	Wear Plate to Pump Housing Gasket	688-44315-A0-00	1
18-0267	Oil Seal	93106-09014-00	1

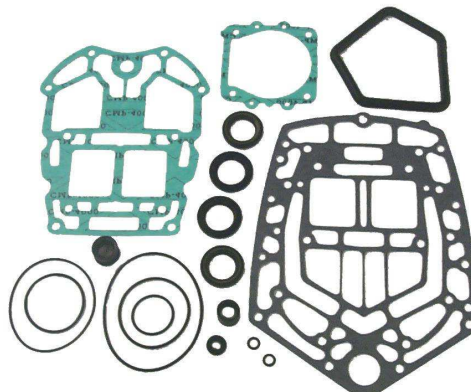

18-2799

LOWER UNIT SEAL KIT

Replaces: 61A-W0001-21-00, 61A-W0001-C1-00

— CONTAINS —

Part #	Desc.	O.E. #	Qty.
18-0244	Water Pump Gasket	6E5-44315-A0-00	1
18-4698	Drain or Fill Washer Gasket	YSG-14040-90-8G	2
18-0265	Oil Seal	93101-28M16-00	2
18-0266	Oil Seal	93101-30M17-00	1
18-0267	Oil Seal	93106-09014-00	1
18-7483	O-Ring	93210-37M67-00	1
18-7485	O-Ring	93210-86M38-00	1
18-7444	O-Ring	93210-04384-00	1



18-74501
GEAR HOUSING SEAL KIT
 Replaces: 683-W0001-C1-00
 Fits: Yamaha 9.9/15(1984-91)



18-74504
GEAR HOUSING SEAL KIT
 Replaces: 6H3-W0001-22-00
 Fits: Yamaha 60(2002), C60(1996-01), E60(1995-00), P60(1992-99), 70(1992-02)



18-74507
GEAR HOUSING SEAL KIT
 Replaces: 63V-W0001-21-00
 Fits: Yamaha 9.9(1997-00), 15(1997-00)



18-74510
GEAR HOUSING SEAL KIT
 Replaces: 65L-W0001-C0-00
 Fits: Yamaha 225/L225(1997-99), 3.1L, 250/L250(1997-99), SX225/SX250(2000-02), LX225/LX250(2000-02)



18-74512
GEAR HOUSING SEAL KIT
 Replaces: 66K-W0001-20-00
 Fits: Yamaha V200/V225(1998-99), VX200/VX225(2000-02), VX250(2002)



18-74515
GEAR HOUSING SEAL KIT
 Replaces: 68V-W0001-20-00
 Fits: Yamaha F115/LF115(2000-05)



18-74527
GEAR HOUSING SEAL KIT
 Replaces: 6G9-W0001-C6-00
 Fits: Yamaha F9.9(1997-05)



18-74535
GEAR HOUSING SEAL KIT
 Replaces: 67F-W0001-20-00
 Fits: Yamaha F75/F90(2003-05), F80/F100(1999-02)



18-74540
SEAL KIT
 Replaces: 62Y-W0001-20-00
 Fits: Yamaha F40 4cyl(1999), F50(1995-00)



18-74544
GEAR HOUSING SEAL KIT
 Replaces: 68T-W0001-20-00
 Fits: Yamaha F6/F8(2001-03)



18-74546
GEAR HOUSING SEAL KIT
 Fits: Yamaha T40/T30 Enduro International Series

GEAR HOUSING SEAL KIT APPLICATION

Model #	Year	Lower Unit Gasket Kit	Model #	Year	Lower Unit Gasket Kit	Model #	Year	Lower Unit Gasket Kit
2	1986-88	18-0026	C55	1992-95	18-0024	SX150	1999-04	18-2794-1
2	1989-02	18-0027	CV55	1989-90	18-2787	V150	2000-08	18-2794-1
4	1984-99	18-0028	P60	1991	18-2788	VX150	2000-04	18-2794-1
F4	1999-08	18-0028	70	1984-85, 1988-91	18-2788	VZ150	2000-11	18-2794-1
5	1984-02	18-0028	C75	1994-99	18-0021	175	1984-00	18-2794-1
6	1988-96	18-0029	E75	1995-00	18-0021	P175	1994-99	18-2794-1
6	1997-00	18-0031	P75	1996-99	18-0021	S175	1996-99	18-2794-1
8	1984-96	18-0029	C80	1997	18-0021	V175	2000	18-2794-1
8	1997-09	18-0031	C85	1991	18-2798	VZ175	2001-11	18-2794-1
T8	2001-10	18-0025	C85	1992-96	18-0021	Z175	2001-05	18-2794-1
20	1996-97	18-0030	CV85	1989-90	18-2798	200	1984-98	18-2794-1
25 ①	1984-85	18-2785	90	1984-91	18-2798	L200	1986-99	18-2794-1
25 ①	1986-87	18-0023	90	1992-09	18-0021	LX200	1999-01	18-2794-1
25 ①	1988-09	18-0030	B90	1997-99	18-0021	LZ200	2000-11	18-2794-1
25 ②	1997-02	18-2789	C90	1997-	18-0021	P200	1991-99	18-2794-1
C25	1991	18-0023	115	1986-09	18-2794-1	S200	1996-99	18-2794-1
C25 ①	1992-97	18-0022	C115	1992-00	18-2794-1	SX200	1999-05	18-2794-1
CV25	1990	18-0023	P115	1993-96	18-2794-1	VZ200	2001-04	18-2794-1
T25 ①	2002	18-0020	S115	1996-99	18-2794-1	Z200	2000-11	18-2794-1
30	1984-85	18-2785	130	1988-04	18-2794-1	V6 Special	1984-86	18-2794-1
30	1986	18-0023	L130	1989-01	18-2794-1	V6 Excel	1987-89	18-2794-1
30	1987-02	18-2789	S130	1996-99	18-2794-1	225 ③	1990-97	18-2794-1
C30	1991	18-0023	150	1984-09	18-2794-1	225 ④	1994-96	18-2799
C30	1992	18-0022	C150	1996-99	18-2794-1	L225 ④	1994-96	18-2799
F30 ②	2002	18-0020	L150	1986-99	18-2794-1	S225	1996	18-2799
40	1984-94	18-2792	LX150	1999-01	18-2794-1	250	1990-95	18-2799
C40	1992-94	18-99104	LZ150	2000-05	18-2794-1	L250	1990-96	18-2799
F40 ②	2002	18-0020	Z150	2000-05	18-2794-1	S250	1996	18-2799
50	1986-94	18-2792	P150	1991-99	18-2794-1			
PRO 50	1987-90	18-2792	PX150	1999	18-2794-1			
P50	1992-94	18-2792	PRO V150	1987-90	18-2794-1			
C55	1991	18-2787	S150	1996-99	18-2794-1			

① 2 cylinder model

② 3 cylinder model

③ 2.6 liter engine

④ 3.1 liter engine



OIL SEALS

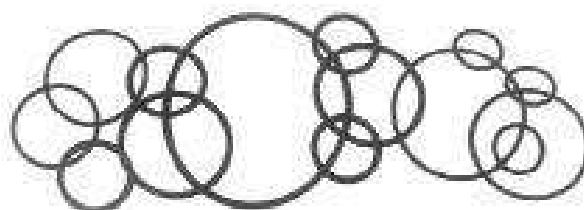

O-RINGS

Part #	OE#	Dimensions			Part #	Std. Pkg.	O.E.#	Part #	Std. Pkg.	O.E.#
		I.D.	O.D.	Width						
18-0265	93101-28M16-00	27	43.25	7	18-0275	1	93210-97M55-00	18-7470	1	65W-43865-00-00
18-0266	93101-30M17-00	28.5	45.25	7	18-0298	1	93210-41042-00	18-7471	1	93210-94003-00
18-0267	93106-09014-00	8.75	19.2	5.25	18-0299	1	93210-66M98-00	18-7483	1	93210-37M67-00
18-0296	93101-22067-00	23	36.25	6	18-7119	1	93210-33M85-00	18-7485	1	93210-86M38-00
18-0297	93101-23070-00	22.75	37.25	6	18-7432 ⑤	2	93210-32738-00	18-7511-9	5	93210-16716-00
18-0554	93101-20M07-00	21.5	34	6.25	18-7436	1	93210-46044-00	18-76689	1	65W-14198-00-00
18-0570	93102-23096-00	22.75	38.25	7	18-7439-9	5	93210-54M54-00	18-76690	1	93210-46M16-00
18-0587	93101-25M03-00	24	40.25	6	18-7442	1	93210-74M35-00	18-76691	1	93210-27ME3-00
18-0588	93102-25M28-00	24.5	48.4	8	18-7444	1	93211-04384-00	18-76692	1	93210-75M51-00
18-2079	93101-22M15-00	21.75	35.2	6	18-7463	1	93210-19123-00	18-76693	1	93210-31MJ5-00
18-2085	93102-35M13-00	34	52.25	8	18-7468	1	6G5-43864-00-00	18-76694	1	93210-24M79
18-2087	93102-40M36-00	39.5	58.25	8.5	18-7469	1	64E-43869-00-00			
18-2091	93104-22M07-00	22	29.25	5						

⑤ This product is priced per piece. To order priced per package, please add -9 to the part number.