



23-1100
AIR FILTER

Replaces: Kohler 267709
Fits: 3.5 CFZ, 4 CZ, 5 CFZ, 6.5 CZ



23-1101
AIR FILTER

Replaces: Westerbeke 39705
Fits: 8.0 BTDA(60Hz) / 6.0 BTDA(50Hz), 10.0 BTDA(60Hz) / 7.5 BTDA(50Hz), 12.5 BTDB(60Hz) / 9.4 BTDB(50Hz), 15.0 BTDC(60Hz) / 12.0 BTDC(50Hz)



23-1104
AIR FILTER

Replaces: Fischer Panda IC78.460.000B
Fits: PMS 4200, PMS04, PMS15, PMS 16 DP, PMS 20, PMS 22

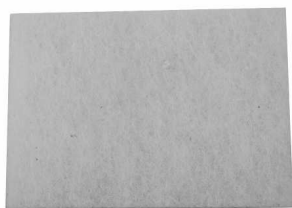

23-1105
AIR FILTER

Replaces: Fischer Panda IC78.460.000A
Fits: PMS 8 Mini, PMS 8 DP, PMS 6500, PMS 12 DP, PMS 12 Mini



23-1102
AIR FILTER ELEMENT

Replaces: Northern Lights 24-22009
Fits: M843NW3: 12/10Kw, M844W3: 16/12KW, M844LW3: 20/16Kw



23-1103
AIR FILTER ELEMENT

Replaces: Northern Lights 24-28003
Fits: M673LD3: 5 / 4.5Kw, M673L3: 6/5Kw

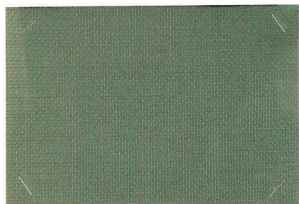

23-1130
AIR FILTER

Replaces: Kohler 278857
Fits: 4 CCFOZ(variation 4), 4EFOZ(variation 4), 5 CCOZ(variation 4), 5EOZ(variation 4), 6.5 EFOZ(variation 4), 8EOZ(variation 4), 8EFOZ, 9 CCOZ, 9EOZ, 9EFOZ, 10EOZ, 6.5EFOZD, 7 EFOZD, 8EOZD, 8.5 EFOZD, 9 EOZD, 9EFOZD, 10EOZD



23-7200
CARB KIT

Replaces: Westerbeke 36450
Fits: 6.5 TWG(60Hz)/4.9 TWG(50Hz), 8.0 TWG(60Hz)/6.4 TWG(50Hz), 8.5 BTG(60Hz)/6.5 BTG(50Hz), 12.5 BTG(60Hz)/10.0 BTG(50Hz), 15.0 BTG/A(60Hz)/12.0 BTG/A(50Hz), 20.0 BEG(60Hz)/16.0 BEG(50Hz), 25.0 BEG(60Hz)/20.0 BEG(50Hz)

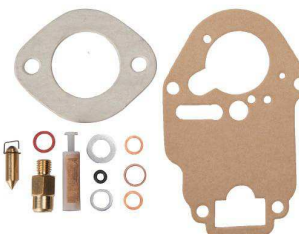

23-7201
CARB KIT

Replaces: Westerbeke 38100
Fits: 4.0 BCG(60Hz)/3.0 BCG(50Hz), 4.5 BCG(60Hz)/3.75 BCG(50Hz), 4.5 BCGTC(60Hz)/3.75 BCGTC(50Hz), 5.0 BCG(60Hz)/4.2 BCG(50Hz), 6.5 BCG(60Hz)/4.8 BCG(50Hz), 7.0 BCG(60Hz)/5.0 BCG(50Hz), 7.0 BCGA(60Hz)/5.0 BCGA(50Hz), 7.0 BCGB(60Hz)/6.0 BCGB(50Hz), 7.2 BCGTC(60Hz)/6.0 BCGTC(50Hz), 8.0 BEG(60Hz)/6.4 BEG(50Hz), 9.6 BCGTC(60Hz)/8.0 BCGTC(50Hz), 10.0 BEG(60Hz)/8.0 BEG(50Hz), 12.5 BEG(60Hz)/10.0 BEG(50Hz), 15.0 BEG(60Hz)/12.0 BEG(50Hz)

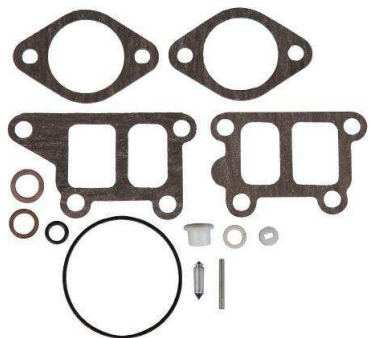

23-7202
CARB KIT

Replaces: Kohler GM24510
Fits: 4EF, 5E, 6EF, 7.3E, 5ECD, 4EFCD, 6EFCD and 7.3 ECD



23-7740
FUEL FILTER

Replaces: Kohler 252898
Fits: 11 CCFOZ (variation 2), 11.5 CCFOZ (variation 2), 11EFOZ (variation 2), 11.5EFOZ (variation 2), 13EOZ (variation 2), 13EFOZ (variation 2), 13.5 CCOZ (variation 2), 14 CCOZ (variation 2), 14EOZ (variation 2), 15 CCFOZ (variation 3), 15.5EOZ (variation 2), 16EFOZ (variation 3), 17.5EFOZ (variation 3), 18.5 CCOZ (variation 3), 19EFOZ (variation 3), 20 CCFOZ (variation 3), 20EOZ (variation 3), 20EFOZ (variation 3), 23EOZ (variation 3), 24 CCOZ (variation 3), 24EOZ (variation 3), 17EFOZD (variation 3), 17.5EFOZD (variation 3), 19EFOZD (variation 3), 20EOZD (variation 3), 20EFOZD (variation 3), 23EOZD (variation 3), 24EOZD (variation 3)



23-7751
FUEL FILTER

Replaces: Kohler 229715
Fits: 4 CCFOZ, 4EFOZ, 5 CCOZ, 5EOZ, 6.5 EFOZ, 8EOZ, 6.5EFOZD, 8EOZD



**23-7760
FUEL FILTER**

Replaces: Onan A026K278, 149-2106
Fits: MDKAU, MDKAV, MDKBG, MDKAW (Spacesaver), MDKAZ, MDKBD, MDKBE, MDKBF, MDKBD (w/ Isolated Ground), MDKBE (w/ Isolated Ground), MDKBF (w/ Isolated Ground), MDKAD/E/F



**23-7761
FUEL FILTER**

Replaces: Kohler GM32359
Fits: 7 EFOZD(variation 1), 8.5 EFOZD(variation 1), 9 EOZD(variation 1), 9EFOZD(variation 1), 10EOZD(variation 1), 11EFOZD(variation 3), 11.5EFOZD(variation 3), 13EFOZD(variation 3), 14 EOZD(variation 3), 15.5 EOZD(variation 3), 17 EFOZD(variation 1), 17.5EFOZD(variation 1), 19EFOZD(variation 1), 20EOZD(variation 1), 20EFOZD(variation 1), 23EOZD(variation 1), 24EOZD(variation 1), 23EFOZD, 27EFOZD, 28EOZD, 32EOZD



**23-7762
FUEL FILTER**

Replaces: Kohler 267987
Fits: 4EF, 5E, 6EF, 7.3E, 8E (GR4 Version), 10E (GR4 Version), 12.5E (GR4 Version)



**23-7764
FUEL FILTER**

Replaces: Westerbeke 24363
Fits: 15.0 BTD(60Hz) / 12.0 BTD(50Hz), 15.0 BTDA(60Hz) / 12.0 BTDA(50Hz), 15.0 BTDB(60Hz) / 12.0 BTDB(50Hz), 15.0 WTA(60Hz) / 12.0 WTA(50Hz), 20.0 BED(60Hz) / 16.0 BED(50Hz), 20.0 BEDA(60Hz) / 16.0 BEDA(50Hz), 20.0 WTA(60Hz) / 16.0 WTA(50Hz), 25.0 BED(60Hz) / 20.0 BED(50Hz), 25.0 WTA(60Hz) / 20.0 WTA(50Hz), 32.0 BED(60Hz) / 25.0 BED(50Hz), 32.0 BEDB(60Hz) / 25.0 BEDB(50Hz), 32.0 WTF(60Hz) / 25.0 WTF(50Hz)



**23-7780
FUEL FILTER**

Replaces: Kohler GM34570
Fits: 9 EFGD, 10 EG, 10 EGD, 13 EG, 13 EGD, 13 EGZ, 15 EG, 15 EGD, 15 EGZ



**23-7750
FUEL FILTER ELEMENT**

Replaces: Onan 149-0428
Fits: MDJA (Spec A-R), MDJB (Spec A-R), MDJC (Spec A-R), MDJE (Spec A), MDJF (Spec A)



**23-7720
FUEL FILTER KIT**

Replaces: Westerbeke 35920
Onan 149-1445
Fits: Westerbeke: 4.0 BCG(60Hz)/3.0 BCG(50Hz), 6.5 BCG(60Hz)/4.8 BCG(50Hz), 6.5 TWG(60Hz)/4.9 TWG(50Hz), 8.0 TWG(60Hz)/6.4 TWG(50Hz), 9.0 BTG(60Hz)/7.0 BTG(50Hz), 11.0 TWG(60Hz)/8.5 TWG(50Hz)



**23-7770
FUEL FILTER KIT**

Replaces: Westerbeke 47006, 30200
Fits several models. See application chart on pages 120-131



**23-7771
FUEL FILTER KIT**

Replaces: Kohler 249433
Fits: 3.5 CFZ(Variation 2), 4 CZ(Variation 2), 5 CFZ(Variation 2), 6.5 CZ(Variation 2), 8E(Variation 2), 10E(Variation 2), 12.5E(Variation 2)



**23-1000
GLOW PLUG (12 Volt)**

Replaces: Westerbeke 24353
Fits: 4.4 BCD(60Hz), 4.4 WMD(60Hz) / 3.3 WMD(50Hz), 6.0 BCD(60Hz) / 4.5 BCD(50Hz), 7.7 WMD(60Hz) / 5.8 WMD(50Hz), 8.0 BTD(60Hz) / 6.0 BTD(50Hz), 8.0 BTDA(60Hz) / 6.0 BTDA(50Hz), 8.0 WMD(60Hz) / 6.0 WMD(50Hz), 10.0 BTD(60Hz) / 7.5 BTD(50Hz), 10.0 BTDA(60Hz) / 7.5 BTDA(50Hz), 11.0 BTD(60Hz) / 8.3 BTD(50Hz), 11.0 WMD(60Hz) / 8.3 WMD(50Hz), 12.5 BTD(60Hz) / 9.4 BTD(50Hz), 12.5 BTDA(60Hz) / 9.4 BTDA(50Hz), 12.5 BTDB(60Hz) / 9.4 BTDB(50Hz), 12.5 WMD(60Hz) / 9.4 WMD(50Hz), 15.0 BTD(60Hz) / 12.0 BTD(50Hz), 15.0 BTDA(60Hz) / 12.0 BTDA(50Hz), 15.0 BTDB(60Hz) / 12.0 BTDB(50Hz), 15.0 BTDC(60Hz) / 12.0 BTDC(50Hz), 15.0 WTA(60Hz) / 12.0 WTA(50Hz), 20.0 BED(60Hz) / 16.0 BED(50Hz), 20.0 BEDA(60Hz) / 16.0 BEDA(50Hz), 20.0 WTA(60Hz) / 16.0 WTA(50Hz), 25.0 BED(60Hz) / 20.0 BED(50Hz), 25.0 WTA(60Hz) / 20.0 WTA(50Hz), 32.0 BED(60Hz) / 25.0 BED(50Hz), 32.0 BEDB(60Hz) / 25.0 BEDB(50Hz), 32.0 WTF(60Hz) / 25.0 WTF(50Hz)



**23-5840
TEMPERATURE SENDER**

Replaces: Westerbeke 35109
Fits several models. See application chart on pages 120-131



**23-5880
OIL PRESSURE SENDER**

Replaces: Westerbeke 24132
Fits several models. See application chart on pages 120-131



**23-2000
IMPELLER**

Replaces: **Westerbeke** 33112 (Impeller Only)
Fits: 6.5 TWG(60Hz)/4.9 TWG(50Hz), 8.0 TWG(60Hz)/6.4 TWG(50Hz), 8.5 BTG(60Hz)/6.5 BTG(50Hz), 11.0 TWG(60Hz)/8.5 TWG(50Hz), 12.5 BTG(60Hz)/10.0 BTG(50Hz), 15.0 BTG(60Hz)/12.0 BTG(50Hz), 15.0 BTGA(60Hz)/12.0 BTGA(50Hz), 20.0 WTA(60Hz)/16.0 WTA(50Hz)



**23-2001
IMPELLER**

Replaces: **Westerbeke** 32620 (Impeller Only)
Fits: 4.0 BCG(60Hz)/3.0 BCG(50Hz), 4.5 BCG(60Hz)/3.75 BCG(50Hz), 4.5 BCGB(60Hz)/3.75 BCGB(50Hz), 4.5 BCGTC(60Hz)/3.75 BCGTC(50Hz), 6.5 BCG(60Hz)/4.8 BCG(50Hz), 7.0 BCG(60Hz)/5.0 BCG(50Hz), 7.0 BCGA(60Hz)/5.0 BCGA(50Hz), 7.0 BCGB(60Hz)/6.0 BCGB(50Hz), 7.2 BCGTC(60Hz)/6.0 BCGTC(50Hz), 9.0 BTG(60Hz)/ 7.0 BTG(50Hz), 9.6 BCGTC(60Hz)/8.0 BCGTC(50Hz), 3.0 WMD(60Hz)/ 2.4 WMD(50Hz), 3.8/4.2 BCDT(60Hz) / 3.5 BCDT(50Hz), 5.0 BCG(60Hz)/ 4.2 BCG(50Hz), 5.0 BCGA(60Hz)/5.2 BCGA(50Hz), 7.0 BCGB(60Hz)/5.9 BCGB(50Hz), 8.0 BEG(60Hz)/6.4 BEG(50Hz), 10.0 BEG(60Hz)/8.0 BEG(50Hz), 12.5 BEG(60Hz)/10.0 BEG(50Hz), 15.0 BEG(60Hz)/12.0 BEG(50Hz)



**23-2002
IMPELLER**

Replaces: **Kohler** 229826
Fits: 8E (SN 296899 and Up), 10E (SN 296899 and Up), 12.5E (SN 296899 and Up), 12.5CF (SN 296899 and Up), 15C, 16CF, 20C



**23-2003
IMPELLER**

Replaces: **Kohler** 250872, **Jabsco** 22799-0001
Fits: 8E (SN 296898 and Below), 10E (SN 296898 and Below), 12.5E (SN 296898 and Below), 12.5CF (SN 296898 and Below)



**23-2004
IMPELLER KIT**

Replaces: **Kohler** 359978 (Impeller only)
Fits: Kohler Pump GM28487; Fits Models 4EF, 5E, 6EF, 7.3E, 4 EFCD, 5 ECD, 6 EFCD, 7.3 ECD,



**23-2005
IMPELLER KIT**

Replaces: **Northern Lights** 25-12009 (Impeller only)



**23-3300
IMPELLER KIT**

Replaces: **Onan** 132-0349
Fits: MDKAV, MDKBG, MDKAW (Spacesaver), MDKAZ, MDKBD, MDKBE, MDKBF, MDKBD (w/ Isolated Ground), MDKBE (w/ Isolated Ground), MDKBF (w/ Isolated Ground)



**23-3301
IMPELLER KIT**

Replaces: **Westerbeke** 11907
Fits: 20.0 BEG(60Hz)/16.0 BEG(50Hz), 25.0 BEG(60Hz)/20.0 BEG(50Hz), 20.0 SBEGA(60Hz)/16.0 SBEGA(50Hz), 22.5 SBEGA(60Hz)/18.7 SBEGA(50Hz), 22.5 SBEGA(60Hz)/18.7 SBEGA(50Hz), 20.0 BED(60Hz)/16.0 BED(50Hz), 20.0 BEDA(60Hz)/16.0 BEDA(50Hz), 25.0 BED(60Hz)/20.0 BED(50Hz), 25.0 WTA(60Hz)/20.0 WTA(50Hz), 32.0 BED(60Hz)/25.0 BED(50Hz), 32.0 BEDA(60Hz)/25.0 BEDA(50Hz), 32.0 BEDB(60Hz)/25.0 BEDB(50Hz), 32.0 WTF(60Hz)/25.0 WTF(50Hz)



**23-3302
IMPELLER KIT**

Replaces: **Westerbeke** 33112
Fits: 6.5 TWG(60Hz)/4.9 TWG(50Hz), 8.0 TWG(60Hz)/6.4 TWG(50Hz), 8.5 BTG(60Hz)/6.5 BTG(50Hz), 11.0 TWG(60Hz)/8.5 TWG(50Hz), 12.5 BTG(60Hz)/10.0 BTG(50Hz), 15.0 BTG(60Hz)/12.0 BTG(50Hz), 15.0 BTGA(60Hz)/12.0 BTGA(50Hz), 20.0 WTA(60Hz)/16.0 WTA(50Hz)
Includes **23-2000** Impeller



**23-3303
IMPELLER KIT**

Replaces: **Kohler** 229826
Fits: Kohler Pump GM46962; Fits: Models 8E (SN 296899 and Up), 10E (SN 296899 and Up), 12.5E (SN 296899 and Up), 12.5CF (SN 296899 and Up), 15C, 16CF, 20C



**23-3304
IMPELLER KIT**

Replaces: **Kohler** 229955
Fits: 8E (SN 296898 and Below), 10E (SN 296898 and Below), 12.5E (SN 296898 and Below), 12.5CF (SN 296898 and Below)



**23-3305
IMPELLER KIT**

Replaces: **Westerbeke** 32620
Fits: 4.0 BCG(60Hz)/3.0 BCG(50Hz), 4.5CG(60Hz)/3.75 BCG(50Hz), 4.5 BCGB(60Hz)/3.75 BCGB(50Hz), 4.5 BCGTC(60Hz)/3.75 BCGTC(50Hz), 6.5 BCG(60Hz)/4.8 BCG(50Hz), 7.0 BCG(60Hz)/5.0 BCG(50Hz), 7.0 BCGA(60Hz)/5.0 BCGA(50Hz), 7.0 BCGB(60Hz)/6.0 BCGB(50Hz), 7.2 BCGTC(60Hz)/6.0 BCGTC(50Hz), 9.0 BTG(60Hz)/ 7.0 BTG(50Hz), 9.6 BCGTC(60Hz)/8.0 BCGTC(50Hz), 3.0 WMD(60Hz)/ 2.4 WMD(50Hz), 3.8/4.2 BCDT(60Hz) / 3.5 BCDT(50Hz)



23-3306
IMPELLER KIT
Replaces: **Westerbeke** 46622
Fits: 5.0 BCG(60Hz)/4.2 BCG(50Hz), 5.0 BCGA(60Hz)/5.2 BCGA(50Hz), 7.0 BCGC(60Hz)/5.9 BCGC(50Hz), 8.0 BEG(60Hz)/6.4 BEG(50Hz), 10.0 BEG(60Hz)/8.0 BEG(50Hz), 12.5 BEG(60Hz)/10.0 BEG(50Hz), 15.0 BEG(60Hz)/12.0 BEG(50Hz)



23-3307
IMPELLER KIT
Replaces: **Westerbeke** 34440
Fits: 4.0 BCD(60Hz), 4.4 BCD(60Hz), 4.4 WMD(60Hz)/3.3 WMD(50Hz), 5.0 BCD(60Hz)/4.0 BCD(50Hz), 5.0 BCDA(60Hz)/4.0 BCDA(50Hz), 5.0 BCDB(60Hz)/4.0 BCDB(50Hz), 6.0 BCD(60Hz)/4.5 BCD(50Hz), 7.6 BTD(60Hz)/5.7 BTD(50Hz), 7.7 WMD(60Hz)/5.8 WMD(50Hz), 8.0 BTD(60Hz)/6.0 BTD(50Hz), 8.0 BTDA(60Hz)/6.0 BTDA(50Hz)(Before March 2004), 8.0 WMD(60Hz)/6.0 WMD(50Hz), 10.0 BTD(60Hz)/7.5 BTD(50Hz), 10.0 BTDA(60Hz)/7.5 BTDA(50Hz), 11.0 BTD(60Hz)/8.3 BTD(50Hz), 11.0 WMD(60Hz)/8.3 WMD(50Hz), 12.5 BTD(60Hz)/9.4 BTD(50Hz), 12.5 BTDA(60Hz)/9.4 BTDA(50Hz), 12.5 BTDB(60Hz)/9.4 BTDB(50Hz), 12.5 WMD(60Hz)/9.4 WMD(50Hz), 15.0 BTDC(60Hz)/12.0 BTDC(50Hz)



23-3308
IMPELLER KIT
Replaces: **Kohler** 352122
Fits: 33EFOZ, 33 CFOZ, 40 CFOZ, 40EOZ, 40EFOZ, 50 COZ, 50 CFOZ, 50EOZ, 55EFOZ, 65 COZ, 65EOZ, 70EFOZ, 80EOZ, 80EFOZ, 99EOZ



23-3309
IMPELLER KIT
Replaces: **Onan** 132-0436
Fits: MDDCA, MDDCB, MDDCC, MDDCF, MDDCG, MDDCD, MDDCE, MDDCH, MDDCJ



23-3310
IMPELLER KIT
Replaces: **Onan** 541-1519
Fits: MDKKB, MDKBL, MDKBM, MDKBN, MDKAL/A/B



23-3311
IMPELLER KIT
Replaces: **Fischer Panda** J009-46840
Mase 80161
Fits: AGTPM 4, PMS 4, IS 2.5, IS 4.0, IS 4.7, IS 7.1



23-3312
IMPELLER KIT
Replaces: **Fischer Panda** J009-1027B-1
Mase 92911
Fits: IS 13.2, IS 10.2, IS 14.0, IS 19.0, IS 23.1T, PMS 15, PMS 16 DP, PMS 20, PMS 22, PMS 25, PMS 30, PMS 40, PMS 50



23-3313
IMPELLER KIT
Replaces: **Westerbeke** 33104
Fits: 15.0 BTD(60Hz) / 12.0 BTD(50Hz), 15.0 BTDA(60Hz) / 12.0 BTDA(50Hz), 15.0 BTDB(60Hz) / 12.0 BTDB(50Hz), 15.0 WTA(60Hz) / 12.0 WTA(50Hz)



23-3314
IMPELLER KIT
Replaces: **Kohler** 359978
Fits: Kohler Pump GM28487; Fits Models 4EF, 5E, 6EF, 7.3E, 4 EFCD, 5 ECD, 6 EFCD, 7.3 ECD



23-3315
IMPELLER KIT
Replaces: **Northern Lights** 25-12009
Fits: M673LD3, M673L3, M673LD2, M673L2



23-0400
QUAD RING
Replaces: **Northern Lights** 25-12031



23-4005
SEA WATER PUMP BELT
Replaces: **Westerbeke** 13810
Fits: 32.0 BED(60Hz) / 25.0 BED(50Hz), 32.0 BEDA(60Hz) / 25.0 BEDA(50Hz), 32.0 BEDB(60Hz) / 25.0 BEDB(50Hz)



23-4006
SEA WATER PUMP BELT

Replaces: Westerbeke 31152
Fits: 20.0 BED(60Hz) / 16.0 BED(50Hz), 20.0 BEDA(60Hz) / 16.0 BEDA(50Hz), 20.0 WTA(60Hz) / 16.0 WTA(50Hz), 25.0 BED(60Hz) / 20.0 BED(50Hz)



23-4007
SEA WATER PUMP BELT

Replaces: Westerbeke 30376
Fits: 4.0 BCD(60Hz), 4.4 BCD(60Hz), 4.4 WMD(60Hz) / 3.3 WMD(50Hz), 5.0 BCD/BCDA/BCDB(60Hz) / 4.0 BCD/BCDA/BCDB(50Hz)



23-3600
THERMOSTAT

Replaces: Westerbeke 24688
Temperature Rating: 180°
Fits: 3.0 WMD(60Hz)/2.4 WMD(50Hz), 4.4 BCD(60Hz), 4.4 WMD(60Hz) / 3.3 WMD(50Hz), 7.7 WMD(60Hz) / 5.8 WMD(50Hz), 8.0 BTD(60Hz) / 6.0 BTD(50Hz), 8.0 BTDA(60Hz) / 6.0 BTDA(50Hz), 8.0 WMD(60Hz) / 6.0 WMD(50Hz), 10.0 BTD(60Hz) / 7.5 BTD(50Hz), 10.0 BTDA(60Hz) / 7.5 BTDA(50Hz), 11.0 BTD(60Hz) / 8.3 BTD(50Hz), 11.0 WMD(60Hz) / 8.3 WMD(50Hz), 12.5 BTD(60Hz) / 9.4 BTD(50Hz), 12.5 BTDA(60Hz) / 9.4 BTDA(50Hz), 12.5 BTDB(60Hz) / 9.4 BTDB(50Hz), 12.5 WMD(60Hz) / 9.4 WMD(50Hz), 12.6 BTD(60Hz) / 10.4 BTD(50Hz), 15.0 BTD(60Hz) / 12.0 BTD(50Hz), 15.0 BTDC(60Hz) / 12.0 BTDC(50Hz), 20.0 SBEG(60Hz) / 16.0 SBEG(50Hz), 20.0 SBEGA(60Hz) / 16.0 SBEGA(50Hz), 22.5 SBEG(60Hz) / 18.7 SBEG(50Hz), 22.5 SBEGA(60Hz) / 18.7 SBEGA(50Hz)



23-3601
THERMOSTAT

Replaces: Westerbeke 35736
Temperature Rating: 140°
Fits: 6.5 BCG(60Hz)/4.8 BCG(50Hz), 6.5 TWG(60Hz)/4.9 TWG(50Hz), 8.0 TWG(60Hz)/6.4 TWG(50Hz), 8.5 BTG(60Hz)/6.5 BTG(50Hz), 9.0 BTG(60Hz)/7.0 BTG(50Hz), 11.0 TWG(60Hz)/8.5 TWG(50Hz), 12.5 BTG(60Hz)/10.0 BTG(50Hz), 15.0 BTG/A(60Hz)/12.0 BTG/A(50Hz), 20.0 BEG(60Hz)/16.0 BEG(50Hz), 25.0 BEG(60Hz)/20.0 BEG(50Hz)



23-3602
THERMOSTAT

Replaces: Westerbeke 37387
Temperature Rating: 140°
Fits: 4.5 BCG(60Hz)/3.75 BCG(50Hz), 7.0 BCG(60Hz) / 5.0 BCG(50Hz), 7.0 BCGA(60Hz)/5.0 BCGA(50Hz)



23-3603
THERMOSTAT

Replaces: Westerbeke 39378
Temperature Rating: 160°
Fits: 4.5 BCGB(60Hz)/3.75 BCGB(50Hz), 4.5 BCGTC(60Hz)/3.75 BCGTC(50Hz), 5.0 BCG(60Hz)/4.2 BCG(50Hz), 5.0 BCGA(60Hz)/ 5.2 BCGA(50Hz), 7.0 BCGB(60Hz)/6.0 BCGB(50Hz), 7.0 BCGC(60Hz)/ 5.9 BCGC(50Hz), 7.2 BCGTC(60Hz)/6.0 BCGTC(50Hz), 5.0 SBCG(60Hz)/ 4.0 SBEG(50Hz), 6.5 SBCG(60Hz) / 5.4 SBCG(50Hz)



23-3604
THERMOSTAT

Replaces: Westerbeke 46097
Temperature Rating: 140°
Fits: 8.0 BEG(60Hz)/6.4 BEG(50Hz), 10.0 BEG(60Hz)/8.0 BEG(50Hz), 12.5 BEG(60Hz)/10.0 BEG(50Hz), 15.0 BEG(60Hz)/12.0 BEG(50Hz)



23-3605
THERMOSTAT

Replaces: Westerbeke 24690
Temperature Rating: 180°
Fits: 8.0 SBEG(60Hz) / 6.4 SBEG(50Hz), 10.0 SBEG(60Hz) / 8.0 SBEG(50Hz), 12.5 SBEG(60Hz) / 10.0 SBEG(50Hz), 14.0 SBEG(60Hz) / 11.6 SBEG(50Hz), 15.0 BTDA(60Hz) / 12.0 BTDA(50Hz), 15.0 BTDB(60Hz) / 12.0 BTDB(50Hz), 20.0 BED(60Hz) / 16.0 BED(50Hz), 20.0 BEDA(60Hz) / 16.0 BEDA(50Hz), 20.0 WTA(60Hz) / 16.0 WTA(50Hz), 25.0 BED(60Hz) / 20.0 BED(50Hz)



23-3606
THERMOSTAT

Replaces: Onan 309-0130
Temperature Rating: 143°
Fits: MDJA, MDJB, MDJC, MDJE, MDJF, MJA, MJB, MJC



23-3607
THERMOSTAT

Replaces: Kohler 352018
Temperature Rating: 195°
Fits: 33EFOZ(Variation 1), 33 CFOZ(Variation 1), 40 CFOZ(Variation 1), 40EOZ(Variation 1), 40EFOZ(Variation 1), 50 COZ(Variation 1), 50 CFOZ(Variation 1), 50EOZ(Variation 1), 55EFOZ(Variation 1), 65 COZ(Variation 1), 65EOZ(Variation 1), 70EFOZ(Variation 1), 80EOZ(Variation 1), 80EFOZ(Variation 1), 99EOZ(Variation 1), 100EFOZ(Variation 1), 125EOZ(Variation 1), 125EFOZ(Variation 1), 150EOZ(Variation 1)



23-3608
THERMOSTAT

Replaces: Kohler 249930
Temperature Rating: 190°
Fits: 4EF, 5E, 6EF, 7.3E, 8E, 10E, 12.5E, 12.5CF, 15C, 16CF, 20C



23-3609
THERMOSTAT

Replaces: Kohler 252896
Temperature Rating: 170°
Fits: 11 CCFZ, 11.5 CCFZ, 11EFOZ, 11.5EFOZ, 13EOZ, 13EFOZ, 13.5 CCOZ, 14 CCOZ, 14 EOZ, 15.5EOZ, 16EFOZ, 17.5EFOZ, 18.5 CCOZ, 19EFOZ, 20 CCFZ, 20EOZ, 20EFOZ, 23EOZ, 24 CCOZ, 24EOZ



23-3610
THERMOSTAT
Replaces: Kohler 267717
Temperature Rating: 180°
Fits: 3.5 CFZ, 3.5 EFZ, 4 CZ, 4 ESZ, 5 CFZ, 5 EFZ, 6.5 CZ, 6.5 ESZ



23-0800
THERMOSTAT GASKET
Replaces: Westerbeke 42260
Fits: 4.5 BCGB(60Hz)/3.75 BCGB(50Hz), 4.5 BCGTC(60Hz)/3.75 BCGTC(50Hz), 7.0 BCGB(60Hz)/6.0 BCGB(50Hz), 7.2 BCGTC(60Hz)/ 6.0 BCGTC(50Hz), 9.6 BCGTC(60Hz)/8.0 BCGTC(50Hz)



23-0801
THERMOSTAT GASKET
Replaces: Westerbeke 46124
Fits: 5.0 BCG(60Hz)/4.2 BCG(50Hz), 5.0 BCGA(60Hz)/5.2 BCGA(50Hz), 7.0 BCGC(60Hz)/5.9 BCGC(50Hz), 5.0 SBCG(60Hz) / 4.2 SBEG(50Hz), 6.5 SBCG(60Hz) / 5.4 SBCG(50Hz)

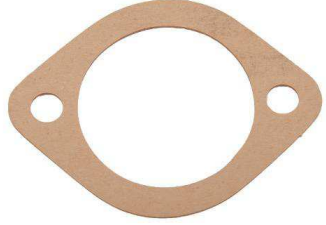

23-0802
THERMOSTAT GASKET
Replaces: Westerbeke 34196
Fits: 4.0 BCG(60Hz)/3.0 BCG(50Hz), 6.5 BCG(60Hz)/4.8 BCG(50Hz), 8.0 TWG(60Hz)/6.4 TWG(50Hz), 9.0 BTG(60Hz)/7.0 BTG(50Hz), 11.0 TWG(60Hz)/8.5 TWG(50Hz), 6.0 BCD(60Hz) / 4.5 BCD(50Hz), 8.0 BTD(60Hz) / 6.0 BTD(50Hz), 10.0 BTD(60Hz) / 7.5 BTD(50Hz), 11.0 BTD(60Hz) / 8.3 BTD(50Hz), 12.5 BTD(60Hz) / 9.4 BTD(50Hz), 12.5 BTDA(60Hz) / 9.4 BTDA(50Hz), 12.6 BTD(60Hz) / 10.4 BTD(50Hz)



23-0803
THERMOSTAT GASKET
Replaces: Westerbeke 33417
Fits: 6.5 TWG(60Hz)/4.9 TWG(50Hz), 8.0 BEG(60Hz)/6.4 BEG(50Hz), 8.5 BTG(60Hz)/6.5 BTG(50Hz), 10.0 BEG(60Hz)/8.0 BEG(50Hz), 12.5 BEG(60Hz)/10.0 BEG(50Hz), 12.5 BTG(60Hz)/10.0 BTG(50Hz), 15.0 BEG(60Hz)/12.0 BEG(50Hz), 15.0 BTG/A(60Hz)/12.0 BTG/A(50Hz), 8.0 SBEG(60Hz) / 6.4 SBEG(50Hz), 10.0 SBEG(60Hz) / 8.0 SBEG(50Hz), 12.5 SBEG(60Hz) / 10.0 SBEG(50Hz), 14.0 SBEG(60Hz) / 11.6 SBEG(50Hz)



23-0804
THERMOSTAT GASKET
Replaces: Westerbeke 33373
Fits: 15.0 BTDA(60Hz) / 12.0 BTDA(50Hz), 15.0 BTDB(60Hz) / 12.0 BTDB(50Hz), 15.0 WTA(60Hz) / 12.0 WTA(50Hz), 20.0 BED(60Hz) / 16.0 BED(50Hz), 20.0 BEDA(60Hz) / 16.0 BEDA(50Hz), 20.0 WTA(60Hz) / 16.0 WTA(50Hz), 25.0 BED(60Hz) / 20.0 BED(50Hz), 25.0 WTA(60Hz) / 20.0 WTA(50Hz)



23-0805
THERMOSTAT GASKET
Replaces: Westerbeke 40434
Fits: 20.0 BEG(60Hz)/16.0 BEG(50Hz), 25.0 BEG(60Hz)/20.0 BEG(50Hz), 20.0 SBEG(60Hz) / 16.0 SBEG(50Hz), 20.0 SBEGA(60Hz) / 16.0 SBEGA(50Hz), 22.5 SBEG(60Hz) / 18.7 SBEG(50Hz), 22.5 SBEGA(60Hz) / 18.7 SBEGA(50Hz)



23-0806
THERMOSTAT GASKET
Replaces: Westerbeke 24323
Fits: 4.4 BCD(60Hz), 4.4 WMD(60Hz) / 3.3 WMD(50Hz), 7.7 WMD(60Hz) / 5.8 WMD(50Hz), 8.0 WMD(60Hz) / 6.0 WMD(50Hz), 11.0 WMD(60Hz) / 8.3 WMD(50Hz), 12.5 WMD(60Hz) / 9.4 WMD(50Hz)



23-0807
THERMOSTAT GASKET
Replaces: Westerbeke 33966
Fits: 15.0 BTD(60Hz) / 12.0 BTD(50Hz)



23-0808
THERMOSTAT GASKET
Replaces: Westerbeke 37922
Fits: 4.5 BCG(60Hz)/3.75 BCG(50Hz), 7.0 BCG(60Hz)/5.0 BCG(50Hz), 7.0 BCGA(60Hz)/5.0 BCGA(50Hz)

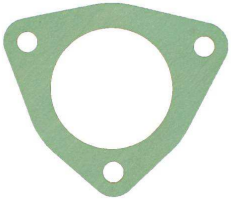

23-0809
THERMOSTAT GASKET
Replaces: Kohler 267718
Fits: 3.5CFZ, 4CZ, 5CFZ, 6.5CZ



23-0810
THERMOSTAT GASKET
Replaces: Kohler 229432
Fits: 11CCFOZ(variation 1,6), 11.5CCFOZ(variation 1,6), 11EFOZ(variation 1,6), 11.5EFOZ(variation 1,6), 13EOZ(variation 1,6), 13EFOZ(variation 1,6), 13.5CCOZ(variation 1,6), 14CCOZ(variation 1,6), 14EOZ(variation 1,6), 15CCFOZ, 15.5EOZ(variation 1,6), 16EFOZ, 17.5EFOZ, 18.5CCOZ, 19EFOZ, 20CCFOZ, 20EOZ, 20EFOZ, 23EOZ, 24CCOZ, 24EOZ



23-0811
THERMOSTAT GASKET
Replaces: Kohler 249865
Fits: 11CCFOZ(variation 2,3,4,5), 11.5CCFOZ(variation 2,3,4,5), 11EFOZ(variation 2,3,4,5), 11.5EFOZ(variation 2,3,4,5), 13EOZ(variation 2,3,4,5), 13EFOZ(variation 2,3,4,5), 13.5CCOZ(variation 2,3,4,5), 14CCOZ(variation 2,3,4,5), 14EOZ(variation 2,3,4,5), 15.5EOZ(variation 2,3,4,5), 11EFOZD, 11.5EFOZD, 13EOZD, 13EFOZD, 14EOZD, 15.5EOZD, 17EFOZD, 17.5EFOZD, 19EFOZD, 20EOZD, 20EFOZD, 23EOZD, 24EOZD



23-0812
THERMOSTAT GASKET

Replaces: Kohler 229433
Fits: 11 CCFDZ, 11.5 CCFDZ, 11EFOZ, 11.5EFOZ, 13EOZ, 13EFOZ, 13.5 CCOZ, 14 CCOZ, 14 EOZ, 15 CCFDZ, 15.5EOZ, 16EFOZ, 17.5EFOZ, 18.5 CCOZ, 19EFOZ, 20 CCFDZ, 20EOZ, 20EFOZ, 23EOZ, 24 CCOZ, 24EOZ, 11EFOZD, 11.5EFOZD, 11.5EFOZD, 13EFOZD, 14 EOZD, 15.5 EOZD, 17 EFOZD, 17.5EFOZD, 19EFOZD, 20EOZD, 20EFOZD, 23EOZD, 24EOZD



23-0813
THERMOSTAT GASKET

Replaces: Kohler 229963
Fits: 8E, 10E, 12.5E, 12.5CF, 15C, 16CF, 20C, 10EG, 13EG, 13EGZ, 15EG, 15EGZ, 4CCFOZ, 4EFOZ, 5CCOZ, 5EOZ, 6.5EFOZ, 8CCFOZ, 8EOZ, 8EFOZ, 9CCOZ, 9EOZ, 9EFOZ, 10EOZ, 23EFOZ, 27EFOZ, 28EOZ, 32EOZ, 6.5EFOZD, 7EFOZD, 8EOZD, 8.5EFOZD, 9EOZD, 9EFOZD, 10EOZD

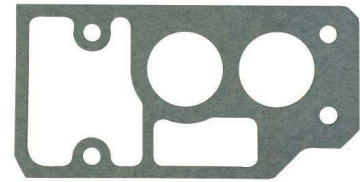

23-0814
THERMOSTAT GASKET

Replaces: Kohler 352031
Fits: 33EFOZ(variation 1,2,3), 33CFOZ(variation 1,2,3), 40CFOZ(variation 1,2,3), 40EOZ(variation 1,2,3), 40EFOZ(variation 1,2,3), 50COZ(variatin 1,2,3), 50CFOZ(variation 1,2,3), 50EOZ(variation 1,2,3), 55EFOZ(variation 1,2,3), 65COZ(variation 1,2,3), 65EFOZ(variation 1,2,3), 70EFOZ(variation 1,2,3), 80EOZ(variation 1,2,3), 80EFOZ(variation 1,2,3), 99EOZ(variation 1,2,3), 100EFOZ(variation 1,2,3), 125EOZ(variation 1,2,3), 125EFOZ(variation 1,2,3), 150EOZ(variation 1,2,3)



23-0830
THERMOSTAT GASKET

Replaces: Northern Lights 11-10015
Fits: Used with 35-12500 and 35-11000 thermostats



23-3650
THERMOSTAT KIT

Replaces: Westerbeke 24688, 24323
Temperature Rating: 180°
Fits: 4.4 BCD(60Hz), 4.4 WMD(60Hz) / 3.3 WMD(50Hz), 7.7 WMD(60Hz) / 5.8 WMD(50Hz), 8.0 WMD(60Hz) / 6.0 WMD(50Hz), 11.0 WMD(60Hz) / 8.3 WMD(50Hz), 12.5 WMD(60Hz) / 9.4 WMD(50Hz)



23-3651
THERMOSTAT KIT

Replaces: Westerbeke 35736, 34196
Temperature Rating: 140°
Fits: 4.0 BCG(60Hz)/3.0 BCG(50Hz), 6.5 BCG(60Hz)/4.8 BCG(50Hz), 8.0 TWG(60Hz)/6.4 TWG(50Hz), 9.0 BTG(60Hz)/7.0 BTG(50Hz), 11.0 TWG(60Hz)/8.5 TWG(50Hz)



23-3652
THERMOSTAT KIT

Replaces: Westerbeke 35736, 33417
Temperature Rating: 140°
Fits: 6.5 TWG(60Hz)/4.9 TWG(50Hz), 8.5 BTG(60Hz)/6.5 BTG(50Hz), 12.5 BTG(60Hz)/10.0 BTG(50Hz), 15.0 BTG/A(60Hz)/12.0 BTG/A(50Hz)



23-3653
THERMOSTAT KIT

Replaces: Westerbeke 24688, 34196
Temperature Rating: 180°
Fits: 8.0 BTD(60Hz) / 6.0 BTD(50Hz), 10.0 BTD(60Hz) / 7.5 BTD(50Hz), 11.0 BTD(60Hz) / 8.3 BTD(50Hz), 12.5 BTD(60Hz) / 9.4 BTD(50Hz), 12.5 BTDA(60Hz) / 9.4 BTDA(50Hz), 12.6 BTD(60Hz) / 10.4 BTD(50Hz)



23-3654
THERMOSTAT KIT

Replaces: Westerbeke 39378, 42260
Temperature Rating: 160°
Fits: 4.5 BCGB(60Hz)/3.75 BCGB(50Hz), 4.5 BCGTC(60Hz)/3.75 BCGTC(50Hz), 7.0 BCGB(60Hz)/6.0 BCGB(50Hz), 7.2 BCGTC(60Hz)/6.0 BCGTC(50Hz), 9.6 BCGTC(60Hz)/8.0 BCGTC(50Hz)



23-3655
THERMOSTAT KIT

Replaces: Westerbeke 39378, 46124
Temperature Rating: 160°
Fits: 5.0 BCG(60Hz)/4.2 BCG(50Hz), 5.0 BCGA(60Hz)/5.2 BCGA(50Hz), 7.0 BCGC(60Hz)/5.9 BCGC(50Hz), 5.0 SBEG(60Hz) / 4.0 SBEG(50Hz), 6.5 SBEG(60Hz) / 5.4 SBEG(50Hz)



23-3656
THERMOSTAT KIT

Replaces: Westerbeke 46097, 33417
Temperature Rating: 140°
Fits: 8.0 BEG(60Hz)/6.4 BEG(50Hz), 10.0 BEG(60Hz)/8.0 BEG(50Hz), 12.5 BEG(60Hz)/10.0 BEG(50Hz), 15.0 BEG(60Hz)/12.0 BEG(50Hz)



23-3657
THERMOSTAT KIT

Replaces: Westerbeke 24690, 33417
Temperature Rating: 180°
Fits: 8.0 SBEG(60Hz) / 6.4 SBEG(50Hz), 10.0 SBEG(60Hz) / 8.0 SBEG(50Hz), 12.5 SBEG(60Hz) / 10.0 SBEG(50Hz), 14.0 SBEG(60Hz) / 11.6 SBEG(50Hz)



23-3658
THERMOSTAT KIT
Replaces: **Westerbeke** 24688, 33966
Temperature Rating: 180°
Fits: 15.0 BTD(60Hz) / 12.0 BTD(50Hz)



23-3659
THERMOSTAT KIT
Replaces: **Westerbeke** 37387, 37922
Temperature Rating: 140°
Fits: 4.5 BCG(60Hz)/3.75 BCG(50Hz), 7.0 BCG(60Hz)/5.0 BCG(50Hz), 7.0 BCGA(60Hz)/5.0 BCGA(50Hz)



23-3660
THERMOSTAT KIT
Replaces: **Westerbeke** 24690, 33373
Temperature Rating: 180°
Fits: 15.0 BTDA(60Hz) / 12.0 BTDA(50Hz), 15.0 BTDB(60Hz) / 12.0 BTDB(50Hz), 15.0 WTA(60Hz) / 12.0 WTA(50Hz), 20.0 BED(60Hz) / 16.0 BED(50Hz), 20.0 BEDA(60Hz) / 16.0 BEDA(50Hz), 20.0 WTA(60Hz) / 16.0 WTA(50Hz), 25.0 BED(60Hz) / 20.0 BED(50Hz), 25.0 WTA(60Hz) / 20.0 WTA(50Hz)



23-3661
THERMOSTAT KIT
Replaces: **Westerbeke** 35736, 40434
Temperature Rating: 140°
Fits: 20.0 BEG(60Hz)/16.0 BEG(50Hz), 25.0 BEG(60Hz)/20.0 BEG(50Hz)



23-3662
THERMOSTAT KIT
Replaces: **Westerbeke** 24688, 40434
Temperature Rating: 180°
Fits: 20.0 SBEG(60Hz) / 16.0 SBEG(50Hz), 20.0 SBEGA(60Hz) / 16.0 SBEGA(50Hz), 22.5 SBEG(60Hz) / 18.7 SBEG(50Hz), 22.5 SBEGA(60Hz) / 18.7 SBEGA(50Hz)



23-3663
THERMOSTAT KIT
Replaces: **Kohler** 267717, 267718
Temperature Rating: 180°
Fits: 3.5 CFZ, 4 CZ, 5 CFZ, 6.5 CZ



23-3664
THERMOSTAT KIT
Replaces: **Kohler** 249930, 29963
Temperature Rating: 190°
Fits: 8E, 10E, 12.5E, 12.5CF, 15C, 16CF, 20C, 10 EG, 13 EG, 13 EGZ, 15 EG, 15 EGZ



23-3665
THERMOSTAT KIT
Replaces: **Kohler** 252896, 229432
Temperature Rating: 170°
Fits: 11 CCFZ(Variation 1, 6), 11.5 CCFZ(Variation 1, 6), 11.5EFOZ(Variation 1, 6), 11.5EFOZ(Variation 1, 6), 13.5 EOEZ(Variation 1, 6), 13.5EFOZ(Variation 1, 6), 13.5 CCOZ(Variation 1, 6), 14 CCOZ(Variation 1, 6), 14 EOEZ(Variation 1, 6), 15.5EOZ(Variation 1, 6), 16EFOZ, 17.5EFOZ, 18.5 CCOZ, 19EFOZ, 20 CCFZ, 20EOZ, 20EFOZ, 23EOZ, 24 CCOZ, 24EOZ



23-3666
THERMOSTAT KIT
Replaces: **Kohler** 352018, 352031
Temperature Rating: 195°
Fits: 33EFOZ(Variation 1), 33 CFOZ(Variation 1), 40 CFOZ(Variation 1), 40EOZ(Variation 1), 40EFOZ(Variation 1), 50 COZ(Variation 1), 50 CFOZ(Variation 1), 50EOZ(Variation 1), 55EFOZ(Variation 1), 65 COZ(Variation 1), 65EOZ(Variation 1), 70EFOZ(Variation 1), 80EOZ(Variation 1), 80EFOZ(Variation 1), 99EOZ(Variation 1), 100EFOZ(Variation 1), 125EOZ(Variation 1), 125EFOZ(Variation 1), 150EOZ(Variation 1)



23-2700
DISTRIBUTOR CAP
Replaces: **Westerbeke** 40859
Fits: 20.0 BEG(60Hz)/16.0 BEG(50Hz), 25.0 BEG(60Hz)/20.0 BEG(50Hz), 20.0 SBEG(60Hz) / 16.0 SBEG(50Hz), 20.0 SBEGA(60Hz) / 16.0 SBEGA(50Hz), 22.5 SBEG(60Hz) / 18.7 SBEG(50Hz), 22.5 SBEGA(60Hz) / 18.7 SBEGA(50Hz)



23-2701
DISTRIBUTOR CAP
Replaces: **Westerbeke** 34113
Fits: 6.5 TWG(60Hz)/4.9 TWG(50Hz), 8.0 TWG(60Hz)/6.4 TWG(50Hz), 11.0 TWG(60Hz)/8.5 TWG(50Hz), 8.5 BTG(60Hz)/6.5 BTG(50Hz), 12.5 BTG(60Hz)/10.0 BTG(50Hz), 15.0 BTG/A(60Hz)/12.0 BTG/A(50Hz)



23-2702
DISTRIBUTOR CAP
Replaces: **Westerbeke** 35608
Fits: 6.5 BCG(60Hz)/4.8 BCG(50Hz), 9.0 BTG(60Hz)/7.0 BTG(50Hz)



23-2703
DISTRIBUTOR CAP
Replaces: **Westerbeke** 46592
Fits: 8.0 BEG(60Hz)/6.4 BEG(50Hz), 10.0 BEG(60Hz)/8.0 BEG(50Hz), 12.5 BEG(60Hz)/10.0 BEG(50Hz), 15.0 BEG(60Hz)/12.0 BEG(50Hz), 8.0 SBEG(60Hz) / 6.4 SBEG(50Hz), 10.0 SBEG(60Hz) / 8.0 SBEG(50Hz), 12.5 SBEG(60Hz) / 10.0 SBEG(50Hz), 14.0 SBEG(60Hz) / 11.6 SBEG(50Hz)



**23-4500
PLUG WIRE SET**

Replaces: Westerbeke 43060
Fits: 4.5 BCG(60Hz)/3.75 BCG(50Hz), 4.5 BCGTC(60Hz)/3.75 BCGTC(50Hz), 4.5 BCGTE(60Hz)/3.75 BCGTE(50Hz), 5.0 BCG(60Hz)/4.2 BCG(50Hz), 5.0 BCGA(60Hz)/5.2 BCGA(50Hz), 7.0 BCGB(60Hz)/6.0 BCGB(50Hz), 7.0 BCGC(60Hz)/5.9 BCGC(50Hz), 7.0 BCGD(60Hz)/5.8 BCGD(50Hz), 7.2 BCGTC(60Hz)/6.0 BCGTC(50Hz), 9.6 BCGTC(60Hz)/8.0 BCGTC(50Hz), 9.6 BCGTE(60Hz)/8.0 BCGTE(50Hz)



**23-4501
PLUG WIRE SET**

Replaces: Westerbeke 46596
Fits: 8.0 BEG(60Hz)/6.4 BEG(50Hz), 10.0 BEG(60Hz)/8.0 BEG(50Hz), 12.5 BEG(60Hz)/10.0 BEG(50Hz), 15.0 BEG(60Hz)/12.0 BEG(50Hz), 10.0 SBEG(60Hz) / 6.4 SBEG(50Hz), 10.0 SBEG(60Hz) / 8.0 SBEG(50Hz), 12.5 SBEG(60Hz) / 10.0 SBEG(50Hz), 14.0 SBEG(60Hz) / 11.6 SBEG(50Hz)



**23-2800
ROTOR**

Replaces: Westerbeke 34093
Fits: 6.5 TWG(60Hz)/4.9 TWG(50Hz), 8.0 TWG(60Hz)/6.4 TWG(50Hz), 8.5 BTG(60Hz)/6.5 BTG(50Hz), 11.0 TWG(60Hz)/8.5 TWG(50Hz), 12.5 BTG(60Hz)/10.0 BTG(50Hz), 15.0 BTG/A(60Hz)/12.0 BTG/A(50Hz)



**23-2801
ROTOR**

Replaces: Westerbeke 35610
Fits: 4.0 BCG(60Hz)/3.0 BCG(50Hz)



**23-2802
ROTOR**

Replaces: Westerbeke 40860
Fits: 20.0 BEG(60Hz)/16.0 BEG(50Hz), 25.0 BEG(60Hz)/20.0 BEG(50Hz), 20.0 SBEG(60Hz) / 16.0 SBEG(50Hz), 20.0 SBEGA(60Hz) / 16.0 SBEGA(50Hz), 22.5 SBEG(60Hz) / 18.7 SBEG(50Hz), 22.5 SBEGA(60Hz) / 18.7 SBEGA(50Hz)



**23-2803
ROTOR**

Replaces: Westerbeke 43050
Fits: 4.5 BCG(60Hz)/3.75 BCG(50Hz), 4.5 BCGTC(60Hz)/3.75 BCGTC(50Hz), 5.0 BCG(60Hz)/4.2 BCG(50Hz), 5.0 BCGA(60Hz)/5.2 BCGA(50Hz), 7.0 BCGB(60Hz)/6.0 BCGB(50Hz), 7.0 BCGC(60Hz)/5.9 BCGC(50Hz), 7.2 BCGTC(60Hz)/6.0 BCGTC(50Hz), 8.0 BEG(60Hz)/6.4 BEG(50Hz), 9.6 BCGTC(60Hz)/8.0 BCGTC(50Hz), 10.0 BEG(60Hz)/8.0 BEG(50Hz), 12.5 BEG(60Hz)/10.0 BEG(50Hz), 15.0 BEG(60Hz)/12.0 BEG(50Hz), 5.0 SBEG(60Hz) / 4.0 SBEG(50Hz), 6.5 SBEG(60Hz) / 5.4 SBEG(50Hz), 8.0 SBEG(60Hz) / 6.4 SBEG(50Hz), 10.0 SBEG(60Hz) / 8.0 SBEG(50Hz), 12.5 SBEG(60Hz) / 10.0 SBEG(50Hz), 14.0 SBEG(60Hz) / 11.6 SBEG(50Hz)



**23-2804
ROTOR**

Replaces: Westerbeke 42201
Fits: 4.5 BCG(60Hz)/3.75 BCG(50Hz), 7.0 BCG(60Hz)/5.0 BCG(50Hz), 7.0 BCGA(60Hz)/5.0 BCGA(50Hz), 9.0 BTG(60Hz)/7.0 BTG(50Hz), 6.5 BCG(60Hz)/4.8 BCG(50Hz)



**23-7800
OIL FILTER**

Replaces: Westerbeke 36918
Fits: several models. See application chart on page 120-131



**23-7801
OIL FILTER**

Replaces: Westerbeke 35595
Notern Lights 24-0200
Fits: 4.0 BCG(60Hz)/3.0 BCG(50Hz), 6.5 BCG(60Hz)/4.8 BCG(50Hz), 9.0 BTG(60Hz)/7.0 BTG(50Hz), M753, M753G, M753K, M753W, M753W2, M773, LW2



**23-7802
OIL FILTER**

Replaces: Westerbeke 48078
Fits: 3.0 BPMG (60Hz)



**23-7803
OIL FILTER**

Replaces: Kohler 326817
Fits: 8E, 10E, 12.5E



**23-7804
OIL FILTER**

Replaces: Onan 185-7444
(Fits: MDKAU, MDKBH)
Fischer Panda 15853-99170
Fits: PMS 8 MINI, PMS 8 DP, PMS 4200, PMS 6500, PMS 12 DP, PMS 12 Mini



**23-7820
OIL FILTER**

Replaces: Kohler 279449
Fits: 12.5CF, 15C, 16CF, 20C



23-7821
OIL FILTER
Replaces: Kohler 359771
Fits: 4EF, 5E, 6EF, 7.3E



23-7822
OIL FILTER
Replaces: Kohler 229678
Fits: 4 CCFOZ, 4 EFOZ, 5 CCOZ, 5 EOZ, 6.5 EFOZ, 8 EOZ



23-7823
OIL FILTER
Replaces: Kohler 267714
Fits: 3.5 CFZ, 3.5 EFZ, 4 CZ, 4 ESZ, 5 CFZ, 5 EFZ, 6.5 CZ, 6.5 ESZ



23-7824
OIL FILTER
Replaces: Kohler GM47465
Fits: 7 EFOZD(Var 1), 8.5 EFOZD(Var 1), 9 EOZD(Var 1), 9 EFOZD (Var 1), 10 EOZD(Var 1), 11 EFOZD, 11.5 EFOZD, 13 EOZD, 13 EFOZD, 14 EOZD, 15.5 EOZD, 17 EFOZD, 17.5 EFOZD, 19 EFOZD, 20 EOZD, 20 EFOZD, 23 EOZD, 24 EOZD



23-7825
OIL FILTER
Replaces: Westerbeke 35828
Fits: 11.0 BTD(60Hz) / 8.3 BTD(50Hz), 12.5 BTD(60Hz) / 9.4 BTD(50Hz), 12.5 BTDA(60Hz) / 9.4 BTDA(50Hz), 12.5 WMD(60Hz) / 9.4 WMD(50Hz), 15.0 BTD(60Hz) / 12.0 BTD(50Hz), 15.0 BTDA(60Hz) / 12.0 BTDA(50Hz), 15.0 BTDB(60Hz) / 12.0 BTDB(50Hz)



23-7826
OIL FILTER
Replaces: Westerbeke 40154
Fits: 20.0 BED(60Hz) / 16.0 BED(50Hz), 20.0 BEDA(60Hz) / 16.0 BEDA(50Hz), 25.0 BED(60Hz) / 20.0 BED(50Hz), 25.0 WTA(60Hz) / 20.0 WTA(50Hz), 32.0 BED(60Hz) / 25.0 BED(50Hz), 32.0 BEDA(60Hz) / 25.0 BEDA(50Hz)



23-7840
OIL FILTER
Replaces: Onan 122-0810
Fits: MDKBD, MDKBE, MDKBF, MDKBD (w/ Isolated Ground), MDKBE (w/ Isolated Ground), MDKBF (w/ Isolated Ground), MDKAD/E/F



23-7841
OIL FILTER
Replaces: Onan 122-0185
Fits: MDJB, MDJC, MDJE, MDJF, MJA, MJB, MJC



23-7842
OIL FILTER
Replaces: Onan 185-5835
Fits: MDKAV, MDKBG, MDKAW (Spacesaver), MDKAZ, MDKAL/A/B, MDKKB, MDKBL, MDKBM, MDKBN

As with Marine Engines, Generators require routine maintenance and changing of engine oil is critical to maintaining and extending their useful life. With the addition of many oil filters for the Marine Generator market, Sierra offers several grades of oil for the gasoline and diesel Generator applications. These oils are specifically formulated for the Marine Industry to provide excellent lubrication and corrosion protection. All of these oils are backed by Sierra's **Industry Leading Warranty**.

Part#	Description	Qty	Case Qty
18-9420-2	10W30 4-Stroke	Qt.	12
18-9400-2	25W40 4-Stroke	Qt.	12
18-9553-2	15W40 Diesel Oil	Qt.	12
18-9410-2	SAE 30 Full Syn.	Qt.	12





56966P
HOURMETER
Round





56967P
HOURMETER
Rectangular





23-6400
ANODE

Replaces:

Westerbeke 11885, Kohler 260085
Fits several models. See application chart on page 120-131



23-6401
ANODE

Replaces: Onan 130-4434

Fits: MDKAV, MDKBG, MDKAW (Spacesaver), MDKAZ, MDKBD, MDKBE, MDKBF, MDKBD (w/ Isolated Ground), MDKBE (w/ Isolated Ground), MDKBF (w/ Isolated Ground), MDKBH, MDKKB, MDKBL, MDKBM, MDKBN, MDKBP, MDKBR, MDKBS, MDKBV, MDKBT, MDKBU



23-6402
ANODE

Replaces: Onan 130-6228

Fits: MDDCA, MDDCB, MDDCC, MDDCF, MDDCG, MDDCD, MDDCE, MDDCH, MDDCJ



23-5800
SOLENOID

Replaces: Westerbeke 24639

Fits: 3.0 WMD(60Hz)/2.4 WMD(50Hz), 4.0 BCD(60Hz), 4.4 BCD(60Hz), 4.4 WMD(60Hz) / 3.3 WMD(50Hz), 5.0 BCD/BCDA/BCDB(60Hz) / 4.0 BCD/BCDA/BCDB(50Hz), 6.0 BCD(60Hz) / 4.5 BCD(50Hz), 7.6 BTD(60Hz) / 5.7 BTD(50Hz), 7.7 WMD(60Hz) / 5.8 WMD(50Hz), 8.0 BTD(60Hz) / 6.0 BTD(50Hz), 8.0 BTDA(60Hz) / 6.0 BTDA(50Hz), 8.0 WMD(60Hz) / 6.0 WMD(50Hz), 10.0 BTD(60Hz) / 7.5 BTD(50Hz) / 8.3 WMD(50Hz), 12.5 BTD(60Hz) / 9.4 BTD(50Hz), 12.5 BTDA(60Hz) / 9.4 BTDA(50Hz) / 8.3 WMD(50Hz), 12.5 BTDB(60Hz) / 9.4 BTDB(50Hz), 12.5 WMD(60Hz) / 9.4 WMD(50Hz), 15.0 BTD(60Hz) / 12.0 BTD(50Hz), 15.0 BTDA(60Hz) / 12.0 BTDA(50Hz), 15.0 BTDB(60Hz) / 12.0 BTDB(50Hz), 15.0 BTDC(60Hz) / 12.0 BTDC(50Hz), 15.0 WTA(60Hz) / 12.0 WTA(50Hz), 20.0 BED(60Hz) / 16.0 BED(50Hz), 20.0 BEDA(60Hz) / 16.0 BEDA(50Hz), 20.0 WTA(60Hz) / 16.0 WTA(50Hz), 25.0 BED(60Hz) / 20.0 BED(50Hz), 25.0 WTA(60Hz) / 20.0 WTA(50Hz), 32.0 BED(60Hz) / 25.0 BED(50Hz), 32.0 BEDA(60Hz) / 25.0 BEDA(50Hz), 32.0 BEDB(60Hz) / 25.0 BEDB(50Hz), 32.0 WTF(60Hz) / 25.0 WTF(50Hz)



23-5900
ALTERNATOR (50 AMP)

Replaces: Westerbeke 30594

Fits: 4.4 BCD(60Hz), 4.4 WMD(60Hz)/3.3 WMD(50Hz), 6.0 BCD(60Hz)/ 4.5 BCD(50Hz), 7.7 WMD(60Hz)/5.8 WMD(50Hz), 8.0 BTD(60Hz)/ 6.0 BTD(50Hz), 8.0 WMD(60Hz)/6.0 WMD(50Hz), 10.0 BTD(60Hz)/ 7.5 BTD(50Hz), 11.0 BTD(60Hz)/8.3 BTD(50Hz), 12.5 BTD(60Hz)/9.4 BTD(50Hz), 12.5 BTDA(60Hz)/9.4 BTDA(50Hz), 12.5 WMD(60Hz)/ 9.4 WMD(50Hz), 15.0 BTD(60Hz)/12.0 BTD(50Hz)



23-4000
ALTERNATOR BELT

Replaces: Westerbeke 39181

Fits: 20.0 BED(60Hz) / 16.0 BED(50Hz), 20.0 BEDA(60Hz) / 16.0 BEDA(50Hz), 25.0 BED(60Hz) / 20.0 BED(50Hz)



23-4001
ALTERNATOR BELT

Replaces: Westerbeke 11672

Fits: 15.0 BTDA(60Hz) / 12.0 BTDA(50Hz), 15.0 BTDB(60Hz) / 12.0 BTDB(50Hz), 20.0 WTA(60Hz) / 16.0 WTA(50Hz)



23-4002
ALTERNATOR BELT

Replaces: Westerbeke 30592

Fits: 6.5 TWG(60Hz)/4.9 TWG(50Hz), 8.0 TWG(60Hz)/6.4 TWG(50Hz), 11.0 TWG(60Hz)/8.5 TWG(50Hz), 6.0 BCD(60Hz) / 4.5 BCD(50Hz), 7.7 WMD(60Hz) / 5.8 WMD(50Hz), 8.0 WMD(60Hz) / 6.0 WMD(50Hz), 11.0 BTD(60Hz) / 8.3 BTD(50Hz)



23-4003
ALTERNATOR BELT

Replaces: Westerbeke 45232

Fits: 7.6 BTD(60Hz) / 5.7 BTD(50Hz), 8.0 BTDA(60Hz) / 6.0 BTDA(50Hz), 10.0 BTDA(60Hz) / 7.5 BTDA(50Hz), 12.5 BTDB(60Hz) / 9.4 BTDB(50Hz), 15.0 BTDC(60Hz) / 12.0 BTDC(50Hz)



23-4004
ALTERNATOR BELT

Replaces: Westerbeke 30475

Fits: 12.5 BTG(60Hz)/10.0 BTG(50Hz), 15.0 BTG/A(60Hz)/12.0 BTG/A(50Hz), 8.0 BTD(60Hz) / 6.0 BTD(50Hz), 10.0 BTD(60Hz) / 7.5 BTD(50Hz), 12.5 BTD(60Hz) / 9.4 BTD(50Hz), 12.5 BTDA(60Hz) / 9.4 BTDA(50Hz), 12.5 WMD(60Hz) / 9.4 WMD(50Hz), 15.0 BTD(60Hz) / 12.0 BTD(50Hz)



23-5600
STARTER

Replaces: Westerbeke 30593

Fits: 4.4 WMD(60Hz)/3.3 WMD(50Hz), 7.7 WMD(60Hz)/5.8 WMD(50Hz), 8.0 BTDA(60Hz)/6.0 BTDA(50Hz), 8.0 WMD(60Hz)/6.0 WMD(50Hz), 10.0 BTDA(60Hz)/7.5 BTDA(50Hz), 11.0 BTD(60Hz)/8.3 BTD(50Hz), 11.0 WMD(60Hz)/8.3 WMD(50Hz), 12.5 BTD(60Hz)/9.4 BTD(50Hz), 12.5 BTDA(60Hz)/9.4 BTDA(50Hz), 12.5 BTDB(60Hz)/9.4 BTDB(50Hz), 12.5 WMD(60Hz)/9.4 WMD(50Hz), 12.6 BTD(60Hz)/10.4 BTD(50Hz), 15.0 BTD(60Hz)/12.0 BTD(50Hz), 15.0 BTDA(60Hz)/12.0 BTDA(50Hz), 15.0 BTDB(60Hz)/12.0 BTDB(50Hz), 15.0 BTDC(60Hz)/12.0 BTDC(50Hz)

Sierra
The Very Best Parts of Boating

GENERATOR PARTS

Sierra offers over 100 products focused entirely on servicing the generator market. Applications cover all applicable product categories with a focus on Kohler®, Onan® & Westerbeke® Generator Sets.

Like all Sierra products, quality is insured by our industry leading Limited Lifetime Warranty.



THE VERY BEST PARTS OF BOATING

Model	OEM	Starter	Alternator	Fuel Filter	Impeller	Impeller Kit	Thermostat
3.0 WMD(60Hz)/2.4 WMD(50Hz)	Westerbeke	—	—	23-7770	23-2001	23-3305	23-3600
3.8/4.2 BCDT(60Hz) / 3.5 BCDT(50Hz)	Westerbeke	—	—	—	23-2001	23-3305	—
4.0 BCD(60Hz)	Westerbeke	—	—	23-7770	—	23-3307	—
4.4 BCD(60Hz)	Westerbeke	—	23-5900	—	23-2001	23-3307	23-3600
4.4 WMD(60Hz) / 3.3 WMD(50Hz)	Westerbeke	23-5600	23-5900	23-7770	—	23-3307	23-3600
5.0 BCD/BCDA/BCDB(60Hz) / 4.0 BCD/BCDA/BCDB(50Hz)	Westerbeke	—	—	23-7770	—	23-3307	—
5.0 BC DR(60Hz) / 4.0 BC DR(50Hz)	Westerbeke	—	—	—	—	—	—
6.0 BCD(60Hz) / 4.5 BCD(50Hz)	Westerbeke	—	23-5900	23-7770	—	23-3307	23-3600
7.6 BTD(60Hz) / 5.7 BTD(50Hz)	Westerbeke	—	—	23-7770	—	23-3307	—
7.7 WMD(60Hz) / 5.8 WMD(50Hz)	Westerbeke	23-5600	23-5900	23-7770	—	23-3307	23-3600
8.0 BTD(60Hz) / 6.0 BTD(50Hz)	Westerbeke	—	23-5900	23-7770	—	23-3307	23-3600
8.0 BTDA(60Hz) / 6.0 BTDA(50Hz)	Westerbeke	23-5600	—	23-7770	23-3307 (Before March 2004)	23-3307	23-3600
8.0 BCDT(60Hz) / 7.0 BCDT(50Hz)	Westerbeke	—	—	23-7770	—	—	—
8.0 WMD(60Hz) / 6.0 WMD(50Hz)	Westerbeke	23-5600	23-5900	23-7770	—	23-3307	23-3600
10.0 BTD(60Hz) / 7.5 BTD(50Hz)	Westerbeke	—	23-5900	23-7770	—	23-3307	23-3600
10.0 BTDA(60Hz) / 7.5 BTDA(50Hz)	Westerbeke	23-5600	—	23-7770	—	23-3307	23-3600
11.0 BTD(60Hz) / 8.3 BTD(50Hz)	Westerbeke	23-5600	23-5900	23-7770	—	23-3307	23-3600
11.0 WMD(60Hz) / 8.3 WMD(50Hz)	Westerbeke	23-5600	—	23-7770	—	23-3307	23-3600
12.5 BTD(60Hz) / 9.4 BTD(50Hz)	Westerbeke	23-5600	23-5900	23-7770	—	23-3307	23-3600
12.5 BTDA(60Hz) / 9.4 BTDA(50Hz)	Westerbeke	23-5600	23-5900	23-7770	—	23-3307	23-3600
12.5 BTDB(60Hz) / 9.4 BTDB(50Hz)	Westerbeke	23-5600	—	23-7770	—	23-3307	23-3600
12.5 WMD(60Hz) / 9.4 WMD(50Hz)	Westerbeke	23-5600	23-5900	23-7770	—	23-3307	23-3600
12.6 BTD(60Hz) / 10.4 BTD(50Hz)	Westerbeke	23-5600	—	23-7770	—	—	23-3600
15.0 BTD(60Hz) / 12.0 BTD(50Hz)	Westerbeke	23-5600	23-5900	23-7764	—	23-3313	23-3600
15.0 BTDA(60Hz) / 12.0 BTDA(50Hz)	Westerbeke	23-5600	—	23-7764	—	23-3313	23-3605
15.0 BTDB(60Hz) / 12.0 BTDB(50Hz)	Westerbeke	23-5600	—	23-7764	—	23-3313	23-3605
15.0 BTDC(60Hz) / 12.0 BTDC(50Hz)	Westerbeke	23-5600	—	23-7770	—	23-3307	23-3600
15.0 WTA(60Hz) / 12.0 WTA(50Hz)	Westerbeke	—	—	23-7764	—	23-3313	23-3605
20.0 BED(60Hz) / 16.0 BED(50Hz)	Westerbeke	—	—	23-7764	—	23-3301	23-3605
20.0 BEDA(60Hz) / 16.0 BEDA(50Hz)	Westerbeke	—	—	23-7764	—	23-3301	23-3605
20.0 WTA(60Hz) / 16.0 WTA(50Hz)	Westerbeke	—	—	23-7764	23-2000	23-3302	23-3605
25.0 BED(60Hz) / 20.0 BED(50Hz)	Westerbeke	—	—	23-7764	—	23-3301	23-3605
25.0 WTA(60Hz) / 20.0 WTA(50Hz)	Westerbeke	—	—	23-7764	—	23-3301	23-3605
32.0 BED(60Hz) / 25.0 BED(50Hz)	Westerbeke	—	—	23-7764	—	23-3301	—
32.0 BEDA(60Hz) / 25.0 BEDA(50Hz)	Westerbeke	—	—	23-7764	—	23-3301	23-3605
32.0 BEDB(60Hz) / 25.0 BEDB(50Hz)	Westerbeke	—	—	—	—	23-3301	—
32.0 WTF(60Hz) / 25.0 WTF(50Hz)	Westerbeke	—	—	23-7764	—	23-3301	—
3.0 BPMG (60Hz)	Westerbeke	—	—	23-7770	—	—	—
4.0 BCG(60Hz)/3.0 BCG(50Hz)	Westerbeke	—	—	23-7720	23-2001	23-3305	23-3601
4.5 BCG(60Hz)/3.75 BCG(50Hz)	Westerbeke	—	—	—	23-2001	23-3305	23-3602

Thermostat Kit	Oil Filter	Air Filter	Thermostat Gasket	Anode	Carburetor Kit	Glow Plug	Temperature Sender	Oil Pressure Sender	Solenoid
—	23-7800	—	—	23-6400	—	—	23-5840	23-5880	23-5800
—	—	—	—	—	—	—	—	—	—
—	23-7800	—	—	—	—	—	23-5840	23-5880	23-5800
23-3650	23-7800	—	23-0806	23-6400	—	23-1000	23-5840	23-5880	23-5800
23-3650	23-7800	—	23-0806	23-6400	—	23-1000	23-5840	23-5880	23-5800
—	23-7800	—	—	23-6400	—	—	23-5840	23-5880	23-5800
—	23-7800	—	—	—	—	—	—	—	—
—	23-7800	—	23-0802	23-6400	—	23-1000	23-5840	23-5880	23-5800
—	23-7800	—	—	—	—	—	—	23-5880	23-5800
23-3650	23-7800	—	23-0806	—	—	23-1000	23-5840	23-5880	23-5800
23-3653	23-7800	—	23-0802	—	—	23-1000	23-5840	23-5880	23-5800
—	23-7800	23-1101	—	—	—	23-1000	23-5840	23-5880	23-5800
—	23-7800	—	—	23-6400	—	—	—	—	—
23-3650	23-7800	—	23-0806	—	—	23-1000	23-5840	23-5880	23-5800
23-3653	23-7800	—	23-0802	23-6400	—	23-1000	23-5840	23-5880	23-5800
—	23-7800	23-1101	—	—	—	23-1000	23-5840	23-5880	23-5800
23-3653	23-7825	—	23-0802	—	—	23-1000	23-5840	23-5880	23-5800
23-3650	23-7800	—	23-0806	23-6400	—	23-1000	23-5840	23-5880	23-5800
23-3653	23-7825	—	23-0802	—	—	23-1000	23-5840	23-5880	23-5800
23-3653	23-7825	—	23-0802	—	—	23-1000	23-5840	23-5880	23-5800
—	23-7800	23-1101	—	—	—	23-1000	23-5840	23-5880	23-5800
23-3650	23-7825	—	23-0806	—	—	23-1000	23-5840	23-5880	23-5800
23-3653	23-7800	23-1101	23-0802	23-6400	—	—	—	—	—
23-3658	23-7825	—	23-0807	—	—	23-1000	23-5840	—	23-5800
23-3660	23-7825	—	23-0804	—	—	23-1000	23-5840	—	23-5800
23-3660	23-7825	—	23-0804	—	—	23-1000	23-5840	—	23-5800
—	23-7800	23-1101	—	—	—	23-1000	23-5840	—	23-5800
23-3660	—	—	23-0804	—	—	23-1000	23-5840	—	23-5800
23-3660	23-7826	—	23-0804	—	—	23-1000	23-5840	—	23-5800
23-3660	23-7826	—	23-0804	—	—	23-1000	23-5840	—	23-5800
23-3660	—	—	23-0804	—	—	23-1000	23-5840	—	23-5800
23-3660	23-7826	—	23-0804	—	—	23-1000	23-5840	—	23-5800
23-3660	23-7826	—	23-0804	—	—	23-1000	23-5840	—	23-5800
—	23-7826	—	—	—	—	23-1000	23-5840	—	23-5800
—	23-7826	—	—	—	—	—	23-5840	—	23-5800
—	23-7826	—	—	—	—	23-1000	23-5840	—	23-5800
—	23-7826	—	—	—	—	23-1000	23-5840	—	23-5800
—	23-7802	—	—	—	—	—	—	—	—
23-3651	23-7801	—	23-0802	23-6400	23-7201	—	23-5840	—	—
23-3659	23-7800	—	23-0808	23-6400	23-7201	—	23-5840	—	—

Model	OEM	Starter	Alternator	Fuel Filter	Impeller	Impeller Kit	Thermostat
4.5 BCGB(60Hz)/3.75 BCG(50Hz)	Westerbeke	—	—	—	23-2001	23-3305	23-3603
4.5 BCGTC(60Hz)/3.75 BCGTC(50Hz)	Westerbeke	—	—	—	23-2001	23-3305	23-3603
4.5 BCGTE(60Hz) / 3.75 BCGTE(50Hz)	Westerbeke						
5.0 BCG(60Hz)/4.2 BCG(50Hz)	Westerbeke	—	—	23-7770	23-2001	23-3306	23-3603
5.0 BCGA(60Hz)/5.2 BCGA(50Hz)	Westerbeke	—	—	23-7770	23-2001	23-3306	23-3603
6.5 BCG(60Hz)/4.8 BCG(50Hz)	Westerbeke	—	—	23-7720	23-2001	23-3305	23-3601
6.5 TWG(60Hz)/4.9 TWG(50Hz)	Westerbeke	—	—	23-7720	23-2000	23-3302	23-3601
7.0 BCG(60Hz)/5.0 BCG(50Hz)	Westerbeke	—	—	—	23-2001	23-3305	23-3602
7.0 BCGA(60Hz)/5.0 BCGA(50Hz)	Westerbeke	—	—	—	23-2001	23-3305	23-3602
7.0 BCGB(60Hz)/6.0 BCGB(50Hz)	Westerbeke	—	—	—	23-2001	23-3305	23-3603
7.0 BCGC(60Hz)/5.9 BCGC(50Hz)	Westerbeke	—	—	23-7770	23-2001	23-3306	23-3603
7.0 BCGD(60Hz) / 5.8 BCGD(50Hz)	Westerbeke			23-7770	23-2001	23-3306	—
7.2 BCGTC(60Hz)/6.0 BCGTC(50Hz)	Westerbeke	—	—	23-7770	23-2001	23-3305	23-3603
8.0 BEG(60Hz)/6.4 BEG(50Hz)	Westerbeke	—	—	23-7770	23-2001	23-3306	23-3605
8.0 TWG(60Hz)/6.4 TWG(50Hz)	Westerbeke	—	—	23-7720	23-2000	23-3302	23-3601
8.5 BTG(60Hz)/6.5 BTG(50Hz)	Westerbeke	—	—	—	23-2000	23-3302	23-3601
8.5 BTGA(60Hz) / 6.8 BTGA(50Hz)	Westerbeke				23-2000	23-3302	23-3601
9.0 BTG(60Hz)/7.0 BTG(50Hz)	Westerbeke	—	—	23-7720	23-2001	23-3305	23-3601
9.6 BCGTC(60Hz)/8.0 BCGTC(50Hz)	Westerbeke	—	—	—	23-2001	23-3305	23-3603
10.0 BEG(60Hz)/8.0 BEG(50Hz)	Westerbeke	—	—	23-7770	23-2001	23-3306	23-3605
11.0 TWG(60Hz)/8.5 TWG(50Hz)	Westerbeke	—	—	23-7720	23-2000	23-3302	23-3601
12.5 BEG(60Hz)/10.0 BEG(50Hz)	Westerbeke	—	—	23-7770	23-2001	23-3306	23-3605
12.5 BTG(60Hz)/10.0 BTG(50Hz)	Westerbeke	—	—	—	23-2000	23-3302	23-3601
15.0 BEG(60Hz)/12.0 BEG(50Hz)	Westerbeke	—	—	23-7770	23-2001	23-3306	23-3605
15.0 BTG/A(60Hz)/12.0 BTG/A(50Hz)	Westerbeke	—	—	—	23-2000	23-3302	23-3601
20.0 BEG(60Hz)/16.0 BEG(50Hz)	Westerbeke	—	—	—	—	23-3301	23-3601
25.0 BEG(60Hz)/20.0 BEG(50Hz)	Westerbeke	—	—	—	—	23-3301	23-3601
5.0 SBCG(60Hz) / 4.0 SBCG(50Hz)	Westerbeke	—	—	23-7770	23-2001	23-3306	23-3603
6.5 SBCG(60Hz) / 5.4 SBCG(50Hz)	Westerbeke	—	—	23-7770	23-2001	23-3306	23-3603
8.0 SBEG(60Hz) / 6.4 SBEG(50Hz)	Westerbeke	—	—	23-7770	23-2001	23-3306	23-3605
10.0 SBEG(60Hz) / 8.0 SBEG(50Hz)	Westerbeke	—	—	23-7770	23-2001	23-3306	23-3605
12.5 SBEG(60Hz) / 10.0 SBEG(50Hz)	Westerbeke	—	—	23-7770	23-2001	23-3306	23-3605
14.0 SBEG(60Hz) / 11.6 SBEG(50Hz)	Westerbeke	—	—	23-7770	23-2001	23-3306	23-3605
18.0 SBEG	Westerbeke						
18.0 SBEGA	Westerbeke						
20.0 SBEG(60Hz) / 16.0 SBEG(50Hz)	Westerbeke	—	—	23-7770	—	23-3301	23-3600
20.0 SBEGA(60Hz) / 16.0 SBEGA(50Hz)	Westerbeke	—	—	23-7770	—	23-3301	23-3600
22.5 SBEG(60Hz) / 18.7 SBEG(50Hz)	Westerbeke	—	—	23-7770	—	23-3301	23-3600
22.5 SBEGA(60Hz) / 18.7 SBEGA(50Hz)	Westerbeke	—	—	23-7770	—	23-3301	23-3600
5.5 EDC(60Hz) / 5.0 EDC(50Hz)	Westerbeke	—	—	23-7770	—	—	—

Thermostat Kit	Oil Filter	Air Filter	Thermostat Gasket	Anode	Carburetor Kit	Glow Plug	Temperature Sender	Oil Pressure Sender	Solenoid
23-3654	23-7800	—	23-0800	23-6400	23-7201	—	—	—	—
23-3654	23-7800	—	23-0800	23-6400	23-7201	—	—	—	—
	23-7800								
23-3655	23-7800	—	23-0801	23-6400	23-7201	—	—	—	—
23-3655	23-7800	—	23-0801	23-6400	—	—	—	—	—
23-3651	23-7801	—	23-0802	23-6400	23-7201	—	23-5840	—	—
23-3652	23-7800	—	23-0803	23-6400	23-7200	—	23-5840	—	—
23-3659	23-7800	—	23-0808	23-6400	23-7201	—	23-5840	—	—
23-3659	23-7800	—	23-0808	23-6400	23-7201	—	23-5840	—	—
23-3654	23-7800	—	23-0800	23-6400	23-7201	—	—	—	—
23-3655	23-7800	—	23-0801	23-6400	—	—	—	—	—
—	23-7800	—	—	23-6400	—	—	—	—	—
23-3654	23-7800	—	23-0800	23-6400	23-7201	—	—	—	—
23-3656	23-7800	—	23-0803	23-6400	23-7201	—	23-5840	23-5880	—
23-3651	23-7800	—	23-0802	23-6400	23-7200	—	23-5840	—	—
23-3652	23-7800	—	23-0803	23-6400	23-7200	—	23-5840	23-5880	—
—	23-7800	—	—	23-6400	23-7200	—	—	—	—
23-3651	23-7801	—	23-0802	23-6400	—	—	23-5840	—	—
23-3654	23-7800	—	23-0800	23-6400	23-7201	—	—	—	—
23-3656	23-7800	—	23-0803	23-6400	23-7201	—	23-5840	23-5880	—
23-3651	23-7800	—	23-0802	23-6400	—	—	23-5840	—	—
23-3656	23-7800	—	23-0803	23-6400	23-7201	—	23-5840	23-5880	—
23-3652	23-7800	—	23-0803	23-6400	23-7200	—	23-5840	23-5880	—
23-3656	23-7800	—	23-0803	23-6400	23-7201	—	23-5840	23-5880	—
23-3652	23-7800	—	23-0803	23-6400	23-7200	—	23-5840	23-5880	—
23-3661	23-7800	—	23-0805	23-6400	23-7200	—	23-5840	23-5880	—
23-3661	23-7800	—	23-0805	23-6400	23-7200	—	23-5840	23-5880	—
23-3655	23-7800	—	23-0801	23-6400	—	—	—	—	—
23-3655	23-7800	—	23-0801	23-6400	—	—	—	—	—
23-3657	23-7800	—	23-0803	23-6400	—	—	—	—	—
23-3657	23-7800	—	23-0803	23-6400	—	—	—	—	—
23-3657	23-7800	—	23-0803	23-6400	—	—	—	—	—
23-3657	23-7800	—	23-0803	23-6400	—	—	—	—	—
	23-7800								
	23-7800								
23-3662	23-7800	—	23-0805	23-6400	—	—	—	—	—
23-3662	23-7800	—	23-0805	23-6400	—	—	—	—	—
23-3662	23-7800	—	23-0805	23-6400	—	—	—	—	—
23-3662	23-7800	—	23-0805	23-6400	—	—	—	—	—
—	23-7800	—	—	23-6400	—	—	—	—	—

Model	OEM	Starter	Alternator	Fuel Filter	Impeller	Impeller Kit	Thermostat
7.6 EDT(60Hz) / 5.7 EDT(50Hz)	Westerbeke	—	—	23-7770	—	—	—
8.0 EDT(60Hz) / 6.0 EDT(50Hz)	Westerbeke	—	—	23-7770	—	—	—
10.0 EDT(60Hz) / 7.5 EDT(50Hz)	Westerbeke	—	—	23-7770	—	—	—
11.5 EDT(60Hz) / 9.2 EDT(50Hz)	Westerbeke	—	—	23-7770	—	—	—
12.5 EDT(60Hz) / 9.4 EDT(50Hz)	Westerbeke	—	—	23-7770	—	—	—
12.6 EDT(60Hz) / 10.4 EDT(50Hz)	Westerbeke	—	—	23-7770	—	—	—
15.0 EDT(60Hz) / 12.0 EDT(50Hz)	Westerbeke	—	—	23-7770	—	—	—
4 CCFOZ	Kohler	—	—	23-7751	23-2002(SN 296899 & Up) 23-2003(SN 296898 & below)	23-3303(SN 296899 & Up) 23-3304(SN 296898 & below)	—
4EFOZ	Kohler	—	—	23-7751	23-2002(SN 296899 & Up) 23-2003(SN 296898 & below)	23-3303(SN 296899 & Up) 23-3304(SN 296898 & below)	—
5 CCOZ	Kohler	—	—	23-7751	23-2002(SN 296899 & Up) 23-2003(SN 296898 & below)	23-3303(SN 296899 & Up) 23-3304(SN 296898 & below)	—
5EOZ	Kohler	—	—	23-7751	23-2002(SN 296899 & Up) 23-2003(SN 296898 & below)	23-3303(SN 296899 & Up) 23-3304(SN 296898 & below)	—
6.5 EFOZ	Kohler	—	—	23-7751	23-2002(SN 296899 & Up) 23-2003(SN 296898 & below)	23-3303(SN 296899 & Up) 23-3304(SN 296898 & below)	—
8EOZ	Kohler	—	—	23-7751	23-2002(SN 296899 & Up) 23-2003(SN 296898 & below)	23-3303(SN 296899 & Up) 23-3304(SN 296898 & below)	—
8EFOZ	Kohler	—	—		23-2002(SN 296899 & Up) 23-2003(SN 296898 & below)	23-3303(SN 296899 & Up) 23-3304(SN 296898 & below)	—
8CCFOZ	Kohler	—	—		23-2002(SN 296899 & Up) 23-2003(SN 296898 & below)	23-3303(SN 296899 & Up) 23-3304(SN 296898 & below)	—
9CCOZ	Kohler	—	—		23-2002(SN 296899 & Up) 23-2003(SN 296898 & below)	23-3303(SN 296899 & Up) 23-3304(SN 296898 & below)	—
9EOZ	Kohler	—	—		23-2002(SN 296899 & Up) 23-2003(SN 296898 & below)	23-3303(SN 296899 & Up) 23-3304(SN 296898 & below)	—
9EFOZ	Kohler	—	—		23-2002(SN 296899 & Up) 23-2003(SN 296898 & below)	23-3303(SN 296899 & Up) 23-3304(SN 296898 & below)	—
10EOZ	Kohler	—	—		23-2002(SN 296899 & Up) 23-2003(SN 296898 & below)	23-3303(SN 296899 & Up) 23-3304(SN 296898 & below)	—
11 CCFOZ	Kohler	—	—	23-7740(Var 2)	23-2003	23-3304	23-3609
11.5 CCFOZ	Kohler	—	—	23-7740(Var 2)	23-2003	23-3304	23-3609
11EFOZ	Kohler	—	—	23-7740(Var 2)	23-2003	23-3304	23-3609
11.5EFOZ	Kohler	—	—	23-7740(Var 2)	23-2003	23-3304	23-3609
13EOZ	Kohler	—	—	23-7740(Var 2)	23-2003	23-3304	23-3609
13EFOZ	Kohler	—	—	23-7740(Var 2)	23-2003	23-3304	23-3609
13.5 CCOZ	Kohler	—	—	23-7740(Var 2)	23-2003	23-3304	23-3609
14 CCOZ	Kohler	—	—	23-7740(Var 2)	23-2003	23-3304	23-3609
14 EOZ	Kohler	—	—	23-7740(Var 2)	23-2003	23-3304	23-3609
15 CCFOZ	Kohler	—	—	23-7740(Var 3)	23-2003	23-3304	23-3609
15.5EOZ	Kohler	—	—	23-7740(Var 2)	23-2003	23-3304	23-3609
16EFOZ	Kohler	—	—	23-7740(Var 3)	23-2003	23-3304	23-3609
17.5EFOZ	Kohler	—	—	23-7740(Var 3)	23-2003	23-3304	23-3609
18.5 CCOZ	Kohler	—	—	23-7740(Var 3)	23-2003	23-3304	23-3609
19EFOZ	Kohler	—	—	23-7740(Var 3)	23-2003	23-3304	23-3609
20 CCFOZ	Kohler	—	—	23-7740(Var 3)	23-2003	23-3304	23-3609

Model	OEM	Starter	Alternator	Fuel Filter	Impeller	Impeller Kit	Thermostat
20EOZ	Kohler	—	—	23-7740(Var 3)	23-2003	23-3304	23-3609
20EFOZ	Kohler	—	—	23-7740(Var 3)	23-2003	23-3304	23-3609
23EOZ	Kohler	—	—	23-7740(Var 3)	23-2003	23-3304	23-3609
24 CCOZ	Kohler	—	—	23-7740(Var 3)	23-2003	23-3304	23-3609
24EOZ	Kohler	—	—	23-7740(Var 3)	23-2003	23-3304	23-3609
6.5EFOZD	Kohler	—	—	23-7751	23-2002	23-3303	
7 EFOZD	Kohler	—	—	23-7761(Var 1)	23-2002	23-3303	—
8EOZD	Kohler	—	—	23-7751	23-2002	23-3303	—
8.5 EFOZD	Kohler	—	—	23-7761(Var 1)	23-2002	23-3303	—
9 EOZD	Kohler	—	—	23-7761(Var 1)	23-2002	23-3303	—
9EFOZD	Kohler	—	—	23-7761(Var 1)	23-2002	23-3303	—
10EOZD	Kohler	—	—	23-7761(Var 1)	23-2002	23-3303	—
11EFOZD	Kohler	—	—	23-7761(Var 1)	23-2003	23-3304	—
11.5EFOZD	Kohler	—	—	23-7761(Var 1)	23-2003	23-3304	—
13EOZD	Kohler	—	—	23-7761(Var 1)	23-2003	23-3304	—
13EFOZD	Kohler	—	—	23-7761(Var 1)	23-2003	23-3304	—
14 EOZD	Kohler	—	—	23-7761(Var 1)	23-2003	23-3304	—
15.5 EOZD	Kohler	—	—	23-7761(Var 1)	23-2003	23-3304	—
17 EFOZD	Kohler	—	—	23-7740(Var 3), 23-7761(Var 1)	23-2003	23-3304	—
17.5EFOZD	Kohler	—	—	23-7740(Var 3), 23-7761(Var 1)	23-2003	23-3304	—
19EFOZD	Kohler	—	—	23-7740(Var 3), 23-7761(Var 1)	23-2003	23-3304	—
20EOZD	Kohler	—	—	23-7740(Var 3), 23-7761(Var 1)	23-2003	23-3304	—
20EFOZD	Kohler	—	—	23-7740(Var 3), 23-7761(Var 1)	23-2003	23-3304	—
23EFOZ		—	—	—	23-2002	23-3303	—
23EOZD	Kohler	—	—	23-7740(Var 3), 23-7761(Var 1)	23-2003	23-3304	—
23EFOZD	Kohler	—	—	23-7761	23-2002	23-3303	—
24EOZD	Kohler	—	—	23-7740(Var 3), 23-7761(Var 1)	23-2003	23-3304	—
27EFOZ		—	—	—	23-2002	23-3303	—
27EFOZD	Kohler	—	—	23-7761	23-2002	23-3303	—
28EOZ		—	—	—	23-2002	23-3303	—
28EOZD	Kohler	—	—	23-7761	23-2002	23-3303	—
32EOZ		—	—	—	23-2002	23-3303	—
32EOZD	Kohler	—	—	23-7761	23-2002	23-3303	—
33EFOZ	Kohler	—	—	—	—	23-3308	—
33 CFOZ	Kohler	—	—	—	—	23-3308	23-3607
40 CFOZ	Kohler	—	—	—	—	23-3308	23-3607
40EOZ	Kohler	—	—	—	—	23-3308	—
40EFOZ	Kohler	—	—	—	—	23-3308	—
50 COZ	Kohler	—	—	—	—	23-3308	23-3607
50 CFOZ	Kohler	—	—	—	—	23-3308	23-3607
50EOZ	Kohler	—	—	—	—	23-3308	—
55EFOZ	Kohler	—	—	—	—	23-3308	—
65 COZ	Kohler	—	—	—	—	23-3308	23-3607
65EOZ	Kohler	—	—	—	—	23-3308	—
70EFOZ	Kohler	—	—	—	—	23-3308	—
80EOZ	Kohler	—	—	—	—	23-3308	—
80EFOZ	Kohler	—	—	—	—	23-3308	—
99EOZ	Kohler	—	—	—	—	23-3308	—
100EFOZ	Kohler	—	—	—	—	—	—
125EOZ	Kohler	—	—	—	—	—	—
125EFOZ	Kohler	—	—	—	—	—	—

Model	OEM	Starter	Alternator	Fuel Filter	Impeller	Impeller Kit	Thermostat
150EOZ	Kohler	—	—	—	—	—	—
3.5 CFZ	Kohler	—	—	23-7771(Var 2)	23-2003(SN 296898 & below)	—	23-3610
3.5 EFZ	Kohler	—	—	—	—	—	23-3610
4 CZ	Kohler	—	—	23-7771(Var 2)	23-2003(SN 296898 & below)	—	23-3610
4EF	Kohler	—	—	23-7762	23-2004	23-3314	23-3608
4EFCD	Kohler	—	—	—	—	—	—
4EFKD	Kohler	—	—	—	—	—	—
4 ESZ	Kohler	—	—	—	—	—	23-3610
5 CFZ	Kohler	—	—	23-7771(Var 2)	23-2003(SN 296898 & below)	—	23-3610
5ECD	Kohler	—	—	—	23-2004	23-3314	—
5 EFZ	Kohler	—	—	23-7762	—	—	23-3610
5EKD	Kohler	—	—	—	—	—	—
5E	Kohler	—	—	23-7762	23-2004	23-3314	23-3608
6EF	Kohler	—	—	23-7762	23-2004	23-3314	23-3608
6EFCD	Kohler	—	—	—	23-2004	23-3314	—
6EFKD	Kohler	—	—	—	—	—	—
6.5 CZ	Kohler	—	—	23-7771(Var 2)	23-2003(SN 296898 & below)	—	23-3610
6.5 ESZ	Kohler	—	—	23-7762	—	—	23-3610
7.3E	Kohler	—	—	23-7762	23-2004	23-3314	23-3608
7.3ECD	Kohler	—	—	—	23-2004	23-3314	—
7.3EKD	Kohler	—	—	—	—	—	—
8E	Kohler	—	—	23-7762(GR4 Ver), 23-7771(Var 2) Inline	23-2002 (296899 & Up), 23-2003 (296898 & below)	23-3303 (SN 296899 & Up), 23-3304 (SN 296898 & below)	23-3608
8EFKD	Kohler	—	—	—	—	—	—
9EFGD	Kohler	—	—	23-7780	—	—	—
10E	Kohler	—	—	23-7762(GR4 Ver), 23-7771(Var 2) Inline	23-2002 (296899 & Up), 23-2003 (296898 & below)	23-3303 (SN 296899 & Up), 23-3304 (SN 296898 & below)	23-3608
10EG	Kohler	—	—	23-7780	—	—	—
10EGD	Kohler	—	—	23-7780	—	—	—
10EKD	Kohler	—	—	—	—	—	—
11EFGD	Kohler	—	—	—	—	—	—
12.5E	Kohler	—	—	23-7762(GR4 Ver), 23-7771(Var 2) Inline	23-2002 (296899 & Up), 23-2003 (296898 & below)	23-3303 (SN 296899 & Up), 23-3304 (SN 296898 & below)	23-3608
12.5CF	Kohler	—	—	—	23-2002 (296899 & Up), 23-2003 (296898 & below)	23-3303 (SN 296899 & Up), 23-3304 (SN 296898 & below)	23-3608
13EG	Kohler	—	—	23-7780	—	—	—
13EGZ	Kohler	—	—	23-7780	—	—	—
13EGD	Kohler	—	—	—	—	—	—
15C	Kohler	—	—	—	23-2002	23-3303	23-3608
15EG	Kohler	—	—	23-7780	—	—	—
15EGD	Kohler	—	—	23-7780	—	—	—
15EGZ	Kohler	—	—	23-7780	—	—	—
16CF	Kohler	—	—	—	23-2002	23-3303	23-3608
17.5CF	Kohler	—	—	—	—	—	—
20C	Kohler	—	—	—	23-2002	23-3303	23-3608
MDKAU	Onan	—	—	23-7760	—	—	—
MDKAV	Onan	—	—	23-7760	—	23-3300	—
MDKBG	Onan	—	—	23-7760	—	23-3300	—
MDKAW (Spacesaver)	Onan	—	—	23-7760	—	23-3300	—
MDKAZ	Onan	—	—	23-7760	—	23-3300	—
MDKBD	Onan	—	—	23-7760	—	23-3300	—
MDKBE	Onan	—	—	23-7760	—	23-3300	—
MDKBF	Onan	—	—	23-7760	—	23-3300	—
MDKBD (w/ Isolated Ground)	Onan	—	—	23-7760	—	23-3300	—
MDKBE (w/ Isolated Ground)	Onan	—	—	23-7760	—	23-3300	—
MDKBF (w/ Isolated Ground)	Onan	—	—	23-7760	—	23-3300	—

Thermostat Kit	Oil Filter	Air Filter	Thermostat Gasket	Anode	Carburetor Kit	Glow Plug	Temperature Sender	Oil Pressure Sender	Solenoid
—	—	—	—	—	—	—	—	—	—
23-3663	23-7823	23-1101	23-0809	—	—	—	—	—	—
—	23-7823	—	—	—	—	—	—	—	—
23-3663	23-7823	23-1101	23-0809	—	—	—	—	—	—
—	23-7821	—	—	23-6400	23-7202	—	—	—	—
—	—	—	—	—	—	—	—	—	—
—	—	—	—	—	—	—	—	—	—
—	23-7823	—	—	—	—	—	—	—	—
23-3663	23-7823	23-1101	23-0809	—	—	—	—	—	—
—	—	—	—	—	—	—	—	—	—
—	23-7823	—	—	—	—	—	—	—	—
—	—	—	—	—	—	—	—	—	—
—	23-7821	—	—	23-6400	23-7202	—	—	—	—
—	23-7821	—	—	23-6400	23-7202	—	—	—	—
—	—	—	—	—	—	—	—	—	—
—	—	—	—	—	—	—	—	—	—
23-3663	23-7823	23-1101	23-0809	—	—	—	—	—	—
—	23-7823	—	—	—	—	—	—	—	—
—	23-7821	—	—	23-6400	23-7202	—	—	—	—
—	—	—	—	—	—	—	—	—	—
—	—	—	—	—	—	—	—	—	—
23-3664	23-7803	—	23-0813	—	—	—	—	—	—
—	—	—	—	—	—	—	—	—	—
—	—	—	—	—	—	—	—	—	—
23-3664	23-7803	—	23-0813	—	—	—	—	—	—
23-3664	—	—	23-0813	—	—	—	—	—	—
—	—	—	—	—	—	—	—	—	—
—	—	—	—	—	—	—	—	—	—
—	—	—	—	—	—	—	—	—	—
23-3664	23-7803	—	23-0813	—	—	—	—	—	—
23-3664	23-7820	—	23-0813	—	—	—	—	—	—
23-3664	—	—	23-0813	—	—	—	—	—	—
23-3664	—	—	23-0813	—	—	—	—	—	—
—	—	—	—	—	—	—	—	—	—
23-3664	23-7820	—	23-0813	—	—	—	—	—	—
23-3664	—	—	23-0813	—	—	—	—	—	—
—	—	—	—	—	—	—	—	—	—
23-3664	—	—	23-0813	—	—	—	—	—	—
23-3664	23-7820	—	23-0813	—	—	—	—	—	—
—	—	—	—	—	—	—	—	—	—
23-3664	23-7820	—	23-0813	—	—	—	—	—	—
—	23-7804	—	—	—	—	—	—	—	—
—	23-7842	—	—	23-6401	—	—	—	—	—
—	23-7842	—	—	23-6401	—	—	—	—	—
—	23-7842	—	—	23-6401	—	—	—	—	—
—	23-7842	—	—	23-6401	—	—	—	—	—
—	23-7840	—	—	23-6401	—	—	—	—	—
—	23-7840	—	—	23-6401	—	—	—	—	—
—	23-7840	—	—	23-6401	—	—	—	—	—
—	23-7840	—	—	23-6401	—	—	—	—	—
—	23-7840	—	—	23-6401	—	—	—	—	—
—	23-7840	—	—	23-6401	—	—	—	—	—
—	23-7840	—	—	23-6401	—	—	—	—	—
—	23-7840	—	—	23-6401	—	—	—	—	—
—	23-7840	—	—	23-6401	—	—	—	—	—
—	23-7840	—	—	23-6401	—	—	—	—	—

Model	OEM	Starter	Alternator	Fuel Filter	Impeller	Impeller Kit	Thermostat
MDKBH	Onan	—	—	—	—	—	—
MDKBK	Onan	—	—	—	23-2000	23-3310	—
MDKBL	Onan	—	—	—	23-2000	23-3310	—
MDKBM	Onan	—	—	—	23-2000	23-3310	—
MDKBN	Onan	—	—	—	23-2000	23-3310	—
MDKBP	Onan	—	—	—	—	—	—
MDKBR	Onan	—	—	—	—	—	—
MDKBS	Onan	—	—	—	—	—	—
MDKBV	Onan	—	—	—	—	—	—
MDKBT	Onan	—	—	—	—	—	—
MDKBU	Onan	—	—	—	—	—	—
MDDCA	Onan	—	—	—	—	23-3309	—
MDDCB	Onan	—	—	—	—	23-3309	—
MDDCC	Onan	—	—	—	—	23-3309	—
MDDCF	Onan	—	—	—	—	23-3309	—
MDDCG	Onan	—	—	—	—	23-3309	—
MDDCD	Onan	—	—	—	—	23-3309	—
MDDCE	Onan	—	—	—	—	23-3309	—
MDDCH	Onan	—	—	—	—	23-3309	—
MDDCJ	Onan	—	—	—	—	23-3309	—
MDJA	Onan	—	—	23-7750 (Spec A-R)	—	—	23-3606
MDJB	Onan	—	—	23-7750 (Spec A-R)	—	—	23-3606
MDJC	Onan	—	—	23-7750 (Spec A-R)	—	—	23-3606
MDJE	Onan	—	—	23-7750 (Spec A)	—	—	23-3606
MDJF	Onan	—	—	23-7750 (Spec A)	—	—	23-3606
MJA	Onan	—	—	—	—	—	23-3606
MJB	Onan	—	—	—	—	—	23-3606
MJC	Onan	—	—	—	—	—	23-3606
MDKAD/E/F	Onan	—	—	23-7760	—	—	—
MDKAL/A/B	Onan	—	—	—	23-2000	23-3310	—
AGTPM 4	Fischer Panda	—	—	—	23-2001	23-3311	—
PMS 4	Fischer Panda	—	—	—	23-2001	23-3311	—
PMS 8 Mini	Fischer Panda	—	—	—	23-2001	23-3305	—
PMS 8 DP	Fischer Panda	—	—	—	23-2001	23-3305	—
PMS 4200	Fischer Panda	—	—	—	23-2001	23-3305	—
PMS 6500	Fischer Panda	—	—	—	23-2001	23-3305	—
PMS 12 DP	Fischer Panda	—	—	—	23-2001	23-3305	—
PMS 12 Mini	Fischer Panda	—	—	—	23-2001	23-3305	—
PMS 15	Fischer Panda	—	—	—	—	23-3312	—
PMS 16 DP	Fischer Panda	—	—	—	—	23-3312	—
PMS 20	Fischer Panda	—	—	—	—	23-3312	—
PMS 22	Fischer Panda	—	—	—	—	23-3312	—
PMS 25	Fischer Panda	—	—	—	—	23-3312	—
PMS 30	Fischer Panda	—	—	—	—	23-3312	—
PMS 40	Fischer Panda	—	—	—	—	23-3312	—
PMS 50	Fischer Panda	—	—	—	—	23-3312	—
M673LD3	Northern Lights	—	—	—	23-2005	23-3315	—
M673L3	Northern Lights	—	—	—	23-2005	23-3315	—
M673LD2	Northern Lights	—	—	—	23-2005	23-3315	—
M673L2	Northern Lights	—	—	—	23-2005	23-3315	—
M753	Northern Lights	—	—	—	—	—	—
M753G	Northern Lights	—	—	—	—	—	—
M753K	Northern Lights	—	—	—	—	—	—
M753W	Northern Lights	—	—	—	—	—	—
M753w2	Northern Lights	—	—	—	—	—	—
M773L	Northern Lights	—	—	—	—	—	—
M773LW2	Northern Lights	—	—	—	—	—	—
M773LW3: 9/7Kw	Northern Lights	—	—	—	—	—	—
M843	Northern Lights	—	—	—	—	—	—

Model	OEM	Starter	Alternator	Fuel Filter	Impeller	Impeller Kit	Thermostat
M843N	Northern Lights	—	—	—	—	—	—
M843NK	Northern Lights	—	—	—	—	—	—
M843NK2	Northern Lights	—	—	—	—	—	—
M843NW	Northern Lights	—	—	—	—	—	—
M843NW2	Northern Lights	—	—	—	—	—	—
M843NW3	Northern Lights	—	—	—	—	—	—
M844	Northern Lights	—	—	—	—	—	—
M844K	Northern Lights	—	—	—	—	—	—
M844L	Northern Lights	—	—	—	—	—	—
M844LK	Northern Lights	—	—	—	—	—	—
M844LW	Northern Lights	—	—	—	—	—	—
M844LW2	Northern Lights	—	—	—	—	—	—
M844W	Northern Lights	—	—	—	—	—	—
M844W2	Northern Lights	—	—	—	—	—	—
M844W3: 16/12KW	Northern Lights	—	—	—	—	—	—
M844LW3: 20/16Kw	Northern Lights	—	—	—	—	—	—
M844NK2	Northern Lights	—	—	—	—	—	—
M844LK2	Northern Lights	—	—	—	—	—	—
M844NW2	Northern Lights	—	—	—	—	—	—
M844NW3	Northern Lights	—	—	—	—	—	—
ML844	Northern Lights	—	—	—	—	—	—
ML844K	Northern Lights	—	—	—	—	—	—
ML844L	Northern Lights	—	—	—	—	—	—
ML844LK	Northern Lights	—	—	—	—	—	—
M864K	Northern Lights	—	—	—	—	—	—
M864W	Northern Lights	—	—	—	—	—	—
M864W3: 25/20Kw	Northern Lights	—	—	—	—	—	—
M16C	Northern Lights	—	—	—	—	—	—
M20CL	Northern Lights	—	—	—	—	—	—
M20CR	Northern Lights	—	—	—	—	—	—
IS 2.5	Mase					23-3311	
IS 4.0	Mase					23-3311	
IS 4.7	Mase					23-3311	
IS 7.1	Mase					23-3311	
IS 13.2	Mase						
IS 8.1	Mase			23-7751			
IS 10.2	Mase					23-3312	
IS 14.0	Mase					23-3312	
IS 15.6T	Mase						
IS 19.0	Mase					23-3312	
IS 23.1T	Mase					23-3312	
IS 28.0	Mase						
IS 31.0	Mase						
IS 42.0	Mase						



FUEL WATER SEPARATORS

Sierra fuel water separators remove over 99.8% of emulsified water from your gasoline. Sierra's 10 micron filters are over 90% efficient at removing particles as small as 10 micron. All filters flow @ 90 GPH to feed even the hungriest motor. Sierra 10 micron filters are recommended to prevent damage to sensitive inboard, sterndrive and outboard fuel injection systems.



1 1/16" - 16 thread size

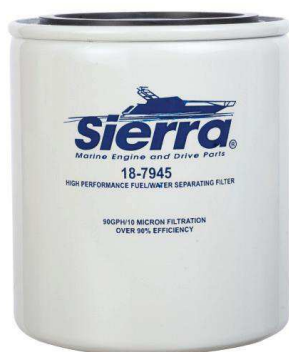

Includes Bracket, Filter & 2 pipe plugs*

3/8" Pipe Plugs - 18-4264
1/4" Pipe Plugs - 18-4256

* Display Packaged

- UNIVERSAL DESIGN -

FUEL WATER SEPARATOR BRACKETS

Part No.	Thread	Material	Replaces
18-7777	1/4"	Stainless Steel	Yamaha MAR-FLTHD-SS-12
18-7776	3/8"	Stainless Steel	
18-7853-1	1/4"	Aluminum	Mercury 89876A3, 89876, 55481 Yamaha MAR-FLTHD-AL-12
18-7775	3/8"	Aluminum	

FILTERS

Part No.	Description	Micron Rating	Replaces
18-7944	Short - 3.875"	10	Mercury - 35-807172, 35-802893Q, 35-806771, 35-8053691, 35-805369, 35-604941, 35-60494, 35-57250, 35-55501, 35-52456
18-7945	Long - 4.35"	10	Mercury - 35-802893Q, 35-806771, 35-8053691, 35-805369, 35-604941, 35-60494, 35-57250, 35-55501, 35-52456 Yamaha - ABB-FUELF-IL-TR
18-7866	High Capacity - 6"	10	Yamaha - MAR-FUELF-IL-TR
18-7967	V6 EFI 1995-Earlier with sensor (black)	10	Mercury - 35-18458Q3, 35-18458A3, 35-18458A2, 35-17808A1, 35-14571A1
18-7968	V6 EFI 1996-Up with sensor (blue)	10	Mercury - 35-18458Q4, 35-184585
18-7844	Short - 3.875"	21	Mercury - 35-807172, 35-802893Q
18-7845	Long - 4.35"	21	Mercury - 35-806771, 35-8053691, 35-60494A4, 35-604941, 35-57250, 35-55501 Yamaha - ABB-FUELF-IL-TR
18-79911	Long - 8.5"	10	Mercury - 35-8M0079962

FUEL WATER SEPARATOR COVERS

Part No.	Description
18-8953	Fits: Yamaha mini-10 size filter
18-8954	Fits: Yamaha 18-7866 sized filter
18-8955	Fits: 18-7944 & 18-7945 sized filter

FUEL WATER SEPARATOR KITS

Part No.	Kit Type	Micron Rating	Contents	Replaces
18-79912	1/4" Aluminum (Tall Filter)	10	1 - 18-79911 & 1 - 18-7853-1	Mercury - 35-8M0082290
18-7983-1	1/4" Aluminum (Short Filter)	10	1 - 18-7944 & 1 - 18-7853-1	Mercury - 35-802893A4, Q4, 35-60494A4, 35-807172A4, 35-60494A1, 35-57250A1, 35-55501A1, 35-52456A1
18-7982-1	1/4" Aluminum (Tall Filter)	10	1 - 18-7945 & 1 - 18-7853-1	
18-7966-1	1/4" Aluminum (High Capacity Filter)	10	1 - 18-7866 & 1 - 18-7853-1	Yamaha - MAR-SEPAR-AT-OR
18-7986-1	3/8" Aluminum (Tall Filter)	10	1 - 18-7945 & 1 - 18-7775	
18-7984-1	1/4" Stainless Steel (Tall Filter)	10	1 - 18-7945 & 1 - 18-7777	Yamaha - MAR-SPRTR-HD-SS
18-7985-1	3/8" Stainless Steel (Tall Filter)	10	1 - 18-7945 & 1 - 18-7776	
18-7848-1	1/4" Aluminum (Short Filter)	21	1 - 18-7844 & 1 - 18-7853-1	Mercury - 35-807172A4, Q4, 35-60494A4, 35-805369A4, 35-57250A1, 35-55501A1, 35-52456A1, 35-60494A1, 52444
18-7852-1	1/4" Aluminum (Tall Filter)	21	1 - 18-7845 & 1 - 18-7853-1	Yamaha - MAR-SEPAR-AT-OR
18-7775-1	3/8" Aluminum (Tall Filter)	21	1 - 18-7845 & 1 - 18-7775	
18-7777-1	1/4" Stainless Steel (Tall Filter)	21	1 - 18-7845 & 1 - 18-7777	Yamaha - ABB-SPRTR-HD-SS
18-7776-1	3/8" Stainless Steel (Tall Filter)	21	1 - 18-7845 & 1 - 18-7776	



FUEL WATER SEPARATOR KITS - BONUS PACK CONTAINS SPARE FILTER

Part No.	Kit Type	Micron Rating	Contents
18-7983-2	1/4" Aluminum	10	2 - 18-7944 & 1 - 18-7853-1
18-7982-2	1/4" Aluminum	10	2 - 18-7945 & 1 - 18-7853-1
18-7848-2	1/4" Aluminum	21	2 - 18-7844 & 1 - 18-7853-1
18-7852-2	1/4" Aluminum	21	2 - 18-7845 & 1 - 18-7853-1

*Each kit contains 2 brass pipe plugs

SIERRA AquaVue™ & METAL COLLECTION BOWL FUEL WATER SEPARATOR KITS

Sierra AquaVue™ and metal collection bowl separator filters allow water to be drained from the filter to extend service life. Use the AquaVue™ collection bowl for outboard, above deck installations. USCG regulations require the use of the flame resistant metal collection bowl below deck.



1 1/16" - 16 thread size



*Each kit contains 2 brass pipe plugs

10 MICRON FILTER KITS WITH COLLECTION BOWLS

Part No.	Kit Type	Contents
18-7932-1	1/4" Aluminum w/ AquaVue™ collection bowl	1 - 18-7919 & 1 - 18-7853-1, 1 - 18-7922-1
18-7951	1/4" Aluminum w/ metal collection bowl	1 - 18-7919 & 1 - 18-7853-1, 1 - 18-7924
18-7937-1	1/4" Stainless Steel w/ AquaVue™ collection bowl	1 - 18-7919 & 1 - 18-7777, 1 - 18-7922-1
18-7938	1/4" Stainless Steel w/ metal collection bowl	1 - 18-7919 & 1 - 18-7777, 1 - 18-7924

REPLACEMENT BOWLS

Part No.	Description	Replaces
18-7922-1	AquaVue™ Collection Bowl	Suzuki 99105-20004-BWL
18-7924	Metal Collection Bowl	Yamaha MAR-10171-00-10

REPLACEMENT ELEMENTS & ELEMENT BOWL ASSEMBLIES

Part No.	Description	Replaces
18-7919	Spin on replacement 10 Micron, 7 1/2" tall	Mercury 35-809097, 35-8M0103095 Yamaha MAR-24563-00-00 Racor S3213
18-7928-1	Filter & AquaVue™ Collection Bowl Mercury/Yamaha Style Contains: 18-7919, 18-7922-1	Racor B32013
18-7929	Filter & Metal Collection Bowl Mercury/Yamaha Style Contains: 18-7919, 18-7924	Mercury 35-809100 Racor B32020MAM
18-0179	Bowl O-Ring Standard Metal and AquaVue™ Collection Bowl	Racor RK22244
18-7394	Bowl O-Ring Mini 10 AquaVue™ Collection Bowl	Racor RK10012
18-9884	Bowl Wrench	Racor RK22628

3/8" Pipe Plugs - 18-4264
1/4" Pipe Plugs - 18-4256

• Display Packaged

COMPACT BRACKET & SEPARATOR KIT FOR OUTBOARDS UP TO 115HP 10 MICRON FILTRATION FOR SMALL OUTBOARD MOTORS



18-7965-1 10 MICRON COMPACT SEPARATOR KIT

Replaces: Yamaha
MAR-MINIF-LT-AS

Contains:

- 1 - 18-7774 bracket
- 1 - 18-7865 filter



18-7774 COMPACT ALUMINUM BRACKET

13/16" - 18 thread size



18-7865 REPLACEMENT FILTER

Replaces: Yamaha MAR-MINIF-IL-TR



18-79906 FUEL FILTER

For: Racor style Mini-10
Bowl-style filter

Use with drain bowls 18-7987 & 18-7988



18-7987 AquaVue™ BOWL

For: Racor style Mini-10



18-7988 COLLECTION BOWL

For: Racor style Mini-10

OMC REPLACEMENT FUEL FILTERS



18-7920 10 MICRON REPLACEMENT FILTER

Replaces: OMC 771839,
Racor S3214, Mercury 35-809099
1" - 12 thread size



18-7941-1 FILTER & AquaVue™ BOWL

OMC style
Contains: 18-7920, 18-7922-1



18-7943 FILTER & METAL BOWL

OMC style
Contains: 18-7920, 18-7924



18-7946 10 MICRON REPLACEMENT FILTER

Replaces: OMC 502905
OMC thread



18-7846 21 MICRON REPLACEMENT FILTER

Replaces: OMC 502905
OMC thread



18-7930 FUEL FILTER

Replaces: OMC 173326
For: 1977-83 Fuel system with add-on filter kit

VOLVO STYLE FUEL WATER SEPARATOR KITS



18-8149 HIGH CAPACITY FUEL WATER SEPARATING FILTER 10 MICRON

Replaces: Volvo 3847644
For use with side-by-side fuel pump applications.



18-7778 VOLVO ALUMINUM REPLACEMENT BRACKET

Replaces: Volvo 3850861
13/16" - 18 thread size

10 MICRON REPLACEMENT FILTERS

Part No.	Description	Replaces
18-7989	Volvo SX/EFI	Volvo 3851218-2, 3852413, 3862228
	Cobra EFI	OMC 502906

21 MICRON REPLACEMENT FILTERS

Part No.	Description	Replaces
18-7789	Volvo SX/EFI	Volvo 3851218-2, 3852413
	Cobra EFI	OMC 502906

REPLACEMENT ELEMENTS & ASSEMBLIES FOR RACOR FILTER KITS



• Display Packaged

ELEMENT & BOWL KITS		
PART #	DESCRIPTION	CONTAINS
18-7969 •	Filter & Metal Bowl	18-7948, 18-7924
18-7994-1 •	Filter & AquaVue™ Bowl	18-7948, 18-7922-1
REPLACEMENT ELEMENT ONLY		
PART #	ELEMENT FOR RACOR	REPLACES
18-7947	120RRAC01 (Uses Mini Bowl below)	Honda 17670-ZW1-030GH Racor S3240 Suzuki 99105-20006
18-7948	320RRAC01 (1" - 14 thread size) (short filter)	Honda 17670-ZW1-801AH Mercury 35-886638 Racor S3227 Suzuki 99105-20005
18-7949	660RRAC02 (1" - 14 thread size) (tall filter)	Racor S3232
REPLACEMENT BOWL		
PART #	DESCRIPTION	REPLACES
18-7987	AquaVue™ Mini Bowl	Racor RK10222 Suzuki 99105-20006-BWL
18-7988	Mini Metal Bowl	-
BOWL WRENCH		
18-9884	Bowl Wrench	Racor RK22628

DIESEL FUEL FILTERS

<p>20 MICRON</p> <p>18-7931 Replaces: Detroit Diesel 5574508 For: 8V-92, 8V-71</p>	<p>20 MICRON</p> <p>18-7934 Replaces: Cerlist Diesel 1512904 Model M</p>	<p>20 MICRON</p> <p>18-7935 Replaces: Fram CCS 1136 Fram FCS 1136 Filter Bracket</p>	<p>20 MICRON</p> <p>18-7970 Replaces: Cerlist Diesel 1512903 Model 3M</p>
<p>18-79960 FUEL FILTER ELEMENT Replaces: Yanmar 104500-55710 Fits: All GM Series, YM Series, HM Series, QM Series</p>	<p>20 MICRON</p> <p>18-7858 Replaces: Volvo 858201 For: CAV Type Unit For: AQ120B, 125A, B, 131A, 140A, 145A, B, 151, BB, 140, 145A</p>	<p>20 MICRON</p> <p>18-7942 Replaces: Volvo 466987, 3825133 For: MD100A, TMD100A, MD100B, MD120A, TMD120A, TAMD120A, MD120B, TMD120B, TAMD120B, MD70B, TMD70B, TAMD70B, THAMD70B, AQAD70B, MD70C, TMD70C, TAMD70C, AQD70C, TAMD60A, TAMD60B, TAMD60C, D5/D7 MARINE GENSET, D5A-T, D5A-TA, D7A-T, D7A-TA, D7C-TA, D63 MARINE, D71/73 MARINE, KAD32P, TAMD42WJ, KAD43P/44P/300, KAMD43P/44P/300, TAMD103A, TAMD61A, TAMD62A, TAMD71A, TAMD72A, TAMD72P, TAMD72WJ, TAMD74, TAMD75 MARINE, TMD102A, TAMD102A, TAMD102D, TMD122A, TAMD122A, TAMD122P, TMD31L, TAMD31P/L/M/S, AD31P/L, TMD41L, TAMD41P/L/M/H</p>	
<p>18-7873 Replaces: Mercruiser 35-808275 For models: D7.3/270 Bravo & MIE Diesel Engines (1994-96)</p>	<p>18-8124 Replaces: Volvo 829913 For: 2001, 2001B, 2002, 2002B, 2003, 2003B/T/TB, AQD2B, MD11C/D, MD17C/D, MD1B, MD2B, MD3B, MD5A/B/C, MD7/B</p>	<p>18-8125 Replaces: Volvo 3583443 For: D4-180i-B, D4-180i-C, D4-210A-A, D4-210A-B, D4-210i-A, D4-210i-B, D4-225A-B, D4-225A-C, D4-225i-C, D4-260A-A, D4-260A-B, D4-260A-C, D4-260D-B, D4-260D-C, D4-260i-A, D4-260i-B, D4-260i-C, D4-300A-A, D4-300A-C, D4-300D-A, D4-300D-C, D4-300i-A, D4-300i-C, D6-280A-A, D6-280A-B, D6-280i-A, D6-280i-B, D6-310A-A, D6-310A-B, D6-310D-A, D6-310D-B, D6-310i-A, D6-310i-B, D6-330A-B, D6-330A-C, D6-330D-B, D6-330D-C, D6-330i-B, D6-330i-C, D6-350A-A, D6-350A-B, D6-370A-B, D6-370A-C, D6-370D-A, D6-370D-B, D6-370D-C, D6-370i-A, D6-370i-B, D6-370i-C, D6-435D-A, D6-435D-C, D6-435i-A, D6-435i-C</p>	<p>18-8126 Replaces: Volvo 861477 For: D1-13 A, D1-13 B, D1-20 A, D1-20 B, D1-30 A, D1-30 B, D2-40 A, D2-40 B, D2-55 A, D2-55 B, D2-55 C, D2-55 D, D2-55 E, D2-55F, D2-75 A, D2-75 B, D2-75 C, D2-75F, MD2010A, MD2010B, MD2020A, MD2020B, MD2030A, MD2030B, MD2040A, MD2040B</p>

FUEL FILTERS



20 MICRON



FUEL FILTER

18-7723

Fits: 1/4" and 5/16" hose

18-7724

Fits: 3/8" and 7/16" hose



18-7828-1

FUEL FILTER

Small Capacity for 1/4" Fuel Line



FUEL FILTERS

PART #	REPLACES	APPLICATION
18-7829	Mercury 35-16494, 35-816296, T, Q, 35-816296K03	1/4" Large Cap. (For 1/4" Fuel Line)
18-7830	Mercury 35-164941, 35-816296 1, 35-816296T1, Q2, 35-8162961, 35-816396Q1, 35-816296B2, 35-816296B1, 35-134301	5/16"
18-7831	Mercury 802128A1 Johnson/Evinrude 398319	3/8"



18-7856-1

FUEL FILTER

Replaces: A.C. Delco GF-61

For: 5/16" Fuel Line



18-7857-1

FUEL FILTER

Replaces: A.C. Delco GF-61P

For: 3/8" Fuel Line

18-7790

FUEL FILTER KIT

Complete Kit Contains: Housing, Replaceable Element & Fittings for 1/4", 5/16", & 3/8" Fuel Lines



18-7791

FUEL FILTER ELEMENT

Replacement element for

18-7790 filter kit

18-9884

BOWL WRENCH

Replaces: Racor RK22628

Fits: Sierra, Racor and other aftermarket filter bowls



PRIMER BULBS



- Meets current EPA regulations in effect 1/1/2011 of 15 g/m2/24 hrs.
- Both EPA/CARB certified
- Utilizes Fluoroelastomer (FKM) material for traditional look and operation.
- 7 1/2" overall length including barbs



18-8002EP-1

PRIMER BULB ASSEMBLY

1/4" I.D.



18-8004EP-1

18-8004-10EP-1

PRIMER BULB ASSEMBLY

Replaces: Mercury 89396A38, 89396Q38

Johnson/Evinrude 174511

5/16" I.D.



18-8005EP-1

18-8005-10EP-1

PRIMER BULB ASSEMBLY

Replaces: Mercury 13330A3, 13330Q,

Johnson/Evinrude 174512

3/8" I.D.

SILVERADO 4000 COMPLETE FUEL LINE ASSEMBLIES

DISPLAY PACKAGE



- Premium Rubber Fuel Line
 - Polyester braid
 - Weather resistant CPE cover
 - Flexible THV barrier layer
- Updated packaging
- Best hose on the market-resists kinking & easy to clamp.



CHRYSLER / FORCE

8' LENGTH COMPLETE FUEL LINE ASSEMBLIES

3/8"
FUEL LINE ASSEMBLY

18-8011EP-2 SILVERADO 4000 Premium

OE# FS409752



*



18-8071
TANK
CONNECTOR
(SOLD SEPARATELY)



18-8005EP-1
PRIMER
BULB



18-8062
FUEL
CONNECTOR



*

FUEL LINE ASSEMBLY COMPONENTS

HONDA

9' LENGTH COMPLETE FUEL LINE ASSEMBLIES

3/8"
FUEL LINE ASSEMBLY

18-81042EP-2 SILVERADO 4000 Premium OE# 17700-ZW9-010
17700-ZW9-020



*



18-80400
TANK
CONNECTOR
(SOLD SEPARATELY)



18-80401
FUEL
CONNECTOR

18-8005EP-1
PRIMER
BULB

18-80403
FUEL
CONNECTOR



*

FUEL LINE ASSEMBLY COMPONENTS

Honda Fuel Application: 8, 9.9, 15, 25, 30, 40, 50, 75, 90, 115, 130 HP (2001-02)

* Tanks and Engines for picture purpose only.

JOHNSON / EVINRUDE

8' LENGTH COMPLETE FUEL LINE ASSEMBLIES

3/8" High Flow
FUEL LINE ASSEMBLY

18-8009EP-2 *SILVERADO 4000 Premium*

OE# 398549



18-8063
TANK
CONNECTOR
(SOLD SEPARATELY)



18-8092
FUEL
CONNECTOR



18-8005EP-1
PRIMER
BULB



18-8092
FUEL
CONNECTOR



FUEL LINE ASSEMBLY COMPONENTS

Fits: All V8, 1984 & later V6, 1985 & later 120 HP, 140 HP outboards, 2 HP (1 cyl.) - 75 HP (3 cyl.) (1976-02)

3/8"
FUEL LINE ASSEMBLY

18-8014EP-2 *SILVERADO 4000 Premium*

OE# 174509



18-8074
HOSE BARB
(SOLD SEPARATELY)



18-8005EP-1
PRIMER
BULB



18-8092
FUEL
CONNECTOR



FUEL LINE ASSEMBLY COMPONENTS

Fits: All V6 & V8 (1976-02)

MERCURY / MARINER

8' LENGTH COMPLETE FUEL LINE ASSEMBLIES

3/8"
FUEL LINE ASSEMBLY

18-8010EP-2 *SILVERADO 4000 Premium*



18-8068
18-8082
TANK
CONNECTOR
(SOLD SEPARATELY)



18-8084
FUEL
CONNECTOR



18-8005EP-1
PRIMER
BULB



18-8083
FUEL
CONNECTOR



FUEL LINE ASSEMBLY COMPONENTS

3/8"
FUEL LINE ASSEMBLY

18-8012EP-2 *SILVERADO 4000 Premium*

OE# 32-858114Q08,
32-858114K08



18-8074
HOSE BARB



18-8005EP-1
PRIMER
BULB



18-8073
HOSE BARB



FUEL LINE ASSEMBLY COMPONENTS

Has 1/8" NPT threaded fitting on engine end and 1/4" NPT threaded fitting on the tank end. Primer bulb is included in this 8ft. (2.44 m) assembly. Fits various applications using the older style twist type disconnects at the engine end and either a bayonet or thread-in fitting on the tank end.

MERCURY / MARINER (Cont.)

3/8" FUEL LINE ASSEMBLY

18-8024EP-2 SILVERADO 4000 Premium

OE# 32-858104Q08,
32-858104K08



*

18-8074
HOSE BARB



18-8005EP-1
PRIMER
BULB

18-8076
FUEL
CONNECTOR



*

FUEL LINE ASSEMBLY COMPONENTS

Has standard quick connect type fitting on engine end and 1/4" NPT threaded fitting on the tank end. Primer bulb is included in this 8 ft. (2.44 m) assembly. Fits Force 40 HP and larger (1993 & Newer), Force 9.9/15/25HP (1998), and all Mercury/Mariner outboards using clip on type disconnect at engine ends and a tank with threaded fuel pickup fitting.

3/8" FUEL LINE ASSEMBLY

18-8025EP-2 SILVERADO 4000 Premium

OE# 32-858105Q08,
32-858105K08



*

18-8068
18-8082
TANK
CONNECTOR
(SOLD SEPARATELY)



18-8084
FUEL
CONNECTOR



18-8005EP-1
PRIMER
BULB

18-8076
FUEL
CONNECTOR



*

FUEL LINE ASSEMBLY COMPONENTS

Has standard quick connect type fitting on engine end and bayonet style fitting on the tank end. Primer bulb is included in this 8 ft. (2.44 m) assembly. Fits Force 40 HP and larger (1993 & Newer), Force 9.9/15/25HP (1998), and all Mercury/Mariner outboards using clip-on type disconnect at the engine end and an older style tank with bayonet type connection.

3/8" FUEL LINE ASSEMBLY

18-8016EP-2 SILVERADO 4000 Premium

OE# 32-858109Q12,
32-858109K12



*

18-80402
TANK
CONNECTOR
(SOLD SEPARATELY)



18-8091
FUEL
CONNECTOR



18-8005EP-1
PRIMER
BULB

18-8076
FUEL
CONNECTOR



*

FUEL LINE ASSEMBLY COMPONENTS

Has double sealed quick connect type fitting on tank end and clip-on type quick connect on engine end. Primer bulb is included in this 8ft. (2.44m) assembly. Fits Force 40 HP and larger (1993 & Newer), Force 9.9/15/25HP (1998) and all Mercury Mariner outboards using clip-on type disconnects at both tank and engine ends



* Tanks and Engines for picture purpose only.

YAMAHA

8' LENGTH COMPLETE FUEL LINE ASSEMBLIES

3/8"
FUEL LINE ASSEMBLY

18-8017EP-2 *SILVERADO 4000 Premium*

OE# 6YL-24306-60-00



18-8076
FUEL
CONNECTOR

18-8005EP-1
PRIMER
BULB

18-8076
FUEL
CONNECTOR



FUEL LINE ASSEMBLY COMPONENTS
Fits: F75-F250 and 115-300 HP

UNIVERSAL

8' LENGTH FUEL LINE ASSEMBLIES

5/16"
FUEL LINE ASSEMBLY

18-8013EP-2 *SILVERADO 4000 Premium*



18-8004EP-1
PRIMER
BULB



FUEL LINE ASSEMBLY COMPONENTS

3/8"
FUEL LINE ASSEMBLY

18-8015EP-2 *SILVERADO 4000 Premium*



18-8005EP-1
PRIMER
BULB



FUEL LINE ASSEMBLY COMPONENTS

12' LENGTH COMPLETE FUEL LINE ASSEMBLIES

5/16"
FUEL LINE ASSEMBLY

18-8032EP-2 *SILVERADO 4000 Premium*



18-8004EP-1
PRIMER
BULB



FUEL LINE ASSEMBLY COMPONENTS



HOSE BARBS

HOSE BARB APPLICATION

Part #	Mercury O.E. #	OMC O.E. #	Barb	NPT	Conn. Type
18-8041	—	—	5/8"	3/8"	Male
18-8042	—	—	1/4"	1/4"	Male
18-8043	—	—	1/4"	1/8"	Male
18-8054	22-63186	—	5/16"	1/8"	Male
18-8055	22-63187	173311	5/16"	1/4"	Male
18-8073	—	—	3/8"	1/8"	Male
18-8074	—	173312	3/8"	1/4"	Male
18-8093	—	—	1/4"	1/4"	Female
18-8094	—	—	5/16"	1/4"	Female
18-8095	—	—	3/8"	1/4"	Female
18-8108	—	—	3/8"	3/8"	Male
18-8109	—	—	5/16"	3/8"	Male



**18-8045
REDUCING NIPPLE
FITTING**
1/8" x 1/4" NPT HEX



**18-4256
PIPE PLUG**
1/4" Threads



**18-4264
PIPE PLUG**
3/8" Threads



**18-8046
FUEL TANK ELBOW**
1/8" NPT x 1/4" NPT
90°



**18-8047
FUEL TANK ELBOW**
1/4" NPT Threads
90°



**18-8067
18-8110
18-8110-9**
Bulk Pack of 12 (18-8067)
FUEL ELBOW
3/8" Barb with
1/4" NPT Thread
90°



**18-1650
SHUT OFF VALVE**
3 way 1/4" FNPT Valve



**18-1651
SHUT OFF VALVE**
2 way 1/4" FNPT Male/Male
Shut off Valve



**18-1652
SHUT OFF VALVE**
2 way 1/4" FNPT Male/
Female Shut off Valve



**18-1653
SHUT OFF VALVE**
2 way 1/4" FNPT Female/
Female Shut off Valve



**18-1654
SHUT OFF VALVE**
4 way 1/4" FNPT Valve



**18-1655
SHUT OFF VALVE**
3 way 1/4" FNPT Valve w/ Detent



**18-1656
SHUT OFF VALVE**
3 way 3/8" FNPT Valve w/ Detent

PKG. OF 10



SNAPPER CLAMPS

PART #	O.E.	O.E. #	CLAMP RANGE	CLAMP SIZE
18-8020	Mercury J/E	54-41582-7 322652	.538 - .608	8
18-8021	J/E	911616	.597 - .665	10
18-8034	J/E	329654	.670 - .780	12
18-8200	J/E	322653	.360 - .406	2
18-8201	J/E	124249	.410 - .468	4
18-8202	J/E	322654	.475 - .536	6
18-8203	J/E	329653	.750 - .875	14
18-8204	J/E	324825	.875 - .975	19

FUEL LINE

- ★ Universal
- ★ Vinyl
- ★ 35 psi working pressure

*Not intended for diesel fuel



10' Length	50' Roll	I.D.	O.D.
18-8150-10	18-8150	1/8"	1/4"
18-8151-10	18-8151	3/16"	5/16"
18-8152-10	18-8152	1/4"	3/8"

**FUEL LINE HOSE
SILVERADO 4000**

16-337-0566
5/16" I.D.



16-337-0386
3/8" I.D.



50' Reels ALCOHOL RESISTANT
SAE J1527 Type B1-15 and ISO 8469



**18-7598
PULL-START LOCK**



**18-7599
FUEL LOCK**
Protect your outboard from theft, disconnect fuel line and simply install fuel lock. Designed to fit clip on style fuel connectors. Fits: Johnson Evinrude, Mercury/Mariner, Yamaha and Honda.

① Priced per Package

FUEL LINE HOSE

MADE FROM AN ALCOHOL RESISTANT COMPOUND — 50' REELS



18-8048

BLEEDER HOSE

.090 I.D. x .220 O.D.
Similar to Mercury
32-99130122, 32-892024122

18-8050

.0625 I.D. x .190 O.D.
Similar to Mercury 32-9938779



18-8051

FUEL LINE HOSE

for OMC Pressurized Systems

Replaces: J/E 322656
(Double)



18-8052

FUEL LINE HOSE

3/16" I.D.
Non-Pressurized Systems

Replaces: J/E 122838

PRIMER BULBS

DISPLAY PACKAGE



- Nitrile construction.
- Manufactured for countries that do not need EPA/CARB compliancy.
- Resistant to alcohol laden fuels.



18-8002S

PRIMER BULB ASSEMBLY

1/4" I.D.



18-8004S

18-8004-10S

PRIMER BULB ASSEMBLY

Replaces: Mercury 89396A38, 89396Q38

Johnson/Evinrude 174511

5/16" I.D.



18-8005S

18-8005-10S

PRIMER BULB ASSEMBLY

Replaces: Mercury 13330A3, 13330Q,

Johnson/Evinrude 174512

3/8" I.D.

SILVERADO 4000 COMPLETE FUEL LINE ASSEMBLIES



DISPLAY PACKAGE

- Eight of the most popular numbers, utilizing the Silverado 4000 line and the non-domestic primer bulb.

- Updated packaging.



JOHNSON / EVINRUDE

8' LENGTH COMPLETE FUEL LINE ASSEMBLIES

3/8" High Flow
FUEL LINE ASSEMBLY

18-8009S-1 *SILVERADO 4000 Premium*

OE# 398549



18-8063
TANK
CONNECTOR
(SOLD SEPARATELY)

*



18-8092
FUEL
CONNECTOR

18-8005S
PRIMER
BULB

18-8092
FUEL
CONNECTOR



*

FUEL LINE ASSEMBLY COMPONENTS

Fits: All V8, 1984 & later V6, 1985 & later 120 HP, 140 HP outboards, 2 HP (1 cyl.) - 75 HP (3 cyl.) (1976-02)

8' LENGTH COMPLETE FUEL LINE ASSEMBLIES

3/8"
FUEL LINE ASSEMBLY

18-8014S-1 *SILVERADO 4000 Premium*

OE# 174509



18-8074
HOSE BARB
(SOLD SEPARATELY)

*



18-8005S
PRIMER
BULB

18-8092
FUEL
CONNECTOR



*

FUEL LINE ASSEMBLY COMPONENTS

Fits: All V6 & V8 (1976-02)

MERCURY / MARINER

8' LENGTH COMPLETE FUEL LINE ASSEMBLIES

8' LENGTH COMPLETE FUEL LINE ASSEMBLIES

3/8"
FUEL LINE ASSEMBLY

18-8016S-1 *SILVERADO 4000 Premium*

OE# 32-858109Q12,
32-858109K12



18-80402
TANK
CONNECTOR
(SOLD SEPARATELY)

*



18-8091
FUEL
CONNECTOR

18-8005S
PRIMER
BULB

18-8076
FUEL
CONNECTOR



*

FUEL LINE ASSEMBLY COMPONENTS

Has double sealed quick connect type fitting on tank end and clip-on type quick connect on engine end. Primer bulb is included in this 8ft. (2.44m) assembly.
Fits Force 40 HP and larger (1993 & Newer), Force 9.9/15/25HP (1998) and all Mercury Mariner outboards using clip-on type disconnects at both tank and engine ends

YAMAHA

8' LENGTH COMPLETE FUEL LINE ASSEMBLIES

3/8"
FUEL LINE ASSEMBLY

18-8017EP-2 *SILVERADO 4000 Premium*

OE# 6YL-24306-60-00



18-8077-1
TANK
CONNECTOR
(SOLD SEPARATELY)

*



18-8076
FUEL
CONNECTOR

18-8005EP-1
PRIMER
BULB

18-8076
FUEL
CONNECTOR



*

FUEL LINE ASSEMBLY COMPONENTS

Fits: F75-F250 and 115-300 HP

* Tanks and Engines for picture purpose only.

YAMAHA

8' LENGTH COMPLETE FUEL LINE ASSEMBLIES

3/8"
FUEL LINE ASSEMBLY

18-8017S-1 *SILVERADO 4000 Premium*

OE# 6YL-24306-60-00



*

*

FUEL LINE ASSEMBLY COMPONENTS
Fits: F75-F250 and 115-300 HP

UNIVERSAL

8' LENGTH FUEL LINE ASSEMBLIES

5/16"
FUEL LINE ASSEMBLY

18-8013S-1 *SILVERADO 4000 Premium*



18-8004S
PRIMER
BULB



*

*

FUEL LINE ASSEMBLY COMPONENTS

8' LENGTH FUEL LINE ASSEMBLIES

3/8"
FUEL LINE ASSEMBLY

18-8015S-1 *SILVERADO 4000 Premium*



18-8005S
PRIMER
BULB



*

*

FUEL LINE ASSEMBLY COMPONENTS

12' LENGTH COMPLETE FUEL LINE ASSEMBLIES

5/16"
FUEL LINE ASSEMBLY

18-8032S-1 *SILVERADO 4000 Premium*



18-8004S
PRIMER
BULB





















*

*

FUEL LINE ASSEMBLY COMPONENTS

* Tanks and Engines for picture purpose only.

 <p>18-7254 Replaces: Chrysler 3745414 Inlet: 3/8" - 24 • Outlet: 1/2" - 20 Use replacement gasket 18-0889</p>	 <p>18-7255 Replaces: Chrysler 3745415 Inlet: 3/8" - 24 • Outlet: 1/2" - 20</p>	 <p>18-7256 Replaces: Mercruiser 32722, Crusader 32722</p>
 <p>18-7260</p>	 <p>18-7264 Replaces: Chrysler 2279913, 1736073</p>	 <p>18-7265 Replaces: Chris-Craft 16.83-08758, FI8308762</p>
 <p>18-7266 Replaces: Ford DJL 9350A</p>	 <p>18-7267 Replaces: Mercruiser 62092, 62092T, 54552 OMC 982063 Gasket included</p>	 <p>18-7268 Replaces: OMC 981650 Volvo 3855276 Dual Diaphragm requires sight glass</p>
 <p>18-7270 Replaces: Crusader 21140 Gasket included</p>	 <p>18-7272 Replaces: Crusader 97039</p>	 <p>18-7274 Replaces: Mercruiser 86246, 86246A1, 78485, 71646 86246T OMC 509409</p>
 <p>18-7275 Replaces: Mercruiser 86247, 86247T, 86247A2, 78820, 63196, 46860 OMC 509410 Gasket included</p>	 <p>18-7278 Replaces: Mercruiser 86234A4, 86234A05, 86234A3, 86234, 77594, 71327, 47585 OMC 985602, 985603, 982240, 509395 Use replacement gasket 18-0889 Use replacement pump filter 18-7860</p>	 <p>18-7281 Replaces: Volvo 826493, 3855276 OMC 981650 Gasket included</p>
 <p>18-7282 Replaces: Mercruiser 42725A3, 861676T09 OMC 509407 Use replacement gasket 18-0889 Use replacement pump filter 18-7784</p>	 <p>18-7283 Replaces: Mercruiser 97401A2, 97401A8, 861678A1, 8M0058164, 97401 OMC 509404 Use replacement gasket 18-0889</p>	 <p>18-7284 Replaces: Mercruiser 41141A2, 862077A1 OMC 509408 Use replacement gasket 18-0889 Use replacement pump filter 18-7784</p>

ALL SIERRA FUEL PUMPS INCLUDE MOUNTING GASKET



18-7286
Replaces: Volvo 841161



18-7288-1
Replaces:
Mer cruiser 812454A1, 862048A1, 812454A3,
97399A2, 97399



18-7289
Replaces: OMC 982997
Gasket included



18-7258
Replaces: OMC 380986, GM 6414989



18-7326
ELECTRIC FUEL PUMP
• 8 psi, 25 gpm
Replaces: Mer cruiser 805656A2, 805656A6,
805656A5, 805025A2, 861155A6, 861155A5
OMC/Volvo 3858261, 3850809, 3854620, 3857986



18-7330
ELECTRIC FUEL PUMP
• 120 psi
Replaces: OMC/Volvo 3857650,
3855958, 988037, 3854280



18-7331
ELECTRIC FUEL PUMP
• 8 psi, 45 gpm
Replaces: OMC/Volvo 3858714,
3850810, 3857985



18-7332
ELECTRIC FUEL PUMP
Includes bracket and mounting hardware
43 GPH – 7 PSI Max. – 1/4 NPSF for 3/8 hose
– operates with both gasoline and diesel fuel - 24 Volt only



18-7333
ELECTRIC FUEL PUMP
UNIVERSAL
12V, 72GPH at 5.75 PSI, 1/4" NPSF
for 3/8" hose, for use with gasoline and diesel fuel.
OP72533 pressure safety switch recommended.

Year	Engine	Application	OE #	#'s Superseded from	Part #
Mer cruiser					
1996	262/4.3L	Low Pressure Supply Pump For F.I. System	805656A2		18-7326
1996	262/4.3L	Carbureted w/electric pump - Low PSI	805656A2		18-7326
1992-93	262/4.3L	Carbureted w/electric pump - Low PSI	805656A2		18-7326
OMC					
1992-94	262/4.3L	Low Pressure	3858261	385,080,938,508,103,000,000	18-7326
1997-98	350/5.7L, 454/7.4L, & 502/8.2L	Engines w/MPI - High Pressure	3857650		18-7330
1996	454/7.4L & 502/8.2L	Engines w/MPI - High Pressure	3857650		18-7330
1993-94	4.3L thru 5.8L	Low pressure electric fuel pump	3858261	3850809	18-7326
1992-1994	454/7.4L & 502/8.2L	GM Mark V Eng. - Low Pressure	3858714	3850810, 3857985	18-7331
Volvo-Penta					
1994-99	262/4.3L (HU-WT)	High Pressure pump	3857650		18-7330
1994-99	262/4.3L GL/GS (All)	Carbureted - Low Pressure	3858261	3850809	18-7326
1994-99	262/4.3L GI (HU-WT)	W.Elec. Pump - Low Pressure	3858261	3850809	18-7326
1994-99	454/7.4L & 502/8.2L (HU-WT)	Low pressure system	3858714	3850810, 3857985	18-7331
1993-99	350/5.7L, 454/7.4L, & 502/8.2L	Engines w/MPI - High Pressure	3857650		18-7330
1996-99	454/7.4L & 502/8.2L (HU-WT)	Engines w/MPI - High Pressure	3857650		18-7330
1994-99	5.0L thru 5.8L	Low pressure electric fuel pump	3858261	3850809	18-7326
1994-99	454/7.4L & 502/8.2L (HU-WT)	GM Mark V Eng. - Low Pressure	3858714	3850810, 3857985	18-7331
1992-93	454/7.4L	GM Mark V Eng. - Low Pressure	3858714	3850810, 3857985	18-7331

ALL SIERRA FUEL PUMPS INCLUDE MOUNTING GASKET

Many fuel pumps are often used on similar engines. In order to identify the correct fuel pump for your application, it is necessary to determine the position of the inlet, outlet and separator fitting (where applicable) in relation to the rocker arm. The angle between the rocker arm and the fuel inlet is expressed in terms of clock position. Place pump with rocker arm in the 12 o'clock position. The rocker arm must be held behind the fuel pump body. (The bottom of the fuel pump body must face you.) Observe the relationship of the fuel inlet to the rocker arm. This position is the clock position of the pump. Examples of this in the outline drawing below show that if the fuel inlet is at position "A", it is considered a 6 o'clock pump, if at position "B". a 3 o'clock pump, and at position "C" an 8 o'clock pump.

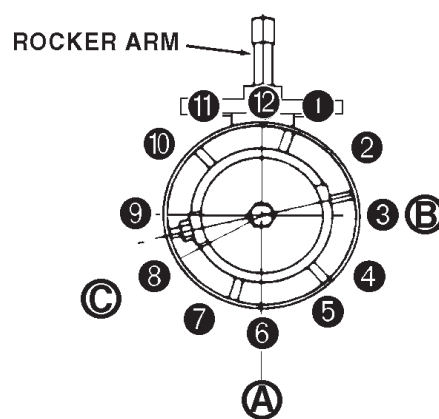

AC STYLE FUEL PUMPS

Engines Manufactured Before February 1, 1979		CLOCK POSITION				
Engine	Application	Flange I.D. #	Inlet	Outlet	Separator	Part #
GM153, 230, 250, 292, (4&6 cyl)	Crusader, Mercruiser, OMC	6790	8	4	—	18-7256
Hercules B, D, J, JXD, Series, M Series	Chris-Craft, US Marine, Owens Yacht	7241	6	9	—	—
GM225, PB-V215 (V-6)	OMC, Palmer	40001	8	4	—	—
GM-V-8, 283, 307, 327, 350, 409	Chris-Craft, Owens, Universal, Crusader	40155	9	3	10	18-7260
GM V-8 307, 350	OMC	40778	4	10	9	—
Chrysler V-8 273, 318, 340, 360	Chrysler	40781	4	8	—	18-7264
Engines Manufactured After January 31, 1979						
Chrysler V-8 318, 360	Chrysler	6766	4	8	4	18-7254
Chrysler V-8 361, 400, 413, 440	Chrysler	6767	4	8	4	18-7255
GM V-8 305, 350, 400	Mercruiser, OMC, Chris-Craft	41412	9	3	9	18-7265
Ford V-8 302, 351w	Ford, Mercruiser, Commander	41413	5	4	4	18-7266
Ford V-8 302, 351w	OMC, Mercruiser, Pleasurecraft, Thermo-Electron	41414	7	5	4	18-7267
GM V-8 305, 307, 350, 400	Harman, OMC, Thermo-Electron (5.25-6.5 PSI)	41415	7	5	8	18-7268*
GM V-8 454	Mercruiser	41416	9	8	7	—
GM V-8 305, 350, 400	Thermo-Electron (5.75-7PSI)	41417	7	5	8	18-7270
GM V-8 454	Thermo-Electron	41418	3	9	8	18-7271
GM V-8 283, 305, 350, 400	Chris-Craft, Crusader, Hardin, Thermo-Electron (5.75-6.5 PSI)	41419	3	9	8	18-7272
GM V-8 305, 350, 400	Mercruiser	41421	10	9	7	18-7274
GM V-8 454	Hawk, Mercruiser	41422	9	3	7	18-7275

*18-7268 – Dual Diaphragm requires sight glass

CARTER STYLE FUEL PUMPS

Engine	Application	Flange I.D. #	Inlet	Outlet	Sight Tube Connection	Part #
GM (4 & 6 cyl) 153,181,250, 225	Chris-Craft, Indmar, Marine Power, Mercruiser, OMC	60032	8	4	3	18-7278
GM V-8 305, 350	Volvo Penta	61125/6973	9	11	9	18-7281
For Inline (4 cyl) 120, 140, 3.0L, 224 CID	Mercruiser	60337	8	3	8	18-7282
GM V-6 262/4.36	OMC	60201	2	4	9	18-7289
GM V-8 305, 350	Mercruiser, Panther	60600	10	9	4	18-7283
GM V-6 231, 262	Hardin, Mercruiser	60315	8	3	8	18-7284
XP Stamped Steel Pump	Volvo Penta AQ120B (spec# 867465), AQ125A/B, AQ131A/B/C/D, AQ140A (spec# 867464), BB140A, AQ145A, BB145A, AQ151A/B/C, AQ171A/C, AQ230A/B, AQ250A/B, AQ251A	60029	3	6	11	18-7286



18-7628
INTAKE MANIFOLD
 Small-block GM with vortec cylinder heads
 Brass-lined water jackets for salt water applications

ALL SIERRA CARBURETORS INCLUDE BASE GASKET

- Precision remanufactured to meet or exceed OEM specifications
- Re-calibrated and re-engineered to maximize fuel efficiency and performance
- All carburetors are flow tested throughout the entire throttle range
- Fuel mixture and idle settings are pre-set to ensure that only minor idle and choke adjustments are necessary during installation
- All bases are resurfaced and throttle shaft bushings replaced

UNIVERSAL CARBURETORS



18-7635
CARBURETOR
(REMANUFACTURED)
 300 CFM Holley 2V
 Use replacement gasket **18-0360**



18-7636
CARBURETOR
(REMANUFACTURED)
 500 CFM Holley 2V
 Use replacement gasket **18-0994**



18-7637
CARBURETOR
(REMANUFACTURED)
 600 CFM Holley 4V (Front inlet)
 Gasket included • Use replacement gasket **18-0647**



18-7638
CARBURETOR
(REMANUFACTURED)
 600 CFM Holley 4V-side inlet



18-7640
CARBURETOR
(REMANUFACTURED)
 Universal Q-jet with electric choke
 Use replacement carb kit **18-7018**
 Use replacement gasket **18-0462**

MERCUISER CARBURETORS

NEW CASTING NON-REMANUFACTURED



18-7370N
CARBURETOR
 Replaces: 3310-860070A2, 3310-806077A2,
 3310-806078A2, 1389-9562A1, 1389-9350A2,
 1389-8490A2, 1389-815396A2, 3310-806077A2
 For: MCM 120/2.5L & 140/3.0L
 Gasket included • Use replacement gasket **18-0994**



18-7373N
MERCARB 2V
CARBURETOR
 Replaces:
 Mercruiser 3310-864941A01
 2002-2004 4.3L engines (s/n OM615000-OW300012
 Use Replacement Carb Kit **18-7098-1**
 Gasket included • Use replacement gasket **18-0994**



18-7375N
CARBURETOR
 Replaces: 3310-864942A01, 3310-861448A1
 For: 1998-2004 MCM 5.0L
 Gasket included • Use replacement gasket **18-0994**



18-7376N
CARBURETOR
 Replaces: 3310-864943A01, 3310-861245A1
 For: 1998 and newer 5.7L applications
 Gasket included • Use replacement gasket **18-0994**



18-7615N
Q-JET CARBURETOR
 Replaces: 1347-816373A4,
 1347-804624R1,
 1347-804624R02
 Use Replacement Carb Kit **18-7095**
 Gasket included • Use replacement gasket **18-2848**

ALL SIERRA CARBURETORS INCLUDE BASE GASKET



18-7603-1
CARBURETOR
(REMANUFACTURED)
 2 Barrel - Rochester
Replaces: Mercruiser 1347-818622, 1376-5659A1, 1347-818622 1, 1347-818622R02
Rochester 7044185
 Use replacement carb kit **18-7075**
 Use replacement gaskets **18-0994 & 18-0434**



18-7604-1
CARBURETOR
(REMANUFACTURED)
 4 Barrel - Rochester
Replaces:
 Mercruiser 3304-9354A2, 1347-804623R02
 Use replacement carb kit **18-7095**
 Use replacement gasket **18-2848**



18-7605-1
CARBURETOR
(REMANUFACTURED)
 4 Barrel - Rochester
Replaces: Mercruiser 1347-9661A3, 1347-804623A1, 1347-804623R02
Rochester 17057283, 17057285, 17059291, 17059292, 17080564, 17080565
 Use replacement carb kit **18-7095**
 Use replacement gasket **18-2848**



18-7607-1
CARBURETOR
(REMANUFACTURED)
Replaces: Rochester 17082403
For: Rochester Carb: Crusader 454
 Use replacement carb kit **18-7095**
 Use replacement gasket **18-2848**



18-7608-1
CARBURETOR
(REMANUFACTURED)
 2 Barrel - Rochester
Replaces: Mercruiser 1347-818620, 1347-818620 1, 1347-818620R02, Rochester 7040080, 7040083, 7040089, 7042183, 7043183, 7043184, 17059057, 17059052
 Use replacement carb kit **18-7070**
 Use replacement gasket **18-0356**



18-7609-1
CARBURETOR
(REMANUFACTURED)
 2 Barrel - Rochester
Replaces: Mercruiser 1347-818619, 1347-818619 1, 1347-818619 1R02, Rochester 7036543, 7040082, 7041369, 7043182, 7044182, 17059054
 Use replacement carb kit **18-7070**
 Use replacement gasket **18-0356**



18-7610-1
CARBURETOR
(REMANUFACTURED)
 2 Barrel - Rochester
Replaces: Mercruiser 1347-818621, 1347-818621 1, 1347-818621 1R02
Rochester 17081060
 Use replacement carb kit **18-7070**
 Use replacement gasket **18-0356**



18-7611-2
CARBURETOR
(REMANUFACTURED)
 2 Barrel - Rochester
Replaces: Mercruiser 3310-807312A1, 3310-807312R02
 Use replacement carb kit **18-7098-1**
 Use replacement gasket **18-0994**



18-7613-1
CARBURETOR
(REMANUFACTURED)
 4 Barrel - Carter (Weber)
Replaces: Mercruiser 3310-806969A1, 3310-806969R01
 Use replacement carb kit **18-7748**
 Use replacement gasket **18-0467**



18-7615-1
CARBURETOR
(REMANUFACTURED)
 4 Barrel - Rochester
Replaces: Mercruiser 1347-816373A4, 1347-804624R1, 1347-804624R02
Rochester 17057298, 17059280, 17059288, 17080561, 17085013
 Use replacement carb kit **18-7095**
 Use replacement gasket **18-2848**



18-7616-1
CARBURETOR
(REMANUFACTURED)
 4 Barrel - Rochester
Replaces: Mercruiser 1347-8288A1, 1347-804626R02
Rochester 1708563, 17057287, 17059287, 17059290, 17080560
 Use replacement carb kit **18-7072**
 Use replacement gasket **18-2848**



18-7639
CARBURETOR
(REMANUFACTURED)
Replaces: 3310-864943A01, 861245A1
 Mercarb-5.7L 2V 1998 and newer 5.7L (OL010337-OW300754) & 5.7L MIE (OL002003-OW090899)
 Use replacement carb kit **18-7098-1**
 Use replacement gasket **18-0994**



18-7617-1
CARBURETOR
(REMANUFACTURED)
 4 Barrel - Rochester
Replaces: Mercruiser 1347-9863A3, 1347-804625R1, 1347-804625R02
Rochester 17059280
 Use replacement carb kit **18-7095**
 Use replacement gasket **18-2848**



18-7618-1
CARBURETOR
(REMANUFACTURED)
 4 Barrel - Rochester
Replaces: Mercruiser 13478289A1, 1347-804624R1, 1347-804624R02
Rochester 17059289, 7044291, 17080561, 17080562
 Use replacement carb kit **18-7095**
 Use replacement gasket **18-2848**



18-7619-1
CARBURETOR
(REMANUFACTURED)
 4 Barrel - Rochester
Replaces: Mercruiser 1347-9142A2, 1347-8460 A3
Rochester 17081299, 17083522, 17059283, 17059298
 Use replacement carb kit **18-7077**
 Use replacement gasket **18-0462**

CARB APPLICATION BEGINS ON NEXT PAGE

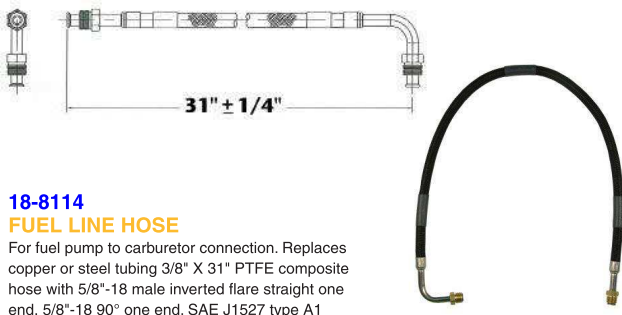

18-8114
FUEL LINE HOSE

For fuel pump to carburetor connection. Replaces copper or steel tubing 3/8" X 31" PTFE composite hose with 5/8"-18 male inverted flare straight one end, 5/8"-18 90° one end. SAE J1527 type A1

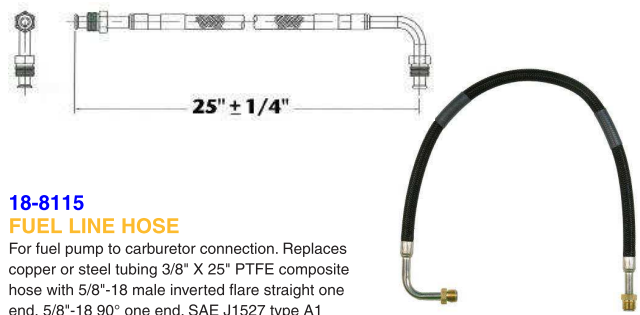

18-8115
FUEL LINE HOSE

For fuel pump to carburetor connection. Replaces copper or steel tubing 3/8" X 25" PTFE composite hose with 5/8"-18 male inverted flare straight one end, 5/8"-18 90° one end. SAE J1527 type A1

MERCURUISER CARBURETORS APPLICATION

Model	Year	# of Cyl.	Beginning Serial #	Ending Serial #	Original Carb #	Replacement Carb #	Mfg. Carb.	Carb Code & Model	Carb #
90	1970-1971	L4	2851424	3225967	1351-4263A1	1347-818619 1	7040082	R2/2GC	18-7609-1
90	1972	L4	3225868	3226957	1351-4263A2	1347-818619 1	7041369	R2/2GC	18-7609-1
110	1963-1966	L4	1357370	2044033	1336-2076	—	7036543	R2/2GC	18-7609-1
120	1972-1973	L4	3377341	3770649	1351-4263A3	1347-818619 1	7041369	R2/2GC	18-7609-1
120	1974-1975	L4	3770650	4469865	1351-5202A1	1347-818619 1	7043182	R2/2GC	18-7609-1
120	1976-1978	L4	4469866	5192048	1351-6065A2	1347-818619 1	7044182	R2/2GC	18-7609-1
120	1979-1982	L4	5192049	6229717	1351-7354A1	1347-818619 1	17059054	R2/2GC	18-7609-1
120/2.5L	1983-1989	L4	6229718	OC853255	1351-8480A2	1348-818621 1	17081060	R2/2GC	18-7610-1
140	1970	L4	2816417	2911439	1351-4032A1	1347-818620 1	7040080	R2/2GC	18-7608-1
140	1970-1973	L4	2911440	3771644	1351-4293A1	1347-818620 1	7040084	R2/2GC	18-7608-1
140	1974-1978	L4	3771645	5157668	1351-5203A1	1347-818620 1	7043184	R2/2GC	18-7608-1
140	1979-1982	L4	5157669	6229717	1351-7355A1	1347-818620 1	17059052	R2/2GC	18-7608-1
140/3.0L	1983-1989	L4	6229718	OC856556	1351-8480A2	1348-818621 1	17081060	R2/2GC	18-7610-1
165 (6 Cyl)	1970-1972	L6	2770032	3354791	1351-4282A1	1347-818620 1	7040083	R2/2GC	18-7608-1
165 (6 Cyl)	1972-1973	L6	3354702	3774864	1351-4871A1	1347-818620 1	7042183	R2/2GC	18-7608-1
165 (6 Cyl)	1974-1978	L6	3774865	5178958	1351-5204A1	1347-818620 1	7043183	R2/2GC	18-7608-1
488	—	—	6170297	1347-8460 6916778	1347-9142A2	—	17059283 17059298 17083522 17081299	R4/4ME	18-7619-1
165 (6 Cyl)	1979-1981	L6	5178959	5813433	1351-7356A1	1347-818620 1	17059050	R2/2GC	18-7608-1
180/1903.7LX	—	—	6916779	Later	1347-8460 1347-9142A2	—	17059283 17059298 17083522 17081299 17083522	R4/4ME R4/4ME	18-7619-1
205/4.3LX	1985-1991	V-6	OA331455	OD714369	3304-9354A2	3304-9354A2	N/A	R4/4MV	18-7604-1
898/200/5.0L	1987-95	V-8	OB525982	OF600999	1389-9670A2	3310-807312A1	N/A	M2/MERCARB	18-7611-2
888	1971-1977	V-8	3108723	4887829	1376-5659A1	1376-818622 1	7044185	R2/2GC	18-7603-1
228	1977-1978	V-8	4765100	5069430	1347-6427A1	1347-9661A3	17057282	R4/4MV	18-7605-1
228 TR & MIE	1977-1978	V-8	4765100	5069430	1347-6438A1	1347-9661A3	17057283	R4/4MV	18-7605-1
228	1978-1981	V-8	5069431	6021783	1347-7361A1	1347-9661A3	17059292	R4/4MV	18-7605-1
228	1982	V-8	6021784	6218461	1347-8296A4	1347-9661A3	17080565	R4/4MV	18-7605-1
223/230/5.0LX	1983-1995	V-8	6218462	OF600999	1347-9661A3	1347-9661A3	17080565	R4/4MV	18-7605-1
228 MIE	1978-1982	V-8	5069431	6040745	1347-7364A1	1347-9661A3	17059291	R4/4MV	18-7605-1
230 MIE	1982-1987	V-8	6040746	OB788151	1347-8290A1	1347-9661A3	17080564	R4/4MV	18-7605-1
255 MIE (GM)	1975-1978	V-8	4175500	4924564	1347-5732A1	1347-8289A1	7044291	R4/4MV	18-7618-1
255 MIE (GM)	1978	V-8	4924565	5195908	1347-7062A1	1347-8289A1	17059289	R4/4MV	18-7618-1
255 MIE (GM)	1979-1980	V-8	5195909	5907057	1347-7365A1	1347-8289A1	17059289	R4/4MV	18-7618-1
260 MIE	1980-1986	V-8	5907058	OB522505	1347-8289A1	1347-8289A1	17080562	R4/4MV	18-7618-1
260/5.7MIE	1987-1993	V-8	OB522506	OF024999	1347-9662A4	1347-816373A4	17080561	R4/4MV	18-7615-1
255	1975-1976	V-8	41745500	4767999	1347-5732A1	1347-8289A1	7044291	R4/4MV	18-7618-1
260	1978	V-8	4908850	5060805	1347-6492A1	1347-816373A4	17057298	R4/4MV	18-7615-1
260	1978-1982	V-8	5060806	6024393	1347-7362A1	1347-816373A4	17059288	R4/4MV	18-7615-1
260	1982-1986	V-8	6024393	OB525981	1347-8292A4	1347-816373A4	17080561	R4/4MV	18-7615-1
260/5.7L ALPHA	1987-1993	V-8	OB525982	OF000454	1347-9662A4	1347-816373A4	17080561	R4/4MV	18-7615-1
5.7L(2BBL)	1996-1997	V-8	OF601000	OK999999	3310-807312A1	3310-807312A1	—	M2/MERCARB	18-7611-1

APPLICATION CONTINUED ON NEXT PAGE

MERCURISER CARBURETORS APPLICATION

Model	Year	# of Cyl.	Beginning Serial #	Ending Serial #	Original Carb #	Replacement Carb #	Mfg. Carb.	Carb Code & Model	Carb #
5.7L (Gen II)	1998-2004	V-8	OL010037	OW300754	3310-864943101	3310-864943101	N/A	M2/MERCARB	18-7639
5.7L BRAVO (w/o High Rise Intake)	1987-1991	V-8	OB525982	OD617327	1347-9662A4	1347-816373A4	17080561	R4/4MV	18-7615-1
5.7L BRAVO (w/ High Rise Intake)	1987-1991	V-8	OB525982	OD617327	1347-8289A1	1347-8289A1	17080562	R4/4MV	18-7618-1
350 MAGNUM ALPHA	1986-1991	V-8	OA635178	OD617327	1347-8289A1	1347-8289A1	17080562	R4/4MV	18-7618-1
5.7L SKI	1985-1993	V-8	OA338533	OF025099	1347-9415T	1347-9415T	17085013	R4/4MV	18-7615-1
5.7L SKI(2BBL)	1996-1997	V-8	OF775200	OK999999	3310-807312A1	3310-807312A1	—	M2/MERCARB	18-7611-2
300MR/TRS	1985-1986	V-8	6668677	OB430367	1347-7498A7	1347-7498A7	17059280	R4/4MV	18-7615-1
330 MCM	1977-1978	V-8	4623115	5027230	1347-6493A1	1347-8291A3	17057287	R4/4MV	18-7616-1
330 MCM	1977-1981	V-8	5027231	6083144	1347-7363A1	1347-8291A3	17059290	R4/4MV	18-7616-1
330 MCM	1982-1987	V-8	6083145	OB816540	1347-8291A3	1347-8291A3	1708563	R4/4MV	18-7616-1
330 MIE	1977-1978	V-8	4623115	5226384	1347-6493A1	1347-8288A1	17057287	R4/4MV	18-7616-1
330 MIE	1979-1980	V-8	5226385	5889913	1347-7366A1	1347-8288A1	17059287	R4/4MV	18-7616-1
340/7.4L MIE	1981-1992	V-8	5889914	OD715493	1347-8288A1	1347-8288A1	17080560	R4/4MV	18-7616-1
7.4L MIE	1995-1997	V-8	OF350000	OK999999	3310-806969A1	3310-806969A1	9780	WEBER	18-7613-1
7.4L BRAVO I/II	1988-1991	V-8	OB771113	OD603117	1347-8291A3	1347-8291A3	17080563	R4/4MV	18-7616-1
7.4L BRAVO I/II	1995-1997	V-8	OF352000	OK999999	3310-806969A1	3310-806969A1	9780	WEBER	18-7613-1
7.4L BRAVO III	1996-1997	V-8	OF800700	OK999999	3310-806969A1	3310-806969A1	9780	WEBER	18-7613-1
370/400	1978-1987	V-8	4179554	OB714586	1347-7498A2	1347-9863A3	17059280	R4/4MV	18-7617-1
454 MAG ALPHA	1986-1988	V-8	OA631894	OB785148	1347-8291A3	1347-8291A3	17080563	R4/4MV	18-7616-1
454 MAG BRAVO	1988-1992	V-8	OB721206	OD808068	1347-7498A2	1347-9863A3	17059280	R4/4MV	18-7617-1



ALL SIERRA CARBURETORS INCLUDE BASE GASKET

NEW CASTING
NON-REMANUFACTURED



18-7615N
Q-JET CARBURETOR
Replaces: 1347-816373A4,
1347-804624R1,
1347-804624R02
Use replacement carb kit **18-7095**

Heat riser choke



18-7608-1
CARBURETOR
(REMANUFACTURED)
2 Barrel Rochester
Replaces: OMC 381668, 980528,
982219, 982217
Use replacement carb kit **18-7070**
Use replacement gasket **18-0356**

Heat riser choke



18-7609-1
CARBURETOR
(REMANUFACTURED)
2 Barrel Rochester
Replaces: OMC 382733, 980530,
982217, 984180, 381494, 772831
Use replacement carb kit **18-7070**
Use replacement gasket **18-0356**



18-7615-1
CARBURETOR
(REMANUFACTURED)
4 Barrel Rochester
Replaces: OMC 981705, 982223, 983855,
981359, 981564, 985822, 981803, 981428
Use replacement carb kit **18-7095**
Use replacement gasket **18-2848**



18-7605-1
CARBURETOR
(REMANUFACTURED)
4 Barrel Rochester
Replaces: OMC 382821, 383766, 384194
Use replacement carb kit **18-7095**
Use replacement gasket **18-2848**



18-7619-1
CARBURETOR
(REMANUFACTURED)
For: V-8, 305 & 350 CID
Models: AQ225B, C, D, E, F, 225 A,B,
BB225 A, AV, B, C, 290 A, AQ260A, B,
260 A, AV, B, C, 501 A/M S4A, 570 M S4A
Use replacement carb kit **18-7095**
Use replacement gasket **18-0462**

OMC STERN DRIVE CARBURETOR APPLICATION

HP	MODEL	YEAR	OMC CARBURETOR #	MFG CARBURETOR #	CARB. CODE & MODEL	PART #
80	80	1968-1969	382733, 772831	7028085, 17059053, 17086064, 17087311	R2, 2GC	18-7609-1
90	90	1970-1971	382733, 772831	7028085, 17059053, 17086064, 17087311	R2, 2GC	18-7609-1
120	120 (400 SERIES)	1972-1986	381668, 980528, 982219	7044186, 17059056	R2, 2GC	18-7608-1
140	140 (400 SERIES)	1973-1985	979821, 980530, 982217, 984180	17086107	R2, 2GC	18-7608-1
155	155	1967-1972	772831	7026180	R2, 2GC	18-7609-1
165	165	1972-1976	979821, 980530	17086107	R2, 2GC	18-7609-1
185	185	1989	984180	17086064	R2, 2GC	18-7609-1
200	200	1966-1968	381494	7025187	R2, 2GC	18-7609-1
210	210	1968-1972	382821, 383866	7028282, 7028280	R4, 4MV	18-7605-1
214	215	1971-1976	382821	7028280	R4, 4MV	18-7605-1
225	225	1971-1976	382821	7028280	R4, 4MV	18-7605-1
230	230	1971-1976	382821	7028280	R4, 4MV	18-7605-1
230	230 (800 SERIES)	1979-1989	981705, 982223	17057290, 17059285, 17059286, 17086117	R4, 4MV	18-7615-1
245	245	1972-1975	384194	7040284	R4, 4MV	18-7605-1
250	250	1970-1974	384194	7040284	R4, 4MV	18-7605-1
260	260 (800 SERIES)	1975-1976	384194	7040284	R4, 4MV	18-7605-1
260	260 (800 SERIES)	1979-1989	982223	17057290, 17059285, 17059286, 17086117	R4, 4MV	18-7615-1
	2.5L	1982-1986	982219, 982217	17059056, 17059053	R2, 2GC	18-7608-1
	3.0L	1982-1986	982219, 982217	17059056, 17059053	R2, 2GC	18-7608-1
	3.0L	1987-1990	984180	17086064	R2, 2GC	18-7608-1
	3.8L (4V)	1979-1985	983855	17082515, 17085010	R4, 4MV	18-7615-1
	4.3L (4V)	1979-1989	983855	17082515, 17085010	R4, 4MV	18-7615-1
	5.0L (GM / 4V)	1979-1989	982223	17057290, 17059285, 17059286, 17086117	R4, 4MV	18-7615-1
	5.7L (4V)	1979-1989	982223	17057290, 17059285, 17059286, 17086117	R4, 4MV	18-7615-1
	305 CID ⊕	1977-1983	981359, 982215,	17057290, 17059285, 17059286, 17086117	R4, 4MV	18-7615-1
	350 CID ⊕	1977-1983	981564, 982223	17057290, 17059285, 17059286, 17086117	R4, 4MV	18-7615-1
	350 (4V)	1988-1989	985822	17057290, 17059285, 17059286, 17086117	R4, 4MV	18-7615-1
	454 CID ⊕	1977-1978	981803, 981428	17057290, 17059285, 17059286, 17086117	R4, 4MV	18-7615-1

⊕ In-Board

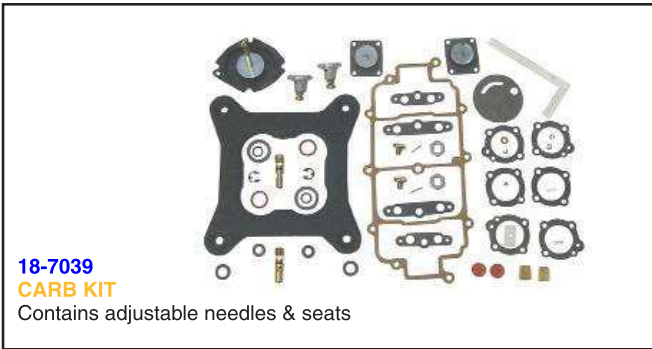

18-7039
CARB KIT
Contains adjustable needles & seats



18-7095
CARB KIT

CARBURETOR TO CARBURETOR KIT INTERCHANGE

Carburetor #	Carb. Kit #	Float #	Carburetor #	Carb. Kit #	Float #	Carburetor #	Carb. Kit #	Float #
INBOARD								
CARTER/WEBER			CARTER/WEBER (CONT.)			FORD (CONT.)		
2617	18-7725	—	6212	18-7089	—	E8JL-9510-DA	18-7017	—
2618	18-7725	—	6310	18-7022	—	E9JL-DA	18-7017	—
2669	18-7025	—	6446	18-7092	—	F1JL-AA	18-7236	—
2853	18-7022	18-7201	9263	18-7091	—	F1JL-EA	18-7727	—
2911	18-7725	—	9264	18-7091	—	F1JL-BA	18-7729	—
2912	18-7725	—	9661	18-7749	—	F1JL-CA	18-7245	—
2935	18-7725	—	9770	18-7749	—	F1JL-EA	18-7727	—
2955	18-7022	—	9781	18-7749	—	HOLLEY		
3035	18-7725	—	9770SA	18-7749	—	R-4397A	18-7096	—
3041	18-7022	18-7201	9781S	18-7749	—	R-4473A	18-7096	18-7206
3116	18-7022	18-7201	9600	18-7748	—	R-4473AAS	18-7096	18-7206
3117	18-7725	—	9662	18-7748	—	R-4607A	18-7096	18-7206
3157	18-7725	—	9663	18-7748	—	R-4608A	18-7096	18-7206
3195	18-7725	—	9665	18-7748	—	R-4608AAS	18-7096	18-7206
3204	18-7022	18-7201	9666	18-7748	—	R-6150A	18-7081	18-7206
3205	18-7025	—	9772	18-7748	—	R-6151A	18-7096	18-7206
3212	18-7726	—	9773	18-7748	—	R-6151AAA	18-7096	18-7206
3213	18-7091	—	9774	18-7748	—	R-6152A	18-7096	18-7206
3214	18-7091	—	9776	18-7748	—	R-6152AAA	18-7096	18-7206
3285	18-7022	18-7201	9776	18-7748	—	R-6317A	18-7081	18-7206
3314	18-7022	18-7201	9777	18-7748	—	R-6317-1A	18-7081	18-7206
3354	18-7022	18-7201	9780	18-7748	—	R-6407A	18-7096	18-7206
3355	18-7725	—	9782	18-7748	—	R-6647A	18-7728	—
3389	18-7725	—	9665S	18-7748	—	R-6647AAA	18-7728	—
3390	18-7725	—	9772SA	18-7748	—	R-6576A	18-7096	18-7206
3392	18-7091	—	9776S	18-7748	—	R-7036A	18-7081	18-7206
3543	18-7091	—	9776SA	18-7748	—	R-7128A	18-7017	—
3660	18-7022	—	9776SB	18-7748	—	R-7159A	18-7017	—
3887	18-7022	18-7201	9779S	18-7748	—	R-7163A	18-7017	—
3951	18-7080	—	9780S	18-7748	—	R-9392A	18-7096	—
3971	18-7080	—	FORD			R-9393A	18-7729	—
3979	18-7726	—	C9FF-9510-D	18-7096	18-7206	R-9394A	18-7729	—
3980	18-7089	—	C9FF-9510-E	18-7096	18-7206	R-50399A	18-7729	—
3981	18-7726	—	D1FF-9510-LA	18-7081	18-7206	R-50399-1A	18-7729	—
4157	18-7022	18-7201	D1FF-9510-MA	18-7096	18-7206	R-50405A	18-7729	—
4207	18-7080	—	D1FF-9510-NA	18-7096	18-7206	R-50405-1A	18-7729	—
4208	18-7080	—	D1JJ-9510-B	18-7081	18-7206	R-50417A	18-7236	—
4268	18-7726	—	D2JL-9510-C	18-7096	18-7206	R-50417-1A	18-7236	—
4394	18-7080	—	D2JL-9510-E	18-7096	18-7206	R-50418A	18-7729	—
4476	18-7091	—	D3JL-9510-S	18-7081	18-7206	R-50419A	18-7729	—
4695	18-7023	—	D4JL-9510-F	18-7017	—	R-50419-1A	18-7237	—
4699	18-7089	—	D4JL-9510-G	18-7017	—	R-50419-2A	18-7237	—
6117	18-7023	—	D4JL-9510-J	18-7017	—	R-50461A	18-7236	—
6130	18-7089	—	E0JL-9510-CA	18-7096	—	R-50461-1A	18-7236	—

CARBURETOR TO CARBURETOR KIT INTERCHANGE (Cont.)

Carburetor #	Carb. Kit #	Float #	Carburetor #	Carb. Kit #	Float #	Carburetor #	Carb. Kit #	Float #
HOLLEY (CONT.)			HOLLY (CONT.)			MERCURY MARINE (CONT.)		
R-50462A	18-7729	—	R-84022AA	18-7040	—	1347-7498A2	18-7095	18-7201
R-50462-1A	18-7729	—	R-84023AA	18-7039	—	1347-7498A7	18-7095	18-7201
R-50463A	18-7237	—	R-84024AA	18-7040	—	1347-8288A1	18-7095	18-7201
R-50463-1A	18-7237	—	R-84026AA	18-7040	—	1347-8289A1	18-7095	18-7201
R-50464A	18-7017	—	R-84026-1AA	18-7040	—	1347-8290A1	18-7095	18-7201
R-50467A	18-7236	—	R-84026-2AA	18-7040	—	1347-8291A3	18-7095	18-7201
R-50467-1A	18-7236	—	R-84028AA	18-7039	—	1347-8292A4	18-7095	18-7201
R-50468A	18-7729	—	R-84037AA	18-7040	—	1347-8296A4	18-7095	18-7201
R-50468-1A	18-7729	—	R-84038AA	18-7039	—	1347-8460A3	18-7077	18-7201
R-50469A	18-7245	—	R-84039AA	18-7039	—	1347-9142A2	18-7095	18-7201
R-50469-1A	18-7245	—	R-84040AA	18-7040	—	1347-9415T	18-7095	18-7201
R-50470A	18-7017	—	R-84041AA	18-7070	—	1347-9661A3	18-7095	18-7201
R-50483A	18-7727	—	R-84042AA	18-7040	—	1347-9662A4	18-7095	18-7201
R-80262A	18-7729	—	R-84044AA	18-7039	—	1347-9863A3	18-7095	18-7201
R-80263A	18-7236	—	R-84044-1AA	18-7039	—	1351-3635A1	18-7070	18-7200
R-80264A	18-7729	—	R-84046A	18-7727	—	1351-4032A1	18-7070	18-7200
R-80265A	18-7237	—	R-84046AA	18-7039	—	1351-4263A1	18-7070	18-7200
R-80311A	18-7241	—	MERCURY MARINE			1351-4263A2	18-7070	18-7200
R-80311-1A	18-7241	—	1336-2076	18-7070	18-7200	1351-4263A3	18-7070	18-7200
R-80311-2A	18-7241	—	1336-3594A1	18-7070	18-7200	1351-4282A1	18-7070	18-7200
R-80312A	18-7238	—	1337-2103	18-7078	—	1351-4293A1	18-7070	18-7200
R-80312-1A	18-7238	—	1337-2604	18-7078	—	1351-4871A1	18-7070	18-7200
R-80313A	18-7246	—	1338-2161	18-7071	—	1351-5202A1	18-7070	18-7200
R-80313-1A	18-7246	—	1338-2166	18-7071	—	1351-5203A1	18-7070	18-7200
R-80315A	18-7237	—	1338-2428	18-7071	—	1351-5204A1	18-7070	18-7200
R-80315-1A	18-7237	—	1338-2431	18-7071	—	1351-6065A2	18-7070	18-7200
R-80316A	18-7246	—	1338-2608	18-7071	—	1351-7354A1	18-7070	18-7200
R-80316-1A	18-7246	—	1338-2609	18-7071	—	1351-7355A1	18-7070	18-7200
R-80318A	18-7017	—	1338-2633	18-7070	18-7200	1351-7356A1	18-7070	18-7200
R-80318-1A	18-7017	—	1338-2991	18-7070	18-7200	1351-8480A2	18-7070	18-7200
R-80319A	18-7245	—	1346-2770	18-7080	—	1356-4066	18-7096	18-7206
R-80319-1A	18-7245	—	1347-3237A2	18-7072	18-7201	1356-4642	18-7081	18-7206
R-80320A	18-7236	—	1347-3237A3	18-7072	18-7201	1356-5155	18-7096	18-7206
R-80320-1A	18-7236	—	1347-3237A4	18-7072	18-7201	1356-5169	18-7096	18-7206
R-80321A	18-7246	—	1347-3342	18-7072	18-7201	1376-5659A1	18-7075	18-7202
R-80321-1A	18-7246	—	1347-3353	18-7072	18-7201	1376-5659A2	18-7075	18-7202
R-80328A	18-7239	—	1347-3689A1	18-7072	18-7201	1376-5744A1	18-7075	18-7202
R-80328-1A	18-7239	—	1347-4179A1	18-7072	18-7201	1376-5990A1	18-7076	18-7202
R-80328-2A	18-7239	—	1347-4179A2	18-7072	18-7201	1376-6152A1	18-7075	18-7202
R-80330A	18-7241	—	1347-4180A1	18-7072	18-7201	1376-6491A1	—	18-7202
R-80330-1A	18-7241	—	1347-4533A1	18-7072	18-7201	1376-8295A3	—	18-7202
R-80378A	18-7242	—	1347-5326A2	18-7072	18-7201	1389-815396A2	18-7098-1	18-7202
R-80378-1A	18-7242	—	1347-5732A1	18-7072	18-7201	1389-815397A2	18-7098-1	18-7202
R-80382A	18-7244	—	1347-5981A1	18-7072	18-7201	1389-8488A2	18-7097	18-7202
R-80382-1A	18-7244	—	1347-6427A1	18-7072	18-7201	1389-8489A5	18-7097	18-7202
R-80383A	18-7245	—	1347-6438A1	18-7072	18-7201	1389-8490A2	18-7097	18-7202
R-80383-1A	18-7245	—	1347-6492A1	18-7072	18-7201	1389-9562A1	18-7098-1	18-7202
R-80385A	18-7246	—	1347-6493A1	18-7072	18-7201	1389-9563A1	18-7098-1	18-7202
R-80386A	18-7244	—	1347-7062A1	18-7072	18-7201	1389-9564A1	18-7098-1	18-7202
R-80386-1A	18-7244	—	1347-7361A1	18-7095	18-7201	1389-9670A2	18-7098-1	18-7202
R-80390A	18-7243	—	1347-7362A1	18-7095	18-7201	3300-8886A2	18-7095	18-7201
R-80364	18-7729	—	1347-7363A1	18-7095	18-7201	3304-9353A2	18-7097	18-7202
R-80434	18-7730	—	1347-7364A1	18-7095	18-7201	3304-9354A2	18-7095	18-7201
R-80444A	18-7241	—	1347-7365A1	18-7095	18-7201	3304-9565A1	18-7098-1	18-7202
R-84018AA	18-7039	—	1347-7366A1	18-7095	18-7201			

CARBURETOR TO CARBURETOR KIT INTERCHANGE (Cont.)

Carburetor #	Carb. Kit #	Float #	Carburetor #	Carb. Kit #	Float #	Carburetor #	Carb. Kit #	Float #
ROCHESTER			ROCHESTER (CONT.)			ROCHESTER (CONT.)		
17056287	18-7072	18-7201	17083110	18-7086	18-7200	7025082	18-7070	18-7200
17057130	18-7086	18-7202	17083515	18-7095	18-7201	7025180	18-7078	—
17057131	18-7086	18-7202	17083522	18-7095	18-7201	7025183	18-7071	—
17057132	18-7076	18-7202	17084001	18-7095	18-7201	7025184	18-7071	—
17057133	18-7086	18-7202	17084516	18-7095	18-7201	7025188	18-7070	18-7200
17057134	18-7086	18-7202	17085008	18-7086	18-7200	7025564	18-7078	—
17057138	18-7086	18-7202	17085010	18-7072	18-7201	7025638	18-7071	—
17057139	—	18-7202	17085013	18-7095	18-7201	7025662	18-7071	—
17057282	18-7072	18-7201	17086064	18-7070	18-7200	7025756	18-7078	—
17057283	18-7072	18-7201	17086069	18-7095	18-7201	7026084	18-7070	—
17057287	18-7072	18-7201	17086107	18-7086	18-7200	7026088	18-7070	18-7200
17057290	18-7095	18-7201	17086115	18-7095	18-7201	7027080	18-7072	18-7201
17057292	18-7072	18-7201	17086116	18-7095	18-7201	7027081	18-7072	18-7201
17057295	18-7072	18-7201	17086117	18-7095	18-7201	7027083	18-7072	18-7201
17057298	18-7072	18-7201	17087311	18-7070	18-7200	7027088	18-7072	18-7201
17057299	18-7072	18-7201	17087311	18-7095	18-7201	7028085	18-7070	18-7200
17058280	18-7072	18-7201	7013071	18-7019	—	7028086	18-7070	18-7200
17059050	18-7070	18-7200	7015087	—	18-7200	7028188	18-7070	18-7200
17059051	18-7086	18-7200	7015088	—	18-7200	7028280	18-7072	18-7201
17059052	18-7070	18-7200	7015089	—	18-7200	7028282	18-7072	18-7201
17059053	18-7070	18-7200	7015090	18-7019	—	7029280	18-7072	18-7201
17059054	18-7070	18-7200	7015091	18-7019	—	7029285	18-7072	18-7201
17059055	—	18-7200	7015097	—	18-7200	7036543	18-7070	18-7200
17059056	—	18-7200	7015098	—	18-7200	7036646	18-7070	18-7200
17059057	18-7086	18-7200	7019082	18-7070	18-7200	7037082	18-7072	18-7201
17059058	18-7086	18-7200	7019084	18-7019	—	7040080	18-7070	18-7200
17059059	18-7086	18-7202	7020082	—	18-7200	7040081	18-7070	18-7200
17059060	18-7086	18-7200	7020084	18-7019	—	7040082	18-7070	18-7202
17059280	18-7095	18-7201	7020085	18-7019	—	7040083	18-7070	18-7200
17059283	18-7095	18-7201	7020087	18-7078	—	7040084	18-7070	18-7200
17059285	18-7095	18-7201	7020088	18-7070	18-7200	7040283	18-7072	18-7201
17059286	18-7095	18-7201	7020991	18-7078	—	7040284	18-7072	18-7201
17059287	18-7095	18-7201	7020992	18-7070	18-7200	7041187	—	18-7200
17059288	18-7095	18-7201	7020993	18-7070	18-7200	7041280	18-7072	18-7201
17059289	18-7095	18-7201	7020994	18-7071	—	7041285	18-7072	18-7201
17059290	18-7095	18-7201	7020995	18-7078	—	7041369	18-7070	18-7200
17059291	18-7095	18-7201	7020996	18-7071	—	7041831	18-7072	18-7201
17059292	18-7095	18-7201	7023080	—	18-7200	7042181	—	18-7200
17059293	18-7095	18-7201	7023084	18-7078	—	7042183	18-7070	18-7200
17059294	18-7095	18-7201	7023085	18-7078	—	7043182	18-7070	18-7200
17059295	18-7095	18-7201	7023088	18-7078	—	7043183	18-7070	18-7200
17059296	18-7095	18-7201	7023089	18-7078	—	7043184	18-7070	18-7200
17059298	18-7095	18-7201	7023181	18-7078	—	7043259	—	18-7201
17065977	18-7072	18-7201	7023183	18-7078	—	7043282	—	18-7201
17080050	18-7086	18-7200	7023186	—	18-7200	7044182	18-7070	18-7200
17080350	—	18-7202	7023188	—	18-7200	7044185	18-7075	18-7202
17080560	18-7095	18-7201	7024083	18-7071	—	7044186	—	18-7200
17080561	18-7095	18-7201	7024084	18-7078	—	7044187	18-7075	18-7202
17080562	18-7095	18-7201	7024086	18-7078	—	7044283	18-7072	18-7201
17080563	18-7095	18-7201	7024087	18-7071	—	7044284	18-7072	18-7201
17080564	18-7095	18-7201	7024089	18-7071	—	7044286	18-7072	18-7201
17080565	18-7095	18-7201	7024180	18-7071	—	7044287	18-7072	18-7201
17081060	18-7070	18-7200	7024181	18-7071	—	7044288	18-7072	18-7201
17081299	18-7077	18-7201	7024182	18-7078	—	7044289	18-7072	18-7201
17082403	18-7095	18-7201	7024188	—	18-7200	7044290	18-7072	18-7201

CARBURETOR TO CARBURETOR KIT INTERCHANGE (Cont.)

Carburetor #	Carb. Kit #	Float #	Carburetor #	Carb. Kit #	Needle & Seat #	Carburetor #	Carb. Kit #	Needle & Seat #
ROCHESTER (CONT.)			TILLOTSON (CONT.)			TILLOTSON (CONT.)		
7044291	18-7072	18-7201	AJ-56A	18-7013	18-7057	KA-24A	18-7013	18-7057
7045197	18-7076	18-7202	AJ-56AB	18-7013	18-7057	KA-24AT	18-7013	18-7057
7045282	—	18-7201	AJ-57A	18-7013	18-7057	KA-25A	18-7013	18-7057
7045283	18-7072	18-7201	CO-10A	18-7037	18-7057	KA-26A	18-7013	18-7057
SOLEX			CO-10B	18-7037	18-7057	KA-26B	18-7013	18-7057
44PA1	18-7000	—	CO-11A	18-7037	18-7057	KA-27A	18-7013	18-7057
44PHN-3	18-7001	—	CO-1A	18-7037	18-7057	KA-2A	18-7013	18-7057
VOLVO-PENTA			CO-2A	18-7037	18-7057	KA-2AT	18-7013	18-7057
826359-2	18-7095	18-7201	CO-3A	18-7037	18-7057	KA-5A	18-7013	18-7057
826414-5	18-7086	18-7202	CO-4A	18-7037	18-7057	KA-5A	18-7013	18-7057
826415-2	18-7095	18-7201	CO-4B	18-7037	18-7057	KA-7A	18-7013	18-7057
826442-6	18-7095	18-7201	CO-4C	18-7037	18-7057	KA-7B	18-7013	18-7057
835556-2	18-7095	18-7201	CO-4D	18-7037	18-7057	KA-8A	18-7013	18-7057
841667-9	18-7086	18-7202	CO-5A	18-7037	18-7057	KA-8AT	18-7013	18-7057
856138-3	18-7072	18-7201	CO-6A	18-7037	18-7057	KA-9A	18-7013	18-7057
856236-5	18-7040	—	CO-6B	18-7037	18-7057	KA-9AT	18-7013	18-7057
841047-4	18-7095	18-7201	CO-6C	18-7037	18-7057	KB-10A	18-7013	18-7057
841048-2	18-7086	18-7202	CO-7A	18-7037	18-7057	KB-11A	18-7013	18-7057
841313-0	18-7095	18-7202	CO-7B	18-7037	18-7057	KB-12A	18-7013	18-7057
M875398-0	18-7085	—	CO-7C	18-7037	18-7057	KB-14A	18-7013	18-7057
ZENITH			CO-8A	18-7037	18-7057	KB-3A	18-7013	18-7057
34VN	18-7008	—	CO-9A	18-7037	18-7057	KB-3AT	18-7013	18-7057
8963, A-J	18-7732	—	KA-10A	18-7013	18-7057	KB-4A	18-7013	18-7057
8983, A-H	18-7732	—	KA-10AT	18-7013	18-7057	KB-5A	18-7013	18-7057
12091, A	18-7732	—	KA-11A	18-7013	18-7057	KB-6A	18-7013	18-7057
12206	18-7732	—	KA-11AT	18-7013	18-7057	KB-6B	18-7013	18-7057
ZENITH-STROMBERG			KA-12A	18-7013	18-7057	KB-7A	18-7013	18-7057
C1865F	18-7085	—	KA-12AT	18-7013	18-7057	KB-7B	18-7013	18-7057
C1865R	18-7085	—	KA-13A	18-7013	18-7057	KB-8A	18-7013	18-7057
C3040F	18-7085	—	KA-13AT	18-7013	18-7057	KB-9A	18-7013	18-7057
C3040R	18-7085	—	KA-14A	18-7013	18-7057	KC-10A	18-7013	18-7057
C3098F	18-7085	—	KA-14AT	18-7013	18-7057	KC-10AT	18-7013	18-7057
C3098R	18-7085	—	KA-15A	18-7013	18-7057	KC-11A	18-7013	18-7057
C3200F	18-7085	—	KA-16A	18-7013	18-7057	KC-11AT	18-7013	18-7057
C3200R	18-7085	—	KA-16AT	18-7013	18-7057	KC-13A	18-7013	18-7057
C3201F	18-7085	—	KA-17A	18-7013	18-7057	KC-14A	18-7013	18-7057
C3201M	18-7085	—	KA-17AT	18-7013	18-7057	KC-14AT	18-7013	18-7057
C3201R	18-7085	—	KA-18A	18-7013	18-7057	KC-15A	18-7013	18-7057
C3231F	18-7085	—	KA-18AT	18-7013	18-7057	KC-15AT	18-7013	18-7057
C3231R	18-7085	—	KA-19A	18-7013	18-7057	KC-1A	18-7013	18-7057
C3232F	18-7085	—	KA-19AT	18-7013	18-7057	KC-1AT	18-7013	18-7057
C3232M	18-7085	—	KA-20A	18-7013	18-7057	KC-2A	18-7013	18-7057
C3232R	18-7085	—	KA-21A	18-7013	18-7057	KC-2AT	18-7013	18-7057
OUTBOARD TILLOTSON			KA-21AT	18-7013	18-7057	KC-3A	18-7013	18-7057
			KA-21B	18-7013	18-7057	KC-3AT	18-7013	18-7057
Carb #	Carb Kit #	Needle & Seat #	KA-21BT	18-7013	18-7057	KC-4A	18-7013	18-7057
AJ-50A	18-7013	18-7057	KA-21C	18-7013	18-7057	KC-5A	18-7013	18-7057
AJ-52A	18-7013	18-7057	KA-21CT	18-7013	18-7057	KC-5AT	18-7013	18-7057
AJ-53A	18-7013	18-7057	KA-21D	18-7013	18-7057	KC-5B	18-7013	18-7057
AJ-53AT	18-7013	18-7057	KA-21DT	18-7013	18-7057	KC-5BT	18-7013	18-7057
AJ-54A	18-7013	18-7057	KA-22A	18-7013	18-7057	KC-5BTA	18-7013	18-7057
AJ-54AT	18-7013	18-7057	KA-22B	18-7013	18-7057	KC-5C	18-7013	18-7057
AJ-55AO	18-7013	18-7057	KA-22C	18-7013	18-7057	KC-5CT	18-7013	18-7057
AJ-55AT	18-7013	18-7057	KA-23A	18-7013	18-7057	KC-5CTA	18-7013	18-7057

CARBURETOR TO CARBURETOR KIT INTERCHANGE (Cont.)

Carburetor #	Carb. Kit #	Needle & Seat #	Carburetor #	Carb. Kit #	Needle & Seat #	Carburetor #	Carb. Kit #	Needle & Seat #
TILLOTSON (CONT.)			TILLOTSON (CONT.)			WALBRO (CONT.)		
KC-6A	18-7013	18-7057	WB-19D	18-7037	18-7057	WMK-9	18-7021	18-7061
KC-6AT	18-7013	18-7057	WB-1A	18-7037	18-7057	WMK-10	18-7021	18-7061
KC-7A	18-7013	18-7057	WB-1B	18-7037	18-7057	WMK-11	18-7021	18-7061
KC-7AT	18-7013	18-7057	WB-1C	18-7037	18-7057	WMK-12	18-7021	18-7061
KC-7B	18-7013	18-7057	WB-20A	18-7037	18-7057	WMK-13	18-7021	18-7061
KC-7BT	18-7013	18-7057	WB-20B	18-7037	18-7057	WMK-14	18-7021	18-7061
KC-8A	18-7013	18-7057	WB-21A	18-7037	18-7057	WMK-15	18-7021	18-7061
KC-9A	18-7013	18-7057	WB-21B	18-7037	18-7057	WMK-18	18-7021	18-7061
KC-9B	18-7013	18-7057	WB-21C	18-7037	18-7057	WMK-19	18-7021	18-7061
KC-9C	18-7013	18-7057	WB-22A	18-7037	18-7057	WMK-20	18-7021	18-7061
KD-1A	18-7013	18-7057	WB-23A	18-7037	18-7057	WMK-21	18-7021	18-7061
KD-1B	18-7013	18-7057	WB-24A	18-7037	18-7057	WMK-22	18-7021	18-7061
KD-1BR	18-7013	18-7057	WB-25A	18-7037	18-7057	WMK-24	18-7021	18-7061
KD-2A	18-7013	18-7057	WB-26A	18-7037	18-7057	WMK-25	18-7021	18-7061
KD-4A	18-7013	18-7057	WB-26B	18-7037	18-7057	WMK-26	18-7021	18-7061
KD-5A	18-7013	18-7057	WB-27A	18-7037	18-7057	WMK-27	18-7021	18-7061
KD-6A	18-7013	18-7057	WB-27B	18-7037	18-7057	WMK-28	18-7021	18-7061
KD-6AT	18-7013	18-7057	WB-28A	18-7037	18-7057	WMK-29	18-7021	18-7061
KD-6B	18-7013	18-7057	WB-2A	18-7037	18-7057	WMK-30	18-7021	18-7061
KD-6BT	18-7013	18-7057	WB-2B	18-7037	18-7057	WMK-31	18-7021	18-7061
KD-7A	18-7013	18-7057	WB-2C	18-7037	18-7057	WMK-32	18-7021	18-7061
KD-7B	18-7013	18-7057	WB-30A	18-7037	18-7057	WMK-35	18-7021	18-7061
RD-10A	18-7037	18-7057	WB-31A	18-7037	18-7057	WMK-36	18-7021	18-7061
TC-1A	18-7037	18-7057	WB-3A	18-7037	18-7057	WMK-38	18-7021	18-7061
TC-1B	18-7037	18-7057	WB-3B	18-7037	18-7057	WMK-39	18-7021	18-7061
WB-10A	18-7037	18-7057	WB-3C	18-7037	18-7057	WMK-40	18-7021	18-7061
WB-10B	18-7037	18-7057	WB-4A	18-7037	18-7057	WMK-41	18-7021	18-7061
WB-10C	18-7037	18-7057	WB-4B	18-7037	18-7057	WMK-41-1A	18-7021	18-7061
WB-10D	18-7037	18-7057	WB-4C	18-7037	18-7057	WMK-41-1B	18-7021	18-7061
WB-10E	18-7037	18-7057	WB-5A	18-7037	18-7057	WMK-41-3A	18-7021	18-7061
WB-11A	18-7037	18-7057	WB-5B	18-7037	18-7057	WMK-41-3B	18-7021	18-7061
WB-11B	18-7037	18-7057	WB-6A	18-7037	18-7057	WO-8A-1	—	18-7061
WB-12A	18-7037	18-7057	WB-7A	18-7037	18-7057	WO-8A-2	—	18-7061
WB-12B	18-7037	18-7057	WB-7B	18-7037	18-7057	WO-8A-3	—	18-7061
WB-13A	18-7037	18-7057	WB-8A	18-7037	18-7057	WO-8A-4	—	18-7061
WB-13B	18-7037	18-7057	WB-8B	18-7037	18-7057	WO-8A-5	—	18-7061
WB-13C	18-7037	18-7057	WB-8C	18-7037	18-7057	WO-8A-6	—	18-7061
WB-13D	18-7037	18-7057	WB-8D	18-7037	18-7057	WO-9-1	—	18-7061
WB-14A	18-7037	18-7057	WB-9A	18-7037	18-7057	WO-9-2	—	18-7061
WB-14B	18-7037	18-7057	WB-9B	18-7037	18-7057	WO-9-3	—	18-7061
WB-15A	18-7037	18-7057	WB-9C	18-7037	18-7057	WO-9-4	—	18-7061
WB-15B	18-7037	18-7057	WB-9D	18-7037	18-7057	WO-9-5	—	18-7061
WB-15C	18-7037	18-7057	WM-16	18-7021	18-7061	WO-9-6	—	18-7061
WB-15D	18-7037	18-7057	WM-17	18-7021	18-7061	WO-9A-1	—	18-7061
WB-16A	18-7037	18-7057	WALBRO			WO-9A-2	—	18-7061
WB-16B	18-7037	18-7057	WM-23	18-7021	18-7061	WO-9A-3	—	18-7061
WB-16C	18-7037	18-7057	WMD-1	18-7021	18-7061	WO-9A-4	—	18-7061
WB-16D	18-7037	18-7057	WMK-1	18-7021	18-7061	WO-9A-5	—	18-7061
WB-17A	18-7037	18-7057	WMK-2	18-7021	18-7061	WO-9A-6	—	18-7061
WB-17B	18-7037	18-7057	WMK-3	18-7021	18-7061			
WB-17C	18-7037	18-7057	WMK-4	18-7021	18-7061			
WB-19A	18-7037	18-7057	WMK-5	18-7021	18-7061			
WB-19B	18-7037	18-7057	WMK-7	18-7021	18-7061			
WB-19C	18-7037	18-7057	WMK-8	18-7021	18-7061			

FLAMETHROWER ELECTRONIC DISTRIBUTORS

Magnetic triggered billet distributors designed to meet or exceed SAE J1171 Standards.

Performance Features:

- Cobalt magnets and Hall Effect trigger for stable timing and precise spark distribution.
- Compensates for inherent electronic delay
- Synchronized peak current and spark timing reduces heat build-up
- Compatible with most capacitive discharge ignition boxes
- Integrated patented Ignitor II technology with adaptive dwell control
- Non-vented distributor cap equipped with stainless steel fasteners
- Triple screen spark arrestor for added protection



Part No.	Description
18-5481	Ford 351W (Conventional Rotation)
18-5482	Ford 351C, 351M, 400, 429, 460 (Conventional Rotation)
18-5483	Small and BB Chevrolet (Standard Deck height) (Conventional Rotation)
18-5477	Ford 302 (Conventional Rotation)
18-5478	Chrysler LA series (Conventional Rotation)
18-5479	Small and BB Chevrolet (Standard Deck height) Reverse Rotation

THUNDERBOLT HEI DISTRIBUTORS

Designed as a direct replacement for Mercury Thunderbolt IV Ignition Distributors. Meets or Exceeds SAE J1171 Standards.

Performance Features:

- Battery Powered (HEI) High Energy Ignition.
- Uses a Hall-Effect type sensor to trigger ignition accurately even at extremely low RPM.



Part No.	Description
18-5470	GM V8
18-5471	GM V6



DELCO HVS DISTRIBUTORS

Aluminum housing construction replaces weaker Factory plastic housing. Designed as a direct replacement for late model GM HVS Distributor. Meets or Exceeds SAE J1171 Standards.

Performance Features:

- Includes steel gear, which is compatible with flat tappet or hydraulic roller cams.
- Reliable high signal strength trigger system.
- Ball bearing and bushing combination provide maximum timing stability and long life.

Part No.	Description
18-5350	GM Vortec V6
18-5351	GM Vortec V8



DELCO EST DISTRIBUTORS



Aluminum housing construction. Designed as a direct replacement for late model GM EST Distributor. Meets or Exceeds SAE J1171 Standards.

Performance Features:

- Includes steel gear, which is compatible with flat tappet or hydraulic roller cams.
- Reliable high signal strength trigger system.
- Ball bearing and bushing combination provide maximum timing stability and long life.

Part No.	Description
18-5475	GM 4 Cyl
18-5476	GM V6
18-5484-1	GM V8



CONVERSION KITS FOR DELCO EST DISTRIBUTORS



18-5512 I/VL 4 DELCO EST CONVERSION KIT

Description: Converts 4 Cylinder GM Engines to Electronic
Includes: Distributor, Coil, Ignition Wires, and Harnesses



18-5513 V-6 DELCO EST CONVERSION KIT

Description: Converts 6 Cylinder GM Engines to Electronic
Includes: Distributor, Coil, Ignition Wires, and Harnesses



18-5514 V-8 DELCO EST CONVERSION KIT

Description: Converts 8 Cylinder GM Engines to Electronic
Includes: Distributor, Coil, Ignition Wires, and Harnesses

YLM STYLE MAGNETIC BREAKERLESS ELECTRONIC DISTRIBUTOR

Designed for 12 Volt Negative ground systems, the Sierra YLM Series Marine distributors replace original equipment marine distributors with modern, high performance technology. This complete, self-contained ignition system combines the triggering device and amplifier into a single unit that sits inside the distributor housing. A self-contained module/pickup assembly has no moving parts to wear out. Sierra's time tested reliability you need in extreme marine conditions. A simple wiring hook up allows this system to fit a wide variety of marine applications. This ignition system drives both original equipment and high performance coils.

Performance Features:

- Improved performance and combustion efficiency.
- Improved spark plug life.
- Accurate spark timing.
- Reduced maintenance.
- Easy installation.

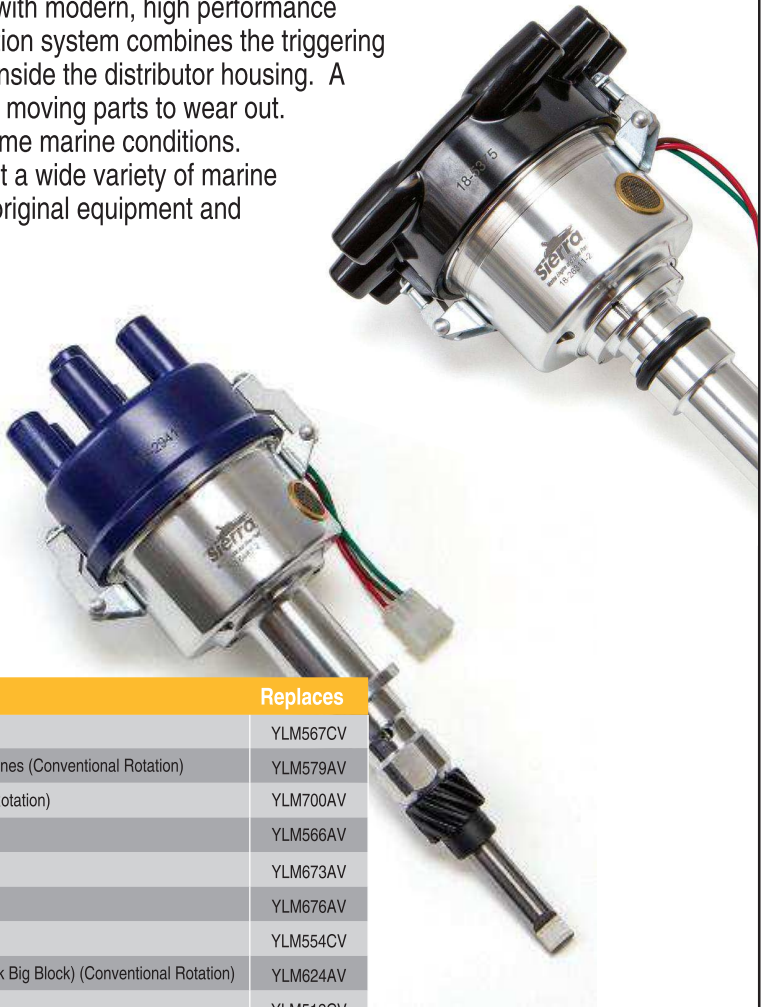

Part No.	Description	Replaces
18-5496-2	Ford 351C, 460 CID (Conventional Rotation)	YLM567CV
18-5497-2	Chrysler V8 273, 318 (67 & UP) 340, 360 CID "LA" Engines (Conventional Rotation)	YLM579AV
18-26310-2	GM 4.3L/262 CID Engines (EVEN Fire) (Conventional Rotation)	YLM700AV
18-26311-2	GM 327Q, 350Q Engines (Conventional Rotation)	YLM566AV
18-5486-2	GM L4, 153 & 181 CID (Conventional Rotation)	YLM673AV
18-5487-2	GM L6, 194, 230, 250, 292 CID (Conventional Rotation)	YLM676AV
18-5489-2	Ford 351W (Conventional Rotation)	YLM554CV
18-5494-2	GM V8 482, 502, 540 CID (Except 348, 409, & Tall Deck Big Block) (Conventional Rotation)	YLM624AV
18-5495-2	Ford 302 (Conventional Rotation)	YLM512CV
18-5498-2	GM V8, 482, 502, 540 CID (Except 348, 409 & Tall Deck Big Block) (Reverse Rotation)	YLM624BV

CONVERSION KITS FOR DELCO EST DISTRIBUTORS



18-5518
I/L 4 SIERRA ELECTRONIC DISTRIBUTOR CONVERSION KIT
 Description: Converts 4 Cylinder GM Engines to Electronic
 Includes: Distributor, Coil, Ignition Wires, and Harnesses



18-5519
I/L 6 SIERRA ELECTRONIC DISTRIBUTOR CONVERSION KIT
 Description: Converts 6 Cylinder GM Engines to Electronic
 Includes: Distributor, Coil, Ignition Wires, and Harnesses



18-5520
V-8 SIERRA ELECTRONIC DISTRIBUTOR CONVERSION KIT
 Description: Converts 8 Cylinder GM Engines to Electronic
 Includes: Distributor, Coil, Ignition Wires, and Harnesses

YL STYLE POINT-TYPE DISTRIBUTORS

Using new materials and technology, the Sierra YL Series Distributor delivers more performance and reliability for today's marine performance engines. This proven ignition system drives both original equipment and high performance coils.

Performance Features:

- Stabilized points eliminate point float and bounce.
- High dielectric condenser with brass case eliminates corrosion.
- Mylar insulation provides greater protection against current leaks and shorting.
- Super Duty cap and rotor.
- Self-Lubricating bushings.



Part No.	Description	Replaces
18-5309-1	Ford 302 (Conventional Rotation)	YL512CV
18-5312-1	Ford 351 (Conventional Rotation)	YL554CV
18-5313-1	Most GM V8 (Conventional Rotation)	YL624AV
18-5315-1	Most GM 4 Cylinder Engines (120 & 140HP) (Conventional Rotation)	YL673AV
18-5316-1	Most GM V8 (Reverse Rotation)	YL624BV
18-5339-1	GM V8 327	YL566AV
18-26104-1	Ford V8 351C (Conventional Rotation)	YL567EV
18-26107-1	4.3L/262 CID Engines (EVEN Fire) (Conventional Rotation)	YL700AV
18-26110-1	Chrysler V8, 273, 318 (1967 & Up), 340 and 360 "LA" Engines	YL579AV
18-26111-1	3.7L Mercruiser (Conventional Rotation)	YL648AV
18-26112-1	GM L6, 194, 230, 250, 292 CID (Conventional Rotation)	YLM676AV

DISTRIBUTOR PARTS



18-5515
DELCO EST DISTRIBUTOR COIL TO MODULE HARNESS
 Fits: Engines equipped with a Delco EST Distributor



18-5516
DELCO EST DISTRIBUTOR TIMING TOOL
 For: Engines equipped with Delco EST and cannot be placed in base timing mode with a diagnostic tool.



18-5517
DELCO EST SHIFT INTERRUPT HARNESS
 For: Engines equipped with a Delco EST Distributor and requires a shift interrupt lead.



18-26800
MARINE CAP CLIP KIT
 Replaces: Mallory 670
 Fits: Mallory Tall Cap



18-26810
PIGTAIL, GM HEI 4 TERMINAL
 Fits: Delco EST Distributors



18-26811
PIGTAIL, GM HEI 2 TERMINAL
 Fits: Delco EST Distributors



18-26812
CONNECTOR, HEI COIL GRAY
 Fits: Delco EST Ignition Coil



18-26813
CONNECTOR, HEI COIL BLACK
 Fits: Delco EST Ignition Coil

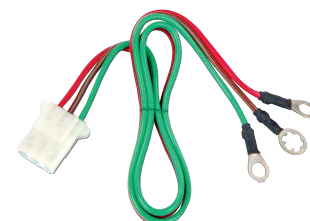

18-26815
DISTRIBUTOR HARNESS
 Replaces: Mallory 29349
 Fits: YLM & YLU Distributors

DISTRIBUTOR PARTS (cont.)



18-61051
SCREW KIT (4 PER PKG)
 Fits: Mercruiser V6 & V8 Thunderbolt
 Distributor Caps



18-26820
DISTRIBUTOR GEAR
 Fits: Standard rotation GM SB & BB engines



18-26821
DISTRIBUTOR CHEV REV GEAR
 Fits: Mallory Distributors in Chevrolet BB & SB reverse rotation engines

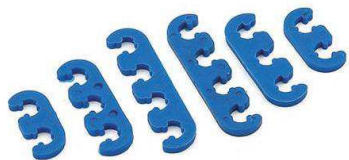

18-28150
WIRE SEPARATOR / BLUE



18-28151
WIRE SEPARATOR / BLACK



18-28175
WIRE MARKERS

ELECTRONIC CONVERSION KIT APPLICATION

CHEVROLET MARINE

Model	Cylinders	Years	Footnotes	Distributor Make	Distributor #	Ignitor Kit	Ignitor II Kit
All Models	V6	1980-1988	Ⓔ	Prestolite	IBM-7021	18-5293-1	18-5287-1
All Models	V8	1976-1988	Ⓔ, Ⓕ	Prestolite	IBM-7011	18-5298	18-5288
All Models	V8	1976-1988	Ⓔ, Ⓖ	Prestolite	IBM-7013	18-5299	18-5289

CHRIS-CRAFT

Model	Cylinders	Years	Footnotes	Distributor Make	Distributor #	Ignitor Kit	Ignitor II Kit
All Models	V8	1963-1971	Ⓔ, Ⓕ	Prestolite	IBM-4115	18-5298	18-5288
All Models	V8	1963-1971	Ⓔ, Ⓖ	Prestolite	IBM-4116	18-5298	18-5288
All Models	V8	1981-1985	Ⓔ, Ⓖ	Prestolite	-	18-5299	18-5289
FL153	I4	1975-1980	Ⓔ, Ⓖ	Delco	-	18-5297	18-5285
FL181	I4	1975-1980	Ⓔ, Ⓖ	Delco	-	18-5297	18-5285

CHRYSLER INBOARD

Model	Cylinders	Years	Footnotes	Distributor Make	Distributor #	Ignitor Kit	Ignitor II Kit
273	V8	1983-1988	Ⓔ, Ⓖ	Prestolite	IBM-7016	18-5299	18-5289
273	V8	1983-1988	Ⓔ, Ⓖ	Prestolite	IBM-7017	18-5299	18-5289
318	V8	1983-1988	Ⓔ, Ⓖ	Prestolite	IBM-7016	18-5299	18-5289
318	V8	1983-1988	Ⓔ, Ⓖ	Prestolite	IBM-7017	18-5299	18-5289
340	V8	1983-1988	Ⓔ, Ⓖ	Prestolite	IBM-7016	18-5299	18-5289
340	V8	1983-1988	Ⓔ, Ⓖ	Prestolite	IBM-7017	18-5299	18-5289
440	V8	1983-1988	Ⓔ, Ⓖ	Prestolite	IBM-7016	18-5299	18-5289
440	V8	1983-1988	Ⓔ, Ⓖ	Prestolite	IBM-7017	18-5299	18-5289
M318A	V8	1959-1972	Ⓔ, Ⓖ	Prestolite	IBM-4106	18-5298	18-5288
M318B	V8	1959-1972	Ⓔ, Ⓖ	Prestolite	IBM-4106	18-5298	18-5288
M318C	V8	1959-1972	Ⓔ, Ⓖ	Prestolite	IBM-4106	18-5298	18-5288
M318X	V8	1965-1966	Ⓔ, Ⓖ	Prestolite	IBM-4120	18-5298	18-5288
M413	V8	1959-1972	Ⓔ, Ⓖ	Prestolite	IBM-4106	18-5298	18-5288
M413D	V8	1959-1972	Ⓔ, Ⓖ	Prestolite	IBM-4106	18-5298	18-5288
M426X	V8	1959-1972	Ⓔ, Ⓖ	Prestolite	IBM-4106	18-5298	18-5288
M80	V8	1959-1972	Ⓔ, Ⓖ	Prestolite	IBM-4106	18-5298	18-5288
M81	V8	1959-1972	Ⓔ, Ⓖ	Prestolite	IBM-4106	18-5298	18-5288

- Ⓔ Clockwise Rotation
- Ⓕ Factory Electronic Ignition
- Ⓖ Excluding distributor number YL670AV
- Ⓔ Use with Screw Down Distributor Cap
- Ⓕ Use with Clip Down Distributor Cap
- Ⓖ Ignitor II cannot be used with solid core Ignition Wires

CRUSADER							
Model	Cylinders	Years	Footnotes	Distributor Make	Distributor #	Ignitor Kit	Ignitor II Kit
185	V8	1961-1969	①, ⑥	Mallory	YL431A	18-5296-2	18-5290
185	V8	1961-1969	①, ⑥	Mallory	YD431A	18-5296-2	18-5290
220	V8	1961-1969	①, ⑥	Mallory	YL431A	18-5296-2	18-5290
220	V8	1961-1969	①, ⑥	Mallory	YD431A	18-5296-2	18-5290
230	V8	1961-1969	⑤, ⑥	Mallory	YL431A	18-5296-2	18-5290
230	V8	1961-1969	⑤, ⑥	Mallory	YD431A	18-5296-2	18-5290
283	V8	1961-1969	①, ⑥	Prestolite	IBM-4110	18-5298	18-5288
302	V8	1975-1978	①, ⑥	Prestolite	IBM-7007	18-5298	18-5288
302	V8	1975-1978	①, ⑥	Prestolite	IBM-7007A	18-5298	18-5288
305	V8	1977-1982	①, ⑥	Prestolite	IBM-7011	18-5298	18-5288
305	V8	1977-1982	①, ⑥	Prestolite	IBM-7011C	18-5298	18-5288
305	V8	1977-1982	⑤, ⑥	Prestolite	IBM-7011D	18-5298	18-5288
305	V8	1983-1987	⑤, ⑥	Mallory	-	18-5296-2	18-5290
305	V8	1987-1988	②, ⑥	Prestolite	IDU-7801	18-5239	18-5240
327	V8	1961-1969	①, ⑥	Prestolite	IBM-4110	18-5298	18-5288
350	V8	1977-1982	①, ⑥	Prestolite	IBM-7011	18-5298	18-5288
350	V8	1977-1982	①, ⑥	Prestolite	IBM-7011C	18-5298	18-5288
350	V8	1977-1982	①, ⑥	Prestolite	IBM-7011D	18-5298	18-5288
350	V8	1983-1987	⑤, ⑥	Mallory	-	18-5296-2	18-5290
350	V8	1987-1988	②, ⑥	Prestolite	IDU-7801	18-5239	18-5240
409	V8	1961-1969	①, ⑥	Prestolite	IBM-4110	18-5298	18-5288
454	V8	1977-1982	①, ⑥	Prestolite	IBM-7011	18-5298	18-5288
454	V8	1977-1982	①, ⑥	Prestolite	IBM-7011C	18-5298	18-5288
454	V8	1977-1982	①, ⑥	Prestolite	IBM-7011D	18-5298	18-5288
454	V8	1983-1987	⑤, ⑥	Mallory	-	18-5296-2	18-5290
454	V8	1987-1988	②, ⑥	Prestolite	IDU-7801	18-5239	18-5240

DEARBORN MARINE							
Model	Cylinders	Years	Footnotes	Distributor Make	Distributor #	Ignitor Kit	Ignitor II Kit
221 CID	V8	1961-1969	3, 6	Mallory	YL362	18-5296-2	18-5290
221 CID	V8	1961-1969	3, 6	Mallory	YL455	18-5296-2	18-5290
221 CID	V8	1961-1969	3, 6	Mallory	YL519	18-5296-2	18-5290
260 CID	V8	1961-1969	3, 6	Mallory	YL362	18-5296-2	18-5290
260 CID	V8	1961-1969	3, 6	Mallory	YL455	18-5296-2	18-5290
260 CID	V8	1961-1969	3, 6	Mallory	YL519	18-5296-2	18-5290
262 CID	V8	1960-1969	3, 6	Mallory	YL350A	18-5296-2	18-5290
262 CID	V8	1960-1969	3, 6	Mallory	YL387A	18-5296-2	18-5290
272 CID	V8	1960-1969	3, 6	Mallory	YL350A	18-5296-2	18-5290
272 CID	V8	1960-1969	3, 6	Mallory	YL387A	18-5296-2	18-5290
289 CID	V8	1961-1969	3, 6	Mallory	YL362	18-5296-2	18-5290
289 CID	V8	1961-1969	3, 6	Mallory	YL455	18-5296-2	18-5290
289 CID	V8	1961-1969	3, 6	Mallory	YL519	18-5296-2	18-5290
292 CID	V8	1960-1969	3, 6	Mallory	YL350A	18-5296-2	18-5290
292 CID	V8	1960-1969	3, 6	Mallory	YL387A	18-5296-2	18-5290
312 CID	V8	1960-1969	3, 6	Mallory	YL350A	18-5296-2	18-5290
312 CID	V8	1960-1969	3, 6	Mallory	YL387A	18-5296-2	18-5290
352 CID	V8	1961-1969	3, 6	Mallory	YL362	18-5296-2	18-5290
352 CID	V8	1961-1969	3, 6	Mallory	YL455	18-5296-2	18-5290
352 CID	V8	1961-1969	3, 6	Mallory	YL519	18-5296-2	18-5290
390 CID	V8	1961-1969	3, 6	Mallory	YL362	18-5296-2	18-5290
390 CID	V8	1961-1969	3, 6	Mallory	YL455	18-5296-2	18-5290
390 CID	V8	1961-1969	3, 6	Mallory	YL519	18-5296-2	18-5290

APPLICATION CONTINUED ON NEXT PAGE

- ① Clockwise Rotation
- ② Factory Electronic Ignition
- ③ Excluding distributor number YL670AV
- ④ Use with Screw Down Distributor Cap
- ⑤ Use with Clip Down Distributor Cap
- ⑥ Ignitor II cannot be used with solid core Ignition Wires

DEARBORN MARINE

Model	Cylinders	Years	Footnotes	Distributor Make	Distributor #	Ignitor Kit	Ignitor II Kit
427 CID	V8	1965-1969	③, ⑥	Mallory	YL494A-2	18-5296-2	18-5290
427 CID	V8	1965-1969	③, ⑥	Mallory	YL494B-2	18-5296-2	18-5290

FORD MARINE

Model	Cylinders	Years	Footnotes	Distributor Make	Distributor #	Ignitor Kit	Ignitor II Kit
302 CID	V8	1973-1988	⑤, ⑥	Prestolite	IBM-7007	18-5298	18-5288
302 CID	V8	1973-1988	⑤, ⑥	Prestolite	IBM-7008	18-5298	18-5288
302 CID	V8	1973-1988	⑤, ⑥	Prestolite	IBM-7019	18-5299	18-5289
302 CID	V8	1973-1988	⑤, ⑥	Prestolite	IBM-7020	18-5299	18-5289
351 CID	V8	1973-1988	⑤, ⑥	Prestolite	IBM-7007	18-5298	18-5288
351 CID	V8	1973-1988	⑤, ⑥	Prestolite	IBM-7008	18-5298	18-5288
351 CID	V8	1973-1988	⑤, ⑥	Prestolite	IBM-7019	18-5299	18-5289
351 CID	V8	1973-1988	⑤, ⑥	Prestolite	IBM-7020	18-5299	18-5289
460 CID	V8	1973-1988	⑤, ⑥	Prestolite	IBM-7007	18-5298	18-5288
460 CID	V8	1973-1988	⑤, ⑥	Prestolite	IBM-7008	18-5298	18-5288
460 CID	V8	1973-1988	⑤, ⑥	Prestolite	IBM-7019	18-5299	18-5289
460 CID	V8	1973-1988	⑤, ⑥	Prestolite	IBM-7020	18-5299	18-5289

GRAY MARINE

Model	Cylinders	Years	Footnotes	Distributor Make	Distributor #	Ignitor Kit	Ignitor II Kit
138	V8	1950-1969	③, ⑥	Mallory	YL429	18-5296-2	18-5290
138	V8	1950-1969	③, ⑥	Mallory	YL429C	18-5296-2	18-5290
138	V8	1950-1969	③, ⑥	Mallory	YL429D	18-5296-2	18-5290
178	V8	1950-1969	③, ⑥	Mallory	YL429	18-5296-2	18-5290
178	V8	1950-1969	③, ⑥	Mallory	YL429C	18-5296-2	18-5290
178	V8	1950-1969	③, ⑥	Mallory	YL429D	18-5296-2	18-5290
401 CID	V8	ALL	③, ⑥	Mallory	YL455A	18-5296-2	18-5290
401 CID	V8	ALL	③, ⑥	Mallory	YL455A	18-5296-2	18-5290
CF175	V8	1965-1968	⑤, ⑥	Prestolite	IBM-4119	18-5298	18-5288
CF175	V8	1965-1968	⑤, ⑥	Prestolite	IBM-4119A	18-5298	18-5288
CF195	V8	1965-1968	⑤, ⑥	Prestolite	IBM-4119	18-5298	18-5288
CF195	V8	1965-1968	⑤, ⑥	Prestolite	IBM-4119A	18-5298	18-5288
CH175	V8	1965-1968	⑤, ⑥	Prestolite	IBM-4119	18-5298	18-5288
CH175	V8	1965-1968	⑤, ⑥	Prestolite	IBM-4119A	18-5298	18-5288
CH195	V8	1965-1968	⑤, ⑥	Prestolite	IBM-4119	18-5298	18-5288
CH195	V8	1965-1968	⑤, ⑥	Prestolite	IBM-4119A	18-5298	18-5288

INDMAR

Model	Cylinders	Years	Footnotes	Distributor Make	Distributor #	Ignitor Kit	Ignitor II Kit
All Models	V8	1979-1979	③, ⑥	Prestolite	IBM-7011	18-5298	18-5288

MARINE POWER

Model	Cylinders	Years	Footnotes	Distributor Make	Distributor #	Ignitor Kit	Ignitor II Kit
305 CID	V8	1978-1983	⑤, ⑥	Prestolite	IBM-7011	18-5298	18-5288
305 CID	V8	1978-1983	⑤, ⑥	Prestolite	IBM-7013	18-5299	18-5289
350 CID	V8	1978-1983	⑤, ⑥	Prestolite	IBM-7011	18-5298	18-5288
350 CID	V8	1978-1983	⑤, ⑥	Prestolite	IBM-7013	18-5299	18-5289
454 CID	V8	1978-1983	⑤, ⑥	Prestolite	IBM-7011	18-5298	18-5288
454 CID	V8	1978-1983	⑤, ⑥	Prestolite	IBM-7013	18-5299	18-5289

MERCUISER

Model	Cylinders	Years	Footnotes	Distributor Make	Distributor #	Ignitor Kit	Ignitor II Kit
110	I4	ALL	①, ⑥	Delco	-	18-5297	18-5285
120	I4	ALL	①, ⑥	Delco	-	18-5297	18-5285
140	I4	ALL	①, ⑥	Delco	-	18-5297	18-5285

APPLICATION CONTINUED ON NEXT PAGE

- ① Clockwise Rotation
- ② Factory Electronic Ignition
- ③ Excluding distributor number YL670AV
- ④ Use with Screw Down Distributor Cap
- ⑤ Use with Clip Down Distributor Cap
- ⑥ Ignitor II cannot be used with solid core Ignition Wires

MERCUISER							
Model	Cylinders	Years	Footnotes	Distributor Make	Distributor #	Ignitor Kit	Ignitor II Kit
140	V6	ALL	⑥	Delco	-	18-5294	18-5286
150	V6	ALL	⑥	Delco	-	18-5294	18-5286
160	V6	ALL	⑥	Delco	-	18-5294	18-5286
165	I4	ALL	①, ⑥	Delco	-	18-5297	18-5285
165	V6	ALL	⑥	Delco	-	18-5294	18-5286
170	I4	ALL	①, ⑥	Delco	-	18-5297	18-5285
180	I4	ALL	①, ⑥	Delco	-	18-5297	18-5285
190	I4	ALL	①, ⑥	Delco	-	18-5297	18-5285
198	V8	ALL	③, ⑥	Mallory	-	18-5296-2	18-5290
200	V6	ALL	⑥	Delco	-	18-5294	18-5286
215	V8	ALL	③, ⑥	Mallory	-	18-5296-2	18-5290
225	V8	ALL	③, ⑥	Mallory	-	18-5296-2	18-5290
228	V8	ALL	③, ⑥	Mallory	-	18-5296-2	18-5290
233	V8	ALL	③, ⑥	Prestolite	-	18-5298	18-5288
233	V8	ALL	④, ⑥	Prestolite	-	18-5299	18-5289
250	V8	ALL	③, ⑥	Mallory	-	18-5296-2	18-5290
255	V8	ALL	③, ⑥	Mallory	-	18-5296-2	18-5290
260	V8	ALL	③, ⑥	Mallory	-	18-5296-2	18-5290
280	V8	ALL	③, ⑥	Mallory	-	18-5296-2	18-5290
330	V8	ALL	③, ⑥	Mallory	-	18-5296-2	18-5290
370	V8	ALL	③, ⑥	Mallory	-	18-5296-2	18-5290
400	V8	ALL	③, ⑥	Mallory	-	18-5296-2	18-5290
440	V8	ALL	③, ⑥	Mallory	-	18-5296-2	18-5290
470	I4	ALL	①, ⑥	Delco	-	18-5297	18-5285
485	I4	ALL	①, ⑥	Delco	-	18-5297	18-5285
888	V8	ALL	③, ⑥	Prestolite	-	18-5298	18-5288
888	V8	ALL	③, ⑥	Mallory	-	18-5296-2	18-5290
898	V8	ALL	③, ⑥	Mallory	-	18-5296-2	18-5290
120 Alpha 1	V6	ALL	⑥	Delco	-	18-5294	18-5286
140 Alpha 1	V6	ALL	⑥	Delco	-	18-5294	18-5286
460 TRS	V8	ALL	③, ⑥	Mallory	-	18-5296-2	18-5290
470R	I4	ALL	①, ⑥	Delco	-	18-5297	18-5285
488R	I4	ALL	①, ⑥	Delco	-	18-5297	18-5285
5.7 Ski	V8	ALL	③, ⑥	Mallory	-	18-5296-2	18-5290

OMC

Model	Cylinders	Years	Footnotes	Distributor Make	Distributor #	Ignitor Kit	Ignitor II Kit
100HP	I4	1964-1988	①, ⑥	Delco	-	18-5297	18-5285
110HP	I4	1964-1988	①, ⑥	Delco	-	18-5297	18-5285
120HP	I4	1964-1988	①, ⑥	Delco	-	18-5297	18-5285
140HP	I4	1964-1988	①, ⑥	Delco	-	18-5297	18-5285
150HP	V6	1964-1966	⑥	Delco	1110309	18-5297	18-5285
150HP	V6	1964-1966	⑥	Delco	1110322	18-5297	18-5285
165HP	V6	1972-1976	⑥	Delco	980156	18-5297	18-5285
2.5L	I4	1982-1988	①, ⑥	Delco	982351	18-5297	18-5285
3.0L	I4	1982-1988	①, ⑥	Delco	982351	18-5297	18-5285
ALL	V8	1966-1988	③, ⑥	Mallory	-	18-5296-2	18-5290
ALL	V8	1974-1988	③, ⑥	Prestolite	980902	18-5298	18-5288
ALL	V8	1974-1988	③, ⑥	Prestolite	981080	18-5298	18-5288
ALL	V8	1974-1988	③, ⑥	Prestolite	982320	18-5298	18-5288
ALL	V8	1982-1988	④, ⑥	Prestolite	IBM-7013C	18-5299	18-5289
ALL	V8	1982-1988	④, ⑥	Prestolite	IBM-7013D	18-5299	18-5289

① Clockwise Rotation
 ② Factory Electronic Ignition
 ③ Excluding distributor number YL670AV

④ Use with Screw Down Distributor Cap
 ⑤ Use with Clip Down Distributor Cap
 ⑥ Ignitor II cannot be used with solid core Ignition Wires

ONAN

Model	Cylinders	Years	Footnotes	Distributor Make	Distributor #	Ignitor Kit	Ignitor II Kit
MDJC	I4	1961-1980	Ⓔ	Autolite	IGW-4409A	18-5295	-

PLEASURECRAFT MARINE

Model	Cylinders	Years	Footnotes	Distributor Make	Distributor #	Ignitor Kit	Ignitor II Kit
302 CID	V8	1975-1978	Ⓔ, Ⓕ	Prestolite	IBM-7007	18-5298	18-5288
302 CID	V8	1975-1978	Ⓔ, Ⓕ	Prestolite	IBM-7008	18-5298	18-5288
305 CID	V8	1976-1982	Ⓔ, Ⓕ	Prestolite	IBM-7011	18-5298	18-5288
305 CID	V8	1983-1988	Ⓔ, Ⓕ	Prestolite	IBM-7013	18-5299	18-5289
350 CID	V8	1976-1982	Ⓔ, Ⓕ	Prestolite	IBM-7011	18-5298	18-5288
350 CID	V8	1983-1988	Ⓔ, Ⓕ	Prestolite	IBM-7013	18-5299	18-5289
351 CID	V8	1975-1978	Ⓔ, Ⓕ	Prestolite	IBM-7007	18-5298	18-5288
351 CID	V8	1975-1978	Ⓔ, Ⓕ	Prestolite	IBM-7008	18-5298	18-5288
454 CID	V8	1976-1982	Ⓔ, Ⓕ	Prestolite	IBM-7011	18-5298	18-5288
454 CID	V8	1983-1988	Ⓔ, Ⓕ	Prestolite	IBM-7013	18-5299	18-5289
460 CID	V8	1975-1978	Ⓔ, Ⓕ	Prestolite	IBM-7007	18-5298	18-5288
460 CID	V8	1975-1978	Ⓔ, Ⓕ	Prestolite	IBM-7008	18-5298	18-5288

THERMO-ELECTRON

Model	Cylinders	Years	Footnotes	Distributor Make	Distributor #	Ignitor Kit	Ignitor II Kit
305 CID	V8	1977-1982	Ⓔ, Ⓕ	Prestolite	IBM-7011D	18-5298	18-5288
305 CID	V8	1981-1982	Ⓔ, Ⓕ	Prestolite	IBM-7013	18-5299	18-5289
350 CID	V8	1977-1982	Ⓔ, Ⓕ	Prestolite	IBM-7011D	18-5298	18-5288
350 CID	V8	1981-1982	Ⓔ, Ⓕ	Prestolite	IBM-7013	18-5299	18-5289
454 CID	V8	1977-1982	Ⓔ, Ⓕ	Prestolite	IBM-7011D	18-5298	18-5288
454 CID	V8	1981-1982	Ⓔ, Ⓕ	Prestolite	IBM-7013	18-5299	18-5289

UNIVERSAL

Model	Cylinders	Years	Footnotes	Distributor Make	Distributor #	Ignitor Kit	Ignitor II Kit
Atomic 4	I4	1968-1970	Ⓘ, Ⓕ	Delco	1112446	18-5297	18-5285

VOLVO PENTA

Model	Cylinders	Years	Footnotes	Distributor Make	Distributor #	Ignitor Kit	Ignitor II Kit
All Models	I4	ALL	Ⓔ	Bosch	231178017	18-5292	-
All Models	V8	1977-1982	Ⓔ, Ⓕ	Prestolite	IBM-7011A	18-5298	18-5288
All Models	V8	1977-1982	Ⓙ, Ⓕ	Prestolite	IBM-7013A	18-5299	18-5289
All Models	V8	1986-1988	Ⓙ, Ⓕ	Prestolite	IDU-7801	18-5239	18-5240

WAUKESHA

Model	Cylinders	Years	Footnotes	Distributor Make	Distributor #	Ignitor Kit	Ignitor II Kit
FC (12 Volt)	I4	1959-1973	Ⓔ	Autolite	IGW-4301-3	18-5295	-
FCS (12 Volt)	I4	1959-1973	Ⓔ	Autolite	IGW-4301-3	18-5295	-
FS (12 Volt)	I4	1959-1973	Ⓔ	Autolite	IGW-4301-3	18-5295	-
IC (12 Volt)	I4	1959-1973	Ⓘ, Ⓕ	Autolite	IGW-4301-3	18-5295	-
VGR-155	I4	1975-1978	Ⓘ, Ⓕ	Delco	1112470	18-5297	18-5285

WISCONSIN

Model	Cylinders	Years	Footnotes	Distributor Make	Distributor #	Ignitor Kit	Ignitor II Kit
VE4 (12 Volt)	I4	1948-1957	Ⓔ	Autolite	IGW Series	18-5295	-
VF4 (12 Volt)	I4	1948-1957	Ⓔ	Autolite	IGW Series	18-5295	-
VL4 (12 Volt)	I4	1948-1957	Ⓔ	Autolite	IGW Series	18-5295	-
VP4 (12 Volt)	I4	1948-1957	Ⓔ	Autolite	IGW Series	18-5295	-

- Ⓘ Clockwise Rotation
- Ⓙ Factory Electronic Ignition
- Ⓚ Excluding distributor number YL670AV
- Ⓛ Use with Screw Down Distributor Cap
- Ⓜ Use with Clip Down Distributor Cap
- Ⓨ Ignitor II cannot be used with solid core Ignition Wires

IGNITION WIRE IDENTIFICATION CHART



IGNITION WIRE LEAD TYPES

Sierra #	No. of Wires	Coil Wire	Dist. End	Spark Plug End	Coil End	Coil Dist. End
OUTBOARD IGNITION WIRES						
18-28083	1	-	1	1	-	-
18-8815-1	1	-	4	4	-	-
18-8816-1	1	-	4	4	-	-
18-8818-1	1	-	4	4	-	-
18-8819-1	1	-	11	6	-	-
18-5227-1	1	-	11	6	-	-
18-5228-1	1	-	11	6	-	-
18-5231-1	1	-	4	4	-	-
18-5229-9-1	5	-	18	4	-	-
18-5230-9-1	5	-	18	4	-	-

Sierra #	No. of Wires	Coil Wire	Dist. End	Spark Plug End	Coil End	Coil Dist. End
OUTBOARD IGNITION WIRES						
18-28084	3	-	1	1	-	-
18-28082	4	-	9	1	-	-
18-28085	4	-	1	1	-	-
18-8839-1	4	-	4	6	-	-
18-28080	6	-	9	1	-	-
18-28081	6	-	11	1	-	-
18-28086	6	-	1	1	-	-
18-28090	6	-	4	6	-	-
18-8840-1	6	-	4	6	-	-
18-8846-1	4	-	19	20	-	-

IGNITION WIRE LEAD TYPES (Continued)

Sierra #	No. of Cylinders	Coil Wire	Dist. End	Spark Plug End	Coil End	Coil Dist. End
STERNDRIVE/INBOARD IGNITION WIRES						
18-28100*	1	12	-	-	1	5
18-28101*	1	12	-	-	1	4
18-28102*	1	14	-	-	9	5
18-28042	4	12	5	1	5	5
18-28050	4	12	4	2	9	9
18-8800-1	4	13	5	2	9	5
18-8807-1	4	13	5	2	9	5
18-8808-2	4	13	5	3	9	5
18-8811-1	4	12	7	3	7	7
18-8813-1	4	20	9	14	13	13
18-8814-1	4	11/11	2	2	2	4
18-8833-1	4	9	4	1	4	4
18-8841-1	4	11	15	15/16	4	15
18-8801-1	6	13	5	2	9	5
18-8809-1	6	13	5	1	9	5
18-8810-1	6	13	6	1	10	6
18-8829-1	6	21	17	1	8	8
18-8835-1	6	15.5	4	1	4	4
18-28019	8	12/15	4	1	-	-
18-28033	8	14	4	2	5	4
18-28043	8	14	9	2	9	9
18-28044	8	12	5	3	9	9
18-28046	8	12/24	9	1	9	5
18-8802-1	8	13	5	1	9	5

Sierra #	No. of Cylinders	Coil Wire	Dist. End	Spark Plug End	Coil End	Coil Dist. End
STERNDRIVE/INBOARD IGNITION WIRES						
18-8803-1	8	13	5	1	9	5
18-8804-1	8	12	6	1	10	6
18-8805-1	8	13	5	1	9	5
18-8806-1	8	13	5	1	9	5
18-8817-1	8	12	5	2	2	2
18-8820-1	8	14	4	1	6	4
18-8821-1	8	12	6	1	5	6
18-8822-1	8	15.5	4	1	4	4
18-8823-1	8	12/17	9	1	11	5
18-8824-1	8	14	4	1	6	4
18-8825-1	8	14	5	3	11	5
18-8826-1	8	14	9	2	11	9
18-8827-1	8	9	9	1	11	9
18-8828-1	8	21	17	1	8	8
18-8830-1	8	16	4	1	10	4
18-8832-1	8	9	4	1	4	4
18-8834-1	8	12	6	1	10	6
18-8836-1	8	16	4	1	4	4
18-8837-1	8	8	1	1	10	1
18-8838-2	8	-	8	12	-	-
18-8842-1	8	9	5	3	5	5
18-8843-1	8	16	5	3	5	5
18-8844-1	8	14	4	2	6	4

Sierra #	No. of Cylinders	Coil Wire	Dist. End	Spark Plug End	Coil End	Coil Dist. End
GENERATOR IGNITION WIRES						
23-4500	3	10	5	2	5	5
23-4501	4	-	5	12	-	-



PREMIUM MARINE SPARK PLUG WIRE LEADS

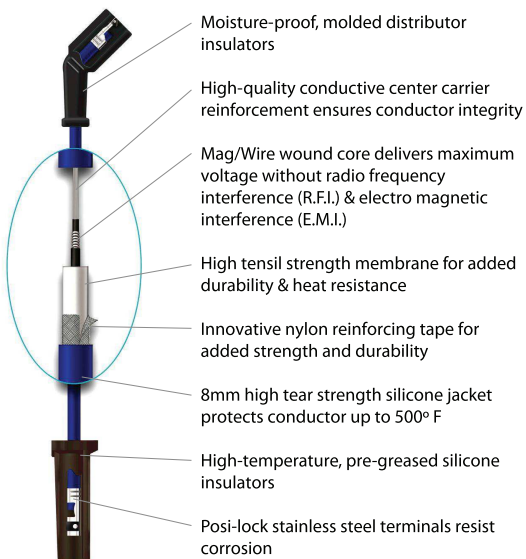

Sierra's **MAGFORCE** Ignition Wires are "Electronics Friendly" protecting all of your electronic devices and electronic engine controls from RFI and EMI while delivering the maximum amount of voltage. Exact fit design ensures easy installation and years of trouble - free service.



See application below.

PLUG WIRE SET APPLICATION CHARTS

CHRIS-CRAFT					
Engine	Cyl.	Distributor	Year Start	Year Stop	Plug Wire Set
181 CID (3.0L)	4	Conventional	ALL	ALL	18-8800-1
302	8	Conventional	ALL	ALL	18-28044
351	8	Conventional	ALL	ALL	18-28044
460	8	Conventional	ALL	ALL	18-28044
350	8	Conventional	1970	1990	18-8803-2
350	8	Conventional ❶	1970	1990	18-8823-1
454	8	Conventional	ALL	ALL	18-8817-1
502	8	Conventional	ALL	ALL	18-8817-1

❶ Models designed with Mallory side terminals

CHRYSLER					
Engine	Cyl.	Distributor	Year Start	Year Stop	Plug Wire Set
M273	8	Conventional & Electronic	1968	1974	18-8826-1
LM318	8	Conventional & Electronic	1968	1985	18-8826-1
M328	8	Conventional & Electronic	1960	1995	18-8826-1
M340	8	Conventional & Electronic	1968	1985	18-8826-1
M360	8	Conventional & Electronic	1975	1985	18-8826-1
361	8	Conventional & Electronic	1968	1985	18-8827-1
383	8	Conventional & Electronic	1960	1988	18-8827-1
400	8	Conventional & Electronic	1968	1985	18-8827-1
440	8	Conventional & Electronic	1968	1985	18-8827-1

CRUSADER-PCM					
Engine	Cyl.	Distributor	Year Start	Year Stop	Plug Wire Set
262 CID 4.3L	6	Prestolite	ALL	ALL	18-8801-1
262 CID 4.3L	6	Delco EST	ALL	ALL	18-8810-1
262 CID 4.3L	6	Delco HVS	ALL	ALL	18-8828-1
220 (305 CID 5.0L)	8	Mallory/Prestolite ❶	Up to	1987	18-8803-2
220 (305 CID 5.0L)	8	Mallory/Prestolite ❷	1987	1992	18-8803-2
270 (350 CID 5.7L)	8	Mallory/Prestolite ❶	Up to	1987	18-8803-2
270 (350 CID 5.7L)	8	Mallory/Prestolite ❷	1987	1992	18-8803-2
TB350	8	Delco EST ❸	1992	& Up	18-8824-1
5.7L Classic	8	Mallory	1999	& Up	18-8803-2
5.7L MPI Classic	8	Delco HVS	2007	& Up	18-8828-1
MP5.0L Captain's Choice	8	Delco HVS	2002	2005	18-8828-1
MP5.7L Captain's Choice	8	Delco HVS	2002	2005	18-8828-1
MP6.0L	8	Distributorless	2002	& Up	18-8838-1
350 (454 CID 7.4L)	8	Mallory ❹	Up to	1991	18-8803-2
454XL (454 CID 7.4L)	8	Delco EST ❺	1991	& Up	18-8824-1
CM454HO (454 CID 7.4L)	8	Delco EST ❻	1991	& Up	18-8824-1
454XL (454 CID 7.4L)	8	Delco EST ❼	1993	& Up	18-8824-1
MP8.1L	8	Distributorless	ALL	ALL	18-8838-1
502 (502 CID 8.2L)	8	Prestolite ❹	Up to	1991	18-8803-2
502 (502 CID 8.2L)	8	Delco EST ❹	Up to	1991	18-8824-1
502XL (502 CID 8.2L)	8	Delco EST ❻	1991	& Up	18-8824-1
TB502XL (502 CID 8.2L)	8	Delco EST ❼	1994	& Up	18-8824-1

❶ Serial Number up to 68702 ❷ Serial Number 68703-90232 ❸ Serial Number 90232 & UP ❹ Serial Number up to 88710
 ❺ Serial Number 88710 & UP ❻ Serial Number 92882 & UP ❼ Serial Number 94268 & UP

PLUG WIRE SET APPLICATION CHARTS (Cont.)

INDMAR

Engine	Cyl.	Distributor	Year Start	Year Stop	Plug Wire Set
140	8	Prestolite	Up to	1993	18-8803-2
200	8	Prestolite	Up to	1993	18-8803-2
225	8	Prestolite	Up to	1993	18-8803-2
250	8	Prestolite	Up to	1993	18-8803-2
275	8	Prestolite/Mallory	Up to	1993	18-8803-2
300	8	Prestolite/Mallory	Up to	1993	18-8803-2
350	8	Prestolite/Mallory	Up to	1993	18-8803-2
400	8	Prestolite/Mallory	Up to	1993	18-8803-2
5.7L EFI	8	Delco EST	1994	2009	18-8836-1
5.7L EFI	8	Delco HVS	2007	& Up	18-8828-1
6.0L EFI	8	Distributorless	2003	& Up	18-8838-1
6.2L EFI	8	Distributorless	2010	& Up	18-8838-1
454 Carbureted (7.4L)	8	Delco EST	1994	2011	18-8824-1
8.1L Vortec	8	Distributorless	2003	2011	18-8838-1
502 Carbureted (8.2L)	8	Delco EST	1994	2011	18-8824-1

MARINE POWER

Engine	Cyl.	Distributor	Year Start	Year Stop	Plug Wire Set
181	4	Delco	1986	1992	18-8800-1
262	6	Prestolite Ⓜ	1986	1992	18-8801-1
350	8	Prestolite Ⓜ	1986	1992	18-8802-1
350	8	Mallory	1986	1992	18-8802-1
3.0L	4	Delco EST	1993	& Up	18-8833-1
4.3L	6	Delco EST	1993	& Up	18-8835-1
5.0L	8	Delco EST	1993	2005	18-8822-1
5.0L	8	Delco HVS	2005	& Up	18-8828-1
5.7L	8	Delco EST	1993	2005	18-8822-1
5.7L	8	Delco HVS	2005	& Up	18-8828-1
7.4L	8	Delco EST	1993	2000	18-8832-1
8.2L	8	Delco EST	1993	2000	18-8832-1

Ⓜ Screw down cap

MERCURISER

Model	Cyl.	Distributor	Year Start	Year Stop	Serial # Start	Serial # End	Plug Wire Set
110	4	Delco	1963	1966	1537370	2044033	18-8800-1
120	4	Delco	1964	1986	1666601	0B531853	18-8800-1
2.5L	4	Delco	1987	1989	0B531854	0C853255	18-8800-1
140	4	Delco	1968	1986	2508261	0B450800	18-8800-1
3.0L	4	Delco	1987	1989	0B450801	0C856558	18-8800-1
3.0L, LX	4	Prestolite	1990	1991	0C856559	0D504541	18-8800-1
3.0L, LX	4	Delco Digital	1990	1991	0C856559	0D504541	18-8811-1
3.0L	4	Delco EST	1991	& Up	0D504542	& Up	18-8833-1
3.0LX	4	Delco EST	1991	1997	0D504542	0K999999	18-8833-1
3.0L MPI	4	Delco EST	2012	& Up	1A072812	& Up	18-8833-1
165	4	Delco	1987	1987	0B434940	0B774251	18-8808-2
170	4	Delco	1985	1986	6916779	0B434940	18-8808-2
180	4	Prestolite	1987	1987	0B436391	0B775248	18-8800-1
190	4	Delco	1985	1986	6916779	0B436390	18-8808-2
3.7L	4	Delco	1988	1989	0B774252	& Up	18-8808-2
3.7LX	4	Delco	1988	1989	0B775249	& Up	18-8808-2
3.7LX	4	Prestolite	1988	1989	0B775249	& Up	18-8800-1
470	4	Delco	1976	1984	4208370	6916778	18-8808-2
485	4	Delco	1980	1982	5685394	6218036	18-8808-2

MERCURISER CONTINUED ON NEXT PAGE

PLUG WIRE SET APPLICATION CHARTS (Cont.)

MERCURISER							
Model	Cyl.	Distributor	Year Start	Year Stop	Serial # Start	Serial # End	Plug Wire Set
488	4	Delco	1981	1984	6170297	6916778	18-8808-2
140	L6	Delco	1963	1963	1538930	1725960	18-8809-1
150	L6	Delco	1964	1966	1666495	2048046	18-8809-1
160	L6	Delco	1967	1969	2048022	2770031	18-8809-1
165	L6	Delco	1970	1981	2770032	5813433	18-8809-1
200	L6	Delco	1969	1969	2453769	2712072	18-8809-1
185	6	Prestolite	1983	1984	6330183	6919655	18-8801-1
175	6	Thunderbolt IV	1987	1987	0B527955	0B773242	18-8810-1
185	6	Thunderbolt IV	1985	1987	6919656	0B527954	18-8810-1
205	6	Thunderbolt IV	1985	1987	0A331445	0B775129	18-8810-1
262 Mag	6	Delco EST	1996	1997	0F803800	0K999999	18-8835-1
4.3L	6	Thunderbolt IV	1988	1996	0B773243	0F802999	18-8810-1
4.3L Alpha	6	Thunderbolt V	1998	& Up	0L010044	& Up	18-8810-1
4.3L Bravo	6	Thunderbolt V	1998	& Up	0L010044	& Up	18-8810-1
4.3L EFI	6	Delco EST	1998	1998	0L012009	0L359999	18-8835-1
4.3L EFI	6	Thunderbolt V	1999	2004	0L360000	&Up	18-8810-1
4.3L MPI	6	Delco HVS	2001	& Up	0M300000	& Up	18-8829-1
4.3LH Alpha	6	Thunderbolt V	1998	2004	0L010044	& Up	18-8810-1
4.3LH Bravo	6	Thunderbolt V	1998	2004	0L010044	& Up	18-8810-1
4.3LX, LXH	6	Thunderbolt IV	1988	1997	0B775130	0K999999	18-8810-1
215 MCM & MIE (Ford)	8	Autolite/Mallory	1970	1972	2781153	3563181	18-8803-2
225 MCM & MIE (Ford)	8	Autolite/Mallory/Mercury	1973	1974	3385721	4166999	18-8803-2
888 (Ford)	8	Autolite/Mallory	1971	1977	3108723	4887829	18-8803-2
190 (GM)	8	Delco	1963	1964	1564539	1730903	18-8803-2
198 MIE	8	Mallory	1977	1977	4776402	4931099	18-8803-2
200	8	Thunderbolt IV	1985	1987	6899058	8774444	18-8821-1
228	8	Mallory	1977	1982	4765100	6218461	18-8803-2
228	8	Thunderbolt IV	1983	1984	6218462	6899268	18-8821-1
228 MIE	8	Mallory	1977	1980	4765100	5907057	18-8803-2
230	8	Thunderbolt IV	1985	1987	6899269	0B773739	18-8821-1
230 MIE (LH)	8	Thunderbolt IV	1981	1987	5907058	0B788151	18-8821-1
230 MIE (RH)	8	Thunderbolt IV	1981	1987	5907058	0B788151	18-8821-1
5.0L	8	Thunderbolt IV	1988	1995	0B774445	0F600999	18-8821-1
5.0L Alpha	8	Thunderbolt V	1998	& Up	0L015751	& Up	18-8821-1
5.0L Bravo	8	Thunderbolt V	1998	& Up	0L015751	& Up	18-8821-1
5.0L EFI	8	Delco EST	1998	1998	0L012052	0L339999	18-8822-1
5.0L MIE (LH)	8	Thunderbolt IV	1988	1988	0B788152	0C396832	18-8821-1
5.0L MIE (RH)	8	Thunderbolt IV	1988	1988	0B788152	0C396832	18-8821-1
5.0L MPI Alpha	8	Delco HVS	2001	& Up	0M300000	& Up	18-8828-1
5.0LX	8	Thunderbolt IV	1988	1995	0B773740	0F600999	18-8821-1
898	8	Mallory	1977	1982	4762210	6218461	18-8803-2
898	8	Thunderbolt IV	1983	1984	6218462	6899057	18-8821-1
225 (GM)	8	Delco	1963	1969	1539620	2694014	18-8803-2
225 MIE (GM)	8	Thunderbolt	1968	1968	2278647	2694014	18-8803-2
250 MCM & MIE	8	Thunderbolt	1968	1969	2314301	2639854	18-8803-2
250	8	Mallory	1977	1977	4768000	4908849	18-8803-2
255 MCM & MIE	8	Mallory	1975	1976	3258728	4501254	18-8803-2
255 MCM & MIE	8	Mercury	1976	1976	4498701	4767999	18-8803-2
255 MIE	8	Mercury	1977	1980	4768000	5907057	18-8803-2
260	8	Mallory	1978	1982	4908850	6218461	18-8803-2
260	8	Thunderbolt IV	1982	1987	6218462	0B773304	18-8821-1
260 MIE (LH)	8	Thunderbolt IV	1981	1986	5907058	0B788151	18-8821-1
260 MIE (RH)	8	Thunderbolt IV	1981	1986	5907058	0B788151	18-8821-1

MERCURISER CONTINUED ON NEXT PAGE

PLUG WIRE SET APPLICATION CHARTS (Cont.)

MERCURISER

Model	Cyl.	Distributor	Year Start	Year Stop	Serial # Start	Serial # End	Plug Wire Set
270 MCM & MIE	8	Thunderbolt	1969	1972	2851074	3385720	18-8803-2
280 TRS	8	Mercury/Mallory	1975	1975	4176250	4499390	18-8803-2
300	8	Thunderbolt IV	1985	1986	6668677	0B430367	18-8821-1
320 EFI	8	Thunderbolt IV	1987	1989	0A543604	0C622418	18-8821-1
350 Mag Alpha	8	Thunderbolt IV	1986	1994	0A635178	0F353690	18-8821-1
350 Mag Alpha	8	Thunderbolt V	1995	1997	0F353691	0K999999	18-8821-1
350 Mag Alpha EFI	8	Delco EST	1996	1997	0F800300	0K999999	18-8822-1
350 Mag Bravo MPI	8	Delco EST	1995	1996	0F415189	0K999999	18-8822-1
350 Mag EFI Ski	8	Delco EST	1994	1997	0F215561	0K999999	18-8822-1
350 Mag MPI	8	Delco EST	1998	1998	0L010019	0L325952	18-8822-1
350 Mag MPI Alpha	8	Delco HVS	2001	& Up	0M300000	& Up	18-8828-1
350 Mag MPI Bravo	8	Delco HVS	2001	& Up	0M300000	& Up	18-8828-1
350 Mag MPI Horizon	8	Delco HVS	2001	& Up	0M300000	& Up	18-8828-1
350 Mag MPI Horizon MIE	8	Delco HVS	2001	& Up	0M300000	& Up	18-8828-1
350 Mag MPI MIE	8	Delco HVS	2001	& Up	0M300000	& Up	18-8828-1
350 Mag MPI Ski	8	Thunderbolt IV	1991	1996	0D505450	0K40399	18-8821-1
350 Mag MPI Ski	8	Thunderbolt V	1991	1997	0D505450	0K999999	18-8821-1
5.7L Alpha	8	Thunderbolt IV	1988	1995	0B773305	0F600999	18-8821-1
5.7L Alpha	8	Thunderbolt V	1996	1997	0F601000	& Up	18-8821-1
5.7L Bravo	8	Thunderbolt IV	1988	1993	0B773305	0F353524	18-8821-1
5.7L Bravo	8	Thunderbolt V	1994	& Up	0F353525	& Up	18-8821-1
5.7L EFI	8	Delco EST	1995	1998	0F225560	0L339999	18-8822-1
5.7L EFI MIE	8	Delco EST	1997	1997	0K040300	0K999999	18-8822-1
5.7L MIE	8	Thunderbolt IV	1988	1995	0B788152	0F746099	18-8821-1
5.7L MIE	8	Thunderbolt V	1996	1997	0F622100	0K999999	18-8821-1
5.7L MIE	8	Thunderbolt V	1998	& Up	0L002003	& Up	18-8821-1
5.7L Ski	8	Mallory/Prestolite	1985	1995	0A338553	0F775199	18-8802-1
5.7L Ski	8	Thunderbolt IV	1987	1995	0B514627	0F775199	18-8821-1
5.7L Ski	8	Thunderbolt V	1996	1997	0F775200	0K999999	18-8821-1
5.7L Ski	8	Thunderbolt V	1998	& Up	0L002005	& Up	18-8821-1
5.7LX Alpha & Bravo	8	Thunderbolt V	1996	1997	0F601000	0K999999	18-8821-1
5.7LX Bravo & EFI	8	Delco EST	1996	1997	0F752400	0K999999	18-8822-1
233 MCM & MIE (Ford)	8	Mercury/Prestolite	1975	1977	4173000	4902304	18-8803-2
255 MCM & MIE (Ford)	8	Mercury/Mallory	1973	1980	3258728	5907057	18-8803-2
MX 6.2L MPI	8	Delco HVS	2001	& Up	0M300000	& Up	18-8828-1
MX 6.2L MPI Horizon	8	Delco HVS	2001	& Up	0M300000	& Up	18-8828-1
MX 6.2L MPI Horizon MIE	8	Delco HVS	2001	& Up	0M300000	& Up	18-8828-1
MX 6.2L MPI MIE	8	Delco HVS	2001	& Up	0M300000	& Up	18-8828-1
377 MAG MPI BRAVO	8	Delco HVS	ALL	ALL	1A300000	& Up	18-8828-1
325 MCM & MIE	8	Thunderbolt	1969	1974	2278747	& Up	18-8803-2
325 MCM & MIE	8	Mallory	1969	1972	2278747	& Up	18-8803-2
390	8	Mallory	1968	1970	ALL		18-8803-2
330	8	Mallory	1977	1981	4623115	6083144	18-8803-2
330	8	Thunderbolt	1977	1981	4623115	6083144	18-8803-2
330	8	Thunderbolt IV	1982	1987	6083145	0B816540	18-8821-1
340 MIE	8	Thunderbolt IV	1981	1987	5889914	0B788365	18-8821-1
350 MIE	8	Thunderbolt	1974	1976	3780450	4623109	18-8803-2
370 TRS	8	Mallory/Holley	1978	1985	4179554	6721527	18-8803-2
370 TRS	8	Thunderbolt IV	1985	1987	6721528	0B714586	18-8821-1
400 TRS	8	Mallory/Holley	1980	1986	5668232	0B457644	18-8803-2
440 TRS	8	Mallory/Holley	1983	1986	6181070	0B485220	18-8803-2
450	8	Thunderbolt IV	1995	1996	0F347100	0F347277	18-8821-1
454 Mag Alpha	8	Thunderbolt IV	1986	1988	0A631894	0B785148	18-8821-1

MERCURISER CONTINUED ON NEXT PAGE

PLUG WIRE SET APPLICATION CHARTS (Cont.)

MERCURISER							
Model	Cyl.	Distributor	Year Start	Year Stop	Serial # Start	Serial # End	Plug Wire Set
454 Mag Bravo	8	Thunderbolt IV	1988	1997	0B721206	0K999999	18-8821-1
454 Mag EFI	8	Delco EST	1994	1996	0F115700	0F802349	18-8822-1
454 Mag MPI	8	Delco EST	1996	2001	0F802350	M024999	18-8822-1
454 Mag MPI Horizon MIE	8	Delco EST	1999	2001	0L002200	0L674000	18-8822-1
454 Mag MPI Ski	8	Delco EST	1995	1997	0F215800	0K999999	18-8822-1
7.4L Bravo I, II, III	8	Thunderbolt IV	1988	1997	0B771113	0K999999	18-8821-1
7.4L Bravo III	8	Thunderbolt V	1992	1997	603118	0K999999	18-8821-1
7.4L EFI MIE	8	Thunderbolt IV	1988	1996	0B788366	0F820141	18-8821-1
7.4L MIE	8	Thunderbolt IV	1988	1996	0B788366	0F820141	18-8821-1
7.4L MIE	8	Thunderbolt V	1992	1997	0D715494	0K999999	18-8821-1
7.4L MPI (L29)	8	Delco EST	1998	2001	0L010003	0M024330	18-8822-1
7.4L MPI MIE	8	Delco EST	1995	2001	0F563052	0M025999	18-8822-1
7.4LX Bravo EFI & MPI	8	Delco EST	1996	1997	0F602010	0K999999	18-8822-1
390	8	Thunderbolt	1969	1970	2781129	2825059	18-8803-2
460 TRS	8	Mallory/Holley	1983	1986	6180970	6181046	18-8803-2
460 Cyclone	8	ALL	1983	1985	ALL		18-8803-2
496 Mag & Mag HO	8	Delco (coil over plug)	2000	& Up	0M025000	& Up	18-8838-1
8.1 MIE & HO MIE	8	Delco (coil over plug)	2000	& Up	0M025000	& Up	18-8838-1
502 Mag Bravo	8	Thunderbolt IV	1990	1993	0G878221	0F114528	18-8821-1
502 Mag EFI	8	Delco EST	1993	1996	0B40650	0F802599	18-8822-1
502 Mag MPI	8	Delco EST	1996	2001	0F802600	0M024999	18-8822-1
525 SC	8	Thunderbolt IV	1991	1995	0D456000	0F877734	18-8821-1
8.2L MIE	8	Thunderbolt IV	1990	1996	0C878221	0F819619	18-8821-1
8.2L MPI MIE	8	Delco EST	1996	2001	0F819620	0L674200	18-8822-1

OMC

Engine	Cyl.	Distributor	Year Start	Year Stop	Plug Wire Set
2.3L	4	Mallory	1987	1990	18-8807-1
2.3L	4	Prestolite	1990	1990	18-8807-1
2.5L	4	Delco	1981	1986	18-8800-1
3.0L	4	Delco	1982	1990	18-8800-1
3.0L	4	Delco EST	1990	1998	18-8833-1
3.8L	6	Prestolite	1981	1985	18-8801-1
4.3L	6	Prestolite ②	1985	1990	18-8801-1
4.3L	6	Prestolite	1991	1993	18-8801-1
4.3L	6	Delco EST	1994	1998	18-8835-1
5.0L (GM)	8	Prestolite ①	1979	1982	18-8802-1
5.0L (GM)	8	Mallory	1981	1988	18-8802-1
5.0L (GM)	8	Prestolite ②	1983	1988	18-8802-1
5.0L (Ford)	8	Prestolite ②	1989	1990	18-8806-1
5.0L (Ford)	8	Prestolite	1991	1996	18-8806-1
5.0L (Ford)	8	Ford HEI	1993	1996	18-8820-1
5.0L (GM)	8	Prestolite	1998	1998	18-8801-1
5.0L (GM)	8	Delco EST	1998	1998	18-8822-1
5.7L	8	Mallory	1982	1990	18-8802-1
5.7L	8	Prestolite ②	1982	1990	18-8802-1
5.7L	8	Prestolite ②	1991	1998	18-8802-1
5.7L	8	Delco EST	1996	1998	18-8822-1
5.8L	8	Prestolite ②	1989	1990	18-8842-1
5.8L	8	Prestolite ②	1991	1996	18-8842-1
5.8L	8	Ford HEI	1993	1996	18-8820-1
7.4L	8	Mallory	1988	1988	18-8802-1

OMC CONTINUED ON NEXT PAGE

PLUG WIRE SET APPLICATION CHARTS (Cont.)

OMC

Engine	Cyl.	Distributor	Year Start	Year Stop	Plug Wire Set
7.4L	8	Prestolite ②	1988	1988	18-8802-1
7.4L	8	Distributorless	1990	1991	18-8843-1
7.4L	8	Delco EST	1995	1998	18-8832-1
7.5L	8	Prestolite ②	1987	1987	18-8803-2
7.5L	8	Prestolite ②	1987	1989	18-8803-2
8.2L	8	Mallory	1984	1985	18-8802-1
8.2L	8	Prestolite ②	1984	1985	18-8802-1
8.2L	8	Delco EST	1998	1998	18-8832-1
80	4	ALL	1962	1968	18-8800-1
90	4	ALL	1962	1968	18-8800-1
100	4	Delco	1972	1973	18-8800-1
110	4	Delco	1964	1964	18-8800-1
120	4	Delco	1965	1981	18-8800-1
140	4	Delco	1973	1981	18-8800-1
170	8	Prestolite ①	1974	1974	18-8802-1
175	8	Prestolite ①	1975	1977	18-8802-1
185	8	Mallory	1967	1968	18-8802-1
185	8	Mallory	1978	1980	18-8802-1
185	8	Prestolite ①	1978	1980	18-8802-1
190	8	Prestolite ①	1974	1977	18-8802-1
200	8	Mallory	1979	1988	18-8802-1
200	8	Prestolite ①	1979	1981	18-8802-1
210	8	Mallory	1968	1970	18-8802-1
215	8	Mallory	1971	1971	18-8802-1
225	8	Mallory	1972	1976	18-8802-1
225	8	Mallory	1978	1978	18-8802-1
230	8	Mallory	1979	1981	18-8802-1
230	8	Prestolite ①	1979	1981	18-8802-1
230	8	Mallory	1975	1976	18-8802-1
235	8	Mallory	1971	1971	18-8802-1
235	8	Prestolite ①	1975	1977	18-8802-1
240	8	Prestolite ①	1978	1978	18-8802-1
245	8	Mallory	1975	1975	18-8802-1
250	8	Mallory	1970	1974	18-8802-1
250	8	Prestolite ①	1979	1979	18-8802-1
260	8	Mallory	1975	1976	18-8802-1
260	8	Mallory	1979	1981	18-8802-1
260	8	Prestolite ①	1979	1981	18-8802-1
290 JET	8	Mallory	1974	1975	18-8802-1
305	8	Mallory	1977	1979	18-8802-1
305	8	Mallory	1980	1981	18-8802-1
305	8	Prestolite ①	1981	1981	18-8802-1
350	8	Mallory	1977	1979	18-8802-1
350	8	Mallory	1980	1981	18-8802-1
350	8	Prestolite ①	1981	1981	18-8802-1
454	8	Mallory	1977	1979	18-8803-2
454	8	Mallory	1980	1981	18-8803-2
454	8	Prestolite ①	1981	1981	18-8803-2

① Clip down cap ② Snap down cap

VOLVO

Model	Cyl.	Distributor	Year Start	Year End	Plug Wire Set
AQ115A, B	4	Volvo	1969	1975	18-28050

VOLVO CONTINUED ON NEXT PAGE

PLUG WIRE SET APPLICATION CHARTS (Cont.)

VOLVO					
Model	Cyl.	Distributor	Year Start	Year End	Plug Wire Set
AQ120B	4	Volvo	1977	1980	18-8813-1
AQ125A, B	4	Volvo	1981	1985	18-8813-1
AQ130A, B, C, D	4	Volvo	1968	1977	18-28050
AQ131A, B, C, D	4	Volvo	1985	1989	18-8813-1
AQ140A	4	Volvo	1975	1979	18-8813-1
AQ145A, B	4	Volvo	1979	1985	18-8813-1
AQ151A, B, C	4	Volvo	1985	1989	18-8813-1
AQ175A	6	Volvo	1981	1985	18-8801-1
AQ190A	8	Volvo	1976	1977	18-8802-1
AQ200B	8	Mallory (Tall Cap)	1974	1976	18-8802-1
AQ200B	8	Mallory (Flat Cap)	1974	1976	18-8823-1
AQ200C	8	Mallory (Tall Cap)	1976	1977	18-8802-1
AQ200C	8	Mallory (Flat Cap)	1976	1977	18-8823-1
AQ205A	6	Volvo	1988	1989	18-8801-1
AQ211A	8	Volvo	1986	1989	18-8802-1
AQ225B	8	Mallory (Tall Cap)	1974	1976	18-8802-1
AQ225B	8	Mallory (Flat Cap)	1974	1976	18-8823-1
AQ231A, B	8	Volvo	1986	1989	18-8802-1
AQ240A	8	Volvo	1976	1977	18-8802-1
AQ255A	8	Mallory (Flat Cap)	1977	1978	18-8823-1
AQ255B	8	Mallory (Tall Cap)	1978	1978	18-8802-1
AQ255B	8	Mallory (Flat Cap)	1978	1978	18-8823-1
AQ260A	8	Mallory (Tall Cap)	1979	1985	18-8802-1
AQ260A	8	Mallory (Flat Cap)	1979	1985	18-8823-1
AQ260B	8	Mallory (Tall Cap)	1985	1986	18-8802-1
AQ271A, B, C, D	8	Volvo	1986	1989	18-8802-1
AQ280A	8	Mallory (Tall Cap)	1978	1979	18-8802-1
AQ280A	8	Mallory (Flat Cap)	1978	1979	18-8823-1
AQ290A	8	Mallory (Tall Cap)	1979	1985	18-8802-1
AQ290A	8	Mallory (Flat Cap)	1979	1985	18-8823-1
AQ311A, B	8	Volvo	1986	1989	18-8802-1
BB140A	4	Volvo	1975	1979	18-8813-1
BB145A	4	Volvo	1979	1985	18-8813-1
BB225A, AV, B, C	8	Volvo	1973	1977	18-8802-1
BB231A	8	Volvo	1987	1987	18-8802-1
BB260A, AV, B, C	8	Volvo	1978	1985	18-8802-1
BB261A	8	Volvo	1988	1989	18-8802-1
230A, B	4	Volvo	1989	1992	18-8813-1
250A, B	4	Volvo	1989	1992	18-8813-1
432A	6	Delco EST	1992	1993	18-8835-1
434A	6	Delco EST	1992	1993	18-8835-1
3.0GLM	4	Delco EST	1993	1994	18-8833-1
3.0GLM	4	Delco EST	2002	2004	18-8833-1
3.0GLP	4	Delco EST	2002	2010	18-8833-1
3.0GSM	4	Delco EST	1994	2002	18-8833-1
3.0GSP	4	Delco EST	1993	2002	18-8833-1
3.0GXI	4	Delco EST	2008	2009	18-8833-1
4.3GI	6	Delco EST	1994	2000	18-8835-1
4.3GL	6	Delco EST	1993	2010	18-8835-1
4.3GS	6	Delco EST	1993	1999	18-8835-1
4.3GXI	6	Delco HVS	2001	2015	18-8829-1
4.3GXI	6	Delco EST	2001	2002	18-8835-1
4.3GXIE	6	Delco HVS	2009	2015	18-8829-1

VOLVO CONTINUED ON NEXT PAGE

PLUG WIRE SET APPLICATION CHARTS (Cont.)

VOLVO

Model	Cyl.	Distributor	Year Start	Year End	Plug Wire Set
4.3SI	6	Delco HVS	2001	2009	18-8829-1
4.3SI-BF	6	Delco HVS	2001	2002	18-8829-1
5.0FI	8	Ford	1994	1996	18-8820-1
5.0FL	8	Prestolite	1994	1996	18-8802-1
5.0GI	8	Delco EST	1997	2000	18-8836-1
5.0GL	8	Prestolite	1997	2001	18-8802-1
5.0GL	8	Delco EST	2001	2006	18-8836-1
5.0GX1	8	Delco HVS	2001	2015	18-8828-1
5.0GX1-A	8	Delco EST	2001	2002	18-8836-1
5.0GXIC	8	Delco HVS	2007	2009	18-8828-1
5.0GXIE	8	Delco HVS	2007	2015	18-8828-1
5.0OSI	8	Delco HVS	2001	2009	18-8828-1
5.0OSIE	8	Delco HVS	2008	2009	18-8828-1
5.7GI	8	Delco EST	1993	1997	18-8836-1
5.7Gi	8	Delco HVS	2001	2015	18-8828-1
5.7GI	8	Delco EST	2004	2005	18-8836-1
5.7GiC	8	Delco HVS	2008	2009	18-8828-1
5.7GiCE	8	Delco HVS	2008	2009	18-8828-1
5.7GiE	8	Delco HVS	2007	2015	18-8828-1
5.7GIL	8	Delco HVS	2002	2009	18-8828-1
5.7GIL-A	8	Delco EST	2001	2001	18-8836-1
5.7GL	8	Prestolite	1993	1997	18-8802-1
5.7GL	8	Delco EST	1993	1997	18-8836-1
5.7GL	8	Delco EST	2001	2004	18-8836-1
5.7GL-A	8	Mallory	2001	2001	18-8802-1
5.7GSI	8	Delco EST	1996	2001	18-8836-1
5.7GSP	8	Prestolite	1996	2000	18-8802-1
5.7GX1	8	Delco HVS	2001	2015	18-8828-1
5.7GX1-A, B	8	Delco EST	2000	2002	18-8836-1
5.7GXIC	8	Delco HVS	2007	2008	18-8828-1
5.7GXICE	8	Delco HVS	2007	2010	18-8828-1
5.7GXIE	8	Delco HVS	2007	2015	18-8828-1
5.7GXIL	8	Delco HVS	2001	2008	18-8828-1
5.7GXIL-A, B	8	Delco EST	2000	2002	18-8836-1
5.7OSi	8	Delco HVS	2001	2009	18-8828-1
5.7OSiE	8	Delco HVS	2008	2009	18-8828-1
5.7OSX1	8	Delco HVS	2001	2009	18-8828-1
5.7OSXIE	8	Delco HVS	2008	2009	18-8828-1
5.8FI	8	Ford	1994	1996	18-8820-1
5.8FL	8	Prestolite	1994	1996	18-8803-1
5.8FSI	8	Prestolite	1994	1996	18-8803-1
7.4GI	8	Delco EST	1994	2000	18-8836-1
7.4GL	8	Prestolite	1993	1997	18-8802-1
7.4GLI	8	Prestolite	1993	1996	18-8802-1
7.4GLP	8	Prestolite	1993	1997	18-8802-1
7.4GLP	8	Prestolite	1994	1997	18-28051
7.4GLP	8	Delco EST	1995	1996	18-8836-1
7.4GSI	8	Delco EST	1994	2000	18-8836-1
8.1Gi-A	8	Distributorless	1999	2015	18-8838-1
8.1GiC	8	Distributorless	2007	2015	18-8838-1
8.1GiCE	8	Distributorless	2007	2015	18-8838-1
8.1GiE	8	Distributorless	2007	2015	18-8838-1
8.1GiL	8	Distributorless	2000	2008	18-8838-1

VOLVO CONTINUED ON NEXT PAGE

PLUG WIRE SET APPLICATION CHARTS (Cont.)

VOLVO					
Model	Cyl.	Distributor	Year Start	Year End	Plug Wire Set
8.1GSI	8	Distributorless	2000	2001	18-8838-1
8.1GXl	8	Distributorless	2001	2015	18-8838-1
8.1GXIE	8	Distributorless	2007	2015	18-8838-1
8.1GXil	8	Distributorless	2001	2008	18-8838-1
8.1IPSCE	8	Distributorless	2008	2015	18-8838-1
8.1OSI	8	Distributorless	2003	2009	18-8838-1
8.1OSIE	8	Distributorless	2008	2009	18-8838-1
8.2GLI	8	Prestolite	1993	1994	18-8803-1
8.2GLP	8	Prestolite	1993	1994	18-8803-1
8.2GSI	8	Delco EST	1995	2000	18-8836-1
DPX375	8	Distributorless	2000	2002	18-8838-1
DPX385	8	Delco EST	1996	2000	18-8836-1
DPX415	8	Delco EST	1996	2000	18-8836-1
DPX420	8	Distributorless	2000	2002	18-8838-1
V6-200	6	Delco HVS	2012	2015	18-8828-1
V6-225	6	Delco HVS	2012	2015	18-8828-1
V8-270	8	Delco HVS	2012	2015	18-8829-1
V8-300	8	Delco HVS	2012	2015	18-8829-1
V8-320	8	Delco HVS	2012	2015	18-8829-1

YAMAHA STERNDRIVE					
Model	Cyl.	Distributor	Year Start	Year End	Plug Wire Set
3.0L	4	Delco EST	1990	1993	18-8835-1
4.3L	6	YEMS	1989	1989	18-8835-1
4.3L	6	Delco EST	1990	1990	18-8835-1
5.0L	8	YEMS	1989	1989	18-8836-1
5.7L	8	Delco EST	1989	1990	18-8836-1
7.4L	8	Delco EST	1992	1992	18-8836-1



 <p>18-5013 TUNE-UP KIT — CONTAINS — Part # Desc. O.E.# 18-5149 Contact Set F12044 18-5169 Condenser F12042-1</p>	 <p>18-5149 CONTACT SET Replaces: F12044, FP2437A</p>	 <p>18-5150 CONTACT SET Replaces: FA305310-2, 817764A2</p>	 <p>18-5169 CONDENSER Replaces: F12042-1</p>
 <p>18-5241 CONDENSER Replaces: F12181-1</p>	  <p>18-5803 SOLENOID Replaces: F177917</p>	 <p>18-5835 SOLENOID Replaces: 89-803822T, 89-F460917-1, F460917-1, 89-817109A3 For: Early model 35-150 HP</p>	 <p>18-5834 SOLENOID Replaces: 89-817109A2 For: 75 HP (3 cyl.) S/N G127500 & UP</p>

 <p>18-5775 SWITCH BOX Replaces: 332-7778A12</p>	 <p>18-5881 SWITCH BOX Replaces: 332-5772A7, 332-5772A5</p>	 <p>18-5790 SWITCH BOX ASSEMBLY Replaces: 18495A26</p>
--	---	--

 <p>18-5870 STATOR Replaces: 398-832075A4</p>	 <p>18-5873 STATOR & KIT Replaces: 398-832075A6 For: 100, 115, 125 HP</p>	 <p>18-5186 IGNITION COIL Replaces: 339-7370A13, 339-7370B13, 339-832757B4</p> <p>① 18-5186D Display Package</p>
---	--	---

COIL & STATOR APPLICATION

Year	HP	S/N	Coil	Stator	Year	HP	S/N	Coil	Stator
1992-95	40/50	E000001-E138599	18-5186	—	1990-95	120	ALL	18-5186	—
1996-99	40/50	E138600-E369299	—	18-5870	1994-95	120	E065487-E138599	18-5186	18-5873
1991-95	70	E000001-E138599	18-5186	—	1994-95	SPORT JET 120	E095088-E141088	18-5186	18-5873
1996-99	75	E138600-UP	—	18-5870	1996-99	120	E138600-UP	—	18-5870
1991-95	90	E000001-E138599	18-5186	—	1989-94	150	ALL	18-5186	—
1996-99	90	E138600-UP	—	18-5870					

CHRYSLER IGNITION

HP	Model	Contact Set	Condenser	Tune-Up Kit	Starter Solenoid	HP	Model	Contact Set	Condenser	Tune-Up Kit	Starter Solenoid
4.5	42HA	—	18-5241	—	N/A	9.9	92H1H,H1J,H2J,H3K	—	18-5241	—	N/A
4.9	44HA,44/45HB, HC, HD	—	18-5241	—	N/A	9.9 [ⓐ]	92/93H9F,98/99H9A	—	18-5241	—	N/A
5	52/53HA	—	18-5241	—	N/A	9.9	92/93HA-HE,H0G, 94H1F	—	18-5241	—	N/A
5	54/55HA, HB, HC, HD	—	18-5241	—	N/A	9.9 [ⓑ]	94/95HA	—	18-5241	—	18-5803
6	60HA,62/63HA-HH, H9M	—	18-5241	—	N/A	9.9 [ⓐ]	94/95HA-HE	—	18-5241	—	N/A
6	64HA-HC, H0F, H1G, H2H, H8D, H9E	—	18-5241	—	N/A	10 [ⓐ]	102/103HD,H8B, 108/109HA,H8B	—	18-5241	—	—
7	72/73HA	—	18-5241	—	N/A	10	102/103/104/105HA, HB, HC	—	18-5241	—	N/A
8	82/83HA-HH,H9K	—	18-5241	—	N/A	12.9	122/123H9E, 128/129H9A	—	18-5241	—	—

① Items ending in "D" are Display Packaged - Regular number is Non-Display

APPLICATION CONTINUED ON NEXT PAGE

CHRYSLER IGNITION (Cont.)

HP	Model	Contact Set	Condenser	Tune-Up Kit	Starter Solenoid	HP	Model	Contact Set	Condenser	Tune-Up Kit	Starter Solenoid
12.9	122/123/124/125HA, HC, HD	—	18-5241	—	N/A	35③	356/357HA-HF	18-5162	—	—	18-5803
15	152H1G, H1H, H2H, H3J	—	18-5241	—	N/A	35	360/361HA, HB	18-5149	18-5169	18-5013	—
15	152/153HA, HB, H0F	—	18-5241	—	N/A	45③	450 THRU 457HA, HC-HH	18-5162	—	—	18-5803
15①	152/153HC, H8D, H9E	—	18-5241	—	—	45②	450 THRU 457HA, HC-HH	18-5149	18-5169	18-5013	18-5803
15	154/155HA, 154HB	—	18-5241	—	N/A	45①	450 THRU 457HC-HH	18-5162	N/A	N/A	18-5803
15	158/159HA, H8B, H9C	—	18-5241	—	—	45	450/451HK, 452/453HC-HJ, H8K	18-5149	18-5169	18-5013	—
20	202H2N, 202/203HA-HG, H0L	—	18-5241	—	N/A	45	456/7H0L, HJ, H1M, H9K, 457H3P, H2N	18-5162	—	—	18-5803
20①	202/203H1M, H9K	—	18-5241	—	—	45	458/459HA, HG	18-5162	N/A	N/A	18-5803
20	204/205HA-HG	—	18-5241	—	N/A	45③	458/459HA-HF	18-5162	—	—	18-5803
20①	206/207H9B	—	18-5241	—	—	45①	458/459HA-HF	18-5162	N/A	N/A	18-5803
25	252H1F, H2F, H3G, 252/253H8C	—	18-5241	—	N/A	45②	458/459HA-HF	18-5149	18-5169	18-5013	18-5803
25②	252/253HB, H8D, 254/255HB	—	18-5241	—	N/A	45	459H0J, H9H	18-5162	—	—	18-5803
25	252/253/254/255HA	—	18-5241	—	N/A	45	464HA	18-5149	18-5169	18-5013	18-5803
25③	252/253/254/255HB, 256/257HA	18-5162	—	—	—	50	503H3A, 507H1A, H2B, H2C, H3D, R3E	18-5162	—	—	18-5803
25②	256/257HA, H8C	—	18-5241	—	N/A	55	551HA	18-5162	—	—	18-5803
30②	302/303H9C, HB	—	18-5241	—	N/A	55②	554 THRU 559HA, HC-HG	18-5149	18-5169	18-5013	18-5803
30	302/303/304/305HA	—	18-5241	—	N/A	55③	554 THRU 559HA, HC-HG	18-5162	—	—	18-5803
30③	302/303/304/305HB, 306/607HA	18-5162	—	—	—	55①	554 THRU 559HA, HC-HG	18-5162	N/A	N/A	18-5803
30②	304/305HB, 306/607HA	—	18-5241	—	N/A	70	706/707HA, HC-HF	18-5150	N/A	N/A	18-5803
35②	350/351HK, H8L, 356/357HK, H8M	—	18-5241	—	N/A	75	756/757HA	18-5150	N/A	N/A	18-5803
35③	350/351/354/355HC-HH	18-5162	—	—	18-5803	85	856/857HA, HC, HD, HE	18-5150	N/A	N/A	18-5803
35②	350/351/354/355HC-HH	18-5149	18-5169	18-5013	18-5803	90	906/907HA	18-5150	N/A	N/A	18-5803
35①	350/351/354/355HH, 356/357HF	18-5162	N/A	N/A	18-5803	105	1056/1057HA-HF, 1058HA, HB, HC	18-5150	N/A	N/A	18-5803
35③	350/351/356/357HK	18-5162	—	—	—	105	1058HD, 1059HD	N/A	N/A	N/A	18-5803
35	350/352/353/354/355HA, 352/353HF	18-5149	18-5169	18-5013	18-5803	120	1206/1207HA-HF, 1208HA, HB, HC	18-5150	N/A	N/A	18-5803
35	352/353HC-HE, HG-HJ, H2P, H8K, H9L	18-5149	18-5169	18-5013	—	120	1208HD, 1209HD	N/A	N/A	N/A	18-5803
35	353H0M, H1N	18-5149	18-5169	18-5013	—	130	1306/1307HA	18-5150	N/A	N/A	18-5803
35②	356/357HA-HF	18-5149	18-5169	18-5013	18-5803	135	1356/1357HA, 1358HA, HB, HC	18-5150	N/A	N/A	18-5803
						135	1358HD, 1359HD	N/A	N/A	N/A	18-5803
						150	1508HA	18-5150	N/A	N/A	18-5803

- ① Magnapower ignition (w/alternator & C-D Unit) ③ Standard ignition (w/alternator) ⑤ 95HA S/N 3300 & up, 95HA S/N 3125 & up
 ② Magneto ignition (no alternator) ④ 94 HA S/N 3299 & below, 95HA S/N 3124

FORCE IGNITION

Year	Model	Serial #	Contact Set	Condenser	Solenoid	Switch Box
1984-87	9.9/15	N/A	—	18-5241	—	—
1996-99	40/50	E138600-E369299	—	—	18-5834②	—
1984-87	50	N/A	18-5162	—	18-5803	—
1988	50	N/A	—	—	18-5803①	—
1991B, 1992C	70	E000001-E039023	18-5162	—	18-5803	18-5790
1991-95	70	E000001-E138599	—	—	—	18-5790
1996-99	75	E138600-UP	—	—	18-5834②	—
1991D-1992C	90	E000001-E039023	N/A	N/A	—	18-5775
1991	90 L-DRIVE	N/A	N/A	N/A	—	18-5775
1991-95	90	E000001-E138599	—	—	—	18-5790
1996-99	90	E138600-UP	—	—	18-5834②	—
1993-94	SPORT JET 90	E023150-E033710	N/A	N/A	—	18-5775
1991D-1992C& 1993, 1994	120	E000001-E093699	N/A	N/A	—	18-5881
1995	120	E093700-E138599	N/A	N/A	—	18-5881
1996-99	120	E138600-UP	—	—	18-5834②	18-5790
1991-92	120 L-DRIVE	N/A	N/A	N/A	—	18-5881

① Except "D" Models ② Style II

PREMIUM MARINE SPARK PLUG WIRE LEADS

Sierra's MAGFORCE Ignition Wires are "Electronics Friendly" protecting all of your electronic devices and electronic engine controls from RFI and EMI while delivering the maximum amount of voltage. Exact fit design ensures easy installation and years of trouble - free service.

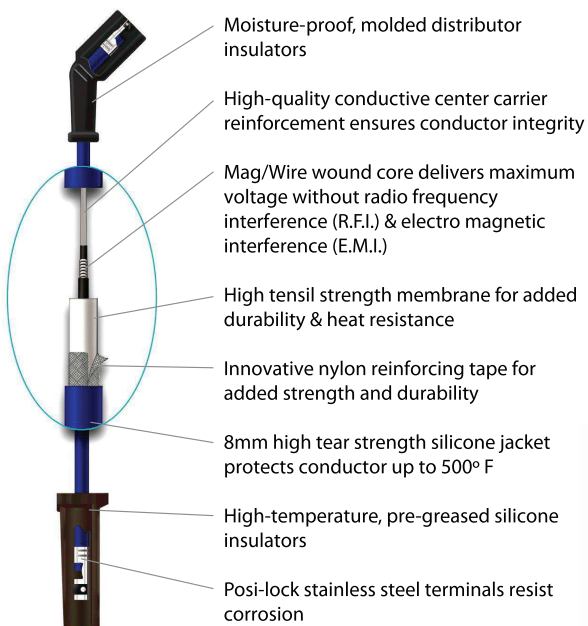

- Moisture-proof, molded distributor insulators
- High-quality conductive center carrier reinforcement ensures conductor integrity
- Mag/Wire wound core delivers maximum voltage without radio frequency interference (R.F.I.) & electro magnetic interference (E.M.I.)
- High tensile strength membrane for added durability & heat resistance
- Innovative nylon reinforcing tape for added strength and durability
- 8mm high tear strength silicone jacket protects conductor up to 500° F
- High-temperature, pre-greased silicone insulators
- Posi-lock stainless steel terminals resist corrosion



Part No.	Description
18-8819-1	7" Spark Plug Wire
18-5228-1	9" Spark Plug Wire
① 18-5228-1D	9" Spark Plug Wire
②③ 18-5229-9-1	22" Spark Plug Wire (pkg of 5)
②③ 18-5230-9-1	10" Spark Plug Wire (pkg of 5)



18-9802 TIMING LIGHT

Self-powered accurate up to 10,000 RPM's



BATTERY CABLES

Gauge cable with soldered lug terminals on each end to accept a 3/8" stud.



Part No.	Size	Color	Gauge
BC88523	2'	Red	4
BC88533	2'	Black	4
BC88543	4'	Red	2
BC88553	4'	Black	2
BC88563	6'	Red	2
BC88573	6'	Black	2
BC88583	8'	Red	1
BC88593	8'	Black	1

18-5225 SPARK PLUG WIRE KIT

Replaces:

Mercury 84-99215A26, 84-813706A26
Kit includes 25 ft. roll of 7mm hypalon ignition wire with a metallic core and a large assortment of three different end fittings to fit outboard motors.



18-5222
IGNITION WIRE
Silicone Core
(100' Spool)
8mm



18-5226
IGNITION WIRE
Metallic Core
(100' Spool)
7mm Hypalon



PKG. OF 10



18-5224
18-5224-9②
IGNITION WIRE TERMINAL

PKG. OF 10



18-5750
18-5750-9②
UNIVERSAL SPARK PLUG BOOTS
Supplied complete w/Terminal Connector

PKG. OF 10



18-5752
UNIVERSAL SPARK PLUG BOOTS
(8mm)



18-5206
CONDENSER
Replaces: 398-176

① Items ending in "D" are Display Packaged - Regular number is Non-Display
② Priced per Package
③ Uses 7mm wire copper core

MALLORY DISTRIBUTOR PARTS GUIDE

Distributor No.	Cyl. & Rotation	Description	Contact Set	Condenser	Dist. Cap	Rotor	Tune-Up Kit
ZD345A, B	8RH	Crusader	18-5314	18-5344	18-5376	18-5404-1	—
ZD347A	8LH	Crusader	18-5314	18-5344	18-5375	18-5411	—
ZD347B	8RH	Crusader	—	18-5344	18-5375	18-5411	—
YD349A	4LH	Burmeister & Wain	18-5314	18-5338	18-5355	18-5427	—
YD350A	8LH	Dearborn	18-5314	18-5338	18-5375	18-5411	18-5256 ①
YL350A	8LH	262, 272, 292, 312 Engs.	18-5314	18-5338	18-5376	18-5404-1	18-5251 ②
ZD352	8RH	Crusader	18-5314	18-5344	18-5375	18-5411	—
YD356A	8RH	Flagship Owens	18-5314	18-5338	18-5375	18-5411	18-5256 ①
YL356A	8RH	Flagship Owens	18-5314	18-5338	18-5375	18-5411	18-5256 ①
YL356A-2	8RH	Flagship	18-5314	18-5338	18-5375	18-5411	18-5256 ①
ZD358A	8LH	Crusader	18-5314	18-5344	18-5375	18-5411	—
YD359C, D, E, F	8LH	Gray (250, 327) AM Mtrs.	18-5314	18-5338	18-5376	18-5404-1	18-5251 ②
YL362A, B	8LH	Dearborn 390 Eng.	18-5314	18-5338	18-5375	18-5411	18-5256 ①
YD362A, B	8LH	Dearborn 390 Eng.	18-5314	18-5338	18-5375	18-5411	18-5256 ①
YL362C, D, E, F, G, H	8LH	390, 427 Eng.	18-5314	18-5338	18-5375	18-5411	18-5256 ①
YL362AV, BV, CV, DV	8LH	Dearborn 390 Eng.	18-5314	18-5338	18-5375	18-5411	18-5256 ①
ZD366A, B	8LH	Crusader (Cadillac 275 Eng.)	18-5314	18-5344	18-5375	18-5411	—
YD370A	4RH	Universal Mts.	18-5314	18-5338	18-5355	18-5427	—
YD370B	6RH	Universal Mts.	18-5314	18-5338	—	18-5427	—
YD370C	4RH	Universal Mts.	18-5314	18-5338	18-5355	18-5427	—
YL370A	4RH	Universal Mts.	18-5314	18-5338	18-5355	18-5427	—
YL370B	6RH	Universal Mts.	18-5314	18-5338	—	18-5427	—
YD372A, B, C, D	8LH	Chris Craft 430 Eng.	18-5314	18-5338	18-5375	18-5411	18-5256 ①
YL372C, D	8LH	Chris Craft 430 Eng.	18-5314	18-5338	18-5375	18-5411	18-5256 ①
YD372F-2	8LH	431 Eng.	18-5314	18-5338	18-5375	18-5411	18-5256 ①
YD375A	8RH	Chrysler M80	18-5314	18-5338	18-5376	18-5404-1	18-5251 ②
YD377A	6LH	Palmer	18-5314	18-5338	—	18-5427	—
YL387A	8LH	Dearborn	18-5314	18-5338	18-5376	18-5404-1	18-5251 ②
YD396A	6RH	Palmer 308 Eng.	18-5314	18-5338	—	18-5427	—
YD397A	6RH	Palmer 308 Eng.	18-5314	18-5338	—	18-5427	—
YD410A	4RH	Gray	18-5314	18-5338	18-5355	18-5427	—
YD410C	6RH	Gray	18-5314	18-5338	—	18-5427	—
YD411A	4RH	Gray	18-5314	18-5338	18-5355	18-5427	—
YD411B	4LH	Gray	18-5314	18-5338	18-5355	18-5427	—
YD411C	6RH	Gray	18-5314	18-5338	—	18-5427	—
YD411D	6LH	Gray	18-5314	18-5338	—	18-5427	—
YL411A	4RH	F-4 Turbo	18-5314	18-5338	18-5355	18-5427	—
YL411B	4LH	F-4 Turbo	18-5314	18-5338	18-5355	18-5427	—
YL411C	6RH	F-6 Turbo	18-5314	18-5338	—	18-5427	—
YL411D	6LH	F-6 Turbo	18-5314	18-5338	—	18-5427	—
YL414D, E, J, K	6RH	Dearborn	18-5314	18-5338	—	18-5427	—
YD420A, B, C, D	8RH	Palmer 345 Eng.	18-5314	18-5338	18-5375	18-5411	18-5256 ①
YL420E	8RH	IHC 304, 345, 392 Engs.	18-5314	18-5338	18-5375	18-5411	18-5256 ①
YD429A, B	8LH	Gray	18-5314	18-5338	18-5376	18-5404-1	18-5251 ②
YD429C, D	8LH	Gray	18-5314	18-5338	18-5375	18-5411	18-5256 ①
YL429C, D	8LH	138, 175 Engs.	18-5314	18-5338	18-5375	18-5411	18-5256 ①
ZD430A	8RH	170, 220, 225 HP	—	18-5338	18-5375	18-5411	—
YL431A	8RH	Crusader	18-5314	18-5338	18-5375	18-5411	18-5256 ①
ZYLD431A	8RH	185, 220, 230 HP	18-5314	18-5338	18-5375	18-5411	18-5256 ①
YL436A,B	6RH	Dorsett	18-5314	18-5338	—	18-5427	—

① 18-5272 Kit with distributor cap

② 18-5271 Kit with distributor cap

MALLORY DISTRIBUTOR PARTS GUIDE (CONT.)

Distributor No.	Cyl. & Rotation	Description	Contact Set	Condenser	Dist. Cap	Rotor	Tune-Up Kit
YL445A, B, BD, JV, KV	8LH	Dearborn	18-5314	18-5338	18-5375	18-5411	18-5256 ①
YP451A, B, C, D, E, F, G, H	6 RH	Chrysler M170 & M225 Engs.	18-5314	18-5338	—	—	—
YL455A, B,	8RH	Gray	18-5314	18-5338	18-5376	18-5404-1	18-5251 ②
YL457AC,AV, BV, CV, DV	8LH	Dearborn	18-5314	18-5338	18-5375	18-5411	18-5256 ①
YL458B	8RH	Gray	18-5314	18-5338	18-5376	18-5404-1	18-5251 ②
YL459A	8RH	Gray	18-5314	18-5338	18-5375	18-5411	18-5256 ①
YL461A, B	8RH	Crusader 409 Eng.	18-5314	18-5338	18-5376	18-5404-1	18-5251 ②
YL461A-2, B-2	8RH	427 Eng.	18-5314	18-5338	18-5376	18-5404-1	18-5251 ②
YL467A	8RH	Daytona (283, 327 Chevy Eng.)	18-5314	18-5338	18-5376	18-5404-1	18-5251 ②
YL469A	8RH	Chris-Craft (283, 327 Chevy Eng.)	18-5314	18-5338	18-5375	18-5411	18-5256 ①
YL474D, E	6RH	Dearborn (200 Ford Eng.)	18-5314	18-5338	—	18-5427	—
YL481A, B	6RH	Chevy 230, 292 Engs.	18-5314	18-5338	—	18-5427	—
YL486A,B,	6RH	Crusader (230, 292 Chevy Eng.)	18-5314	18-5338	—	18-5427	—
YL486C,D,	4 RH	Crusader 153 Eng.	18-5314	18-5338	18-5355	18-5427	—
YL487A	8RH	Crusader (283, 327 Chevy Eng.)	18-5314	18-5338	18-5376	18-5404-1	18-5251 ②
YL494A, BO	8LH	Dearborn	18-5314	18-5338	18-5376	18-5404-1	18-5251 ②
YL494A-2, B-2	8LH	427 Eng.	18-5314	18-5338	18-5376	18-5404-1	18-5251 ②
YL495A,B	6RH	Dearborn (170 Ford Eng.)	18-5314	18-5338	—	18-5427	—
YL496A, B,	8LH	Holman & Moody	18-5314	18-5338	18-5375	18-5411	18-5256 ①
YL501AV, CV, EV, GV	8LH	Oldsmobile Eng.	18-5314	18-5338	18-5375	18-5404-1	18-5251 ②
YL502A, B	8LH	Chris-Craft (427 Ford Eng.)	18-5314	18-5338	18-5375	18-5411	18-5256 ①
YL512A	8LH	289 Eng.	18-5314	18-5338	18-5376	18-5404-1	18-5251 ②
YL512CV, DV	8LH	Ford 302 Eng.	18-5314	18-5338	18-5376	18-5404-1	18-5251 ②
YL513A, B	8LH	Dearborn (289 Ford Eng.)	18-5314	18-5338	18-5376	18-5404-1	18-5251 ②
YL513CV, DV	8LH	Ford 289, 302 Engs.	18-5314	18-5338	18-5376	18-5404-1	18-5251 ②
YL514A, B, C, D	8LH	352, 390, 427, 428 Engs.	18-5314	18-5338	18-5376	18-5404-1	18-5251 ②
YL515A, B	8RH	283, 327 Engs.	18-5314	18-5338	18-5375	18-5411	18-5256 ①
YL519A, B, AV, BV	8LH	Dearborn (289 Ford Eng.)	18-5314	18-5338	18-5375	18-5411	18-5256 ①
YL520AV, BV, CV, CV2, DV, EV, JV	8RH	OMC	18-5314	18-5338	18-5375	18-5411	18-5256 ①
YL524AV, BV	6RH	300 Eng.	18-5314	18-5338	—	18-5427	—
YL529A, B	8RH	Crusader (283, 327 Engs.)	18-5314	18-5338	18-5375	18-5411	18-5256 ①
YL539AV	8RH	Chris-Craft (327 Chevy Eng.)	18-5314	18-5338	18-5375	18-5411	18-5256 ①
YL554CV, DV, EV, FV	8LH	Ford 351W Eng.	18-5314	18-5338	18-5376	18-5404-1	18-5251 ②
YL555CV, DV	8LH	Ford 351W Eng.	18-5314	18-5338	18-5376	18-5404-1	18-5251 ②
YL558AV, BV	8LH	Ford 351C Eng.	18-5314	18-5338	18-5375	18-5411	18-5256 ①
YL566AV	8RH	Chris-Craft (327 Chevy Eng.)	18-5314	18-5338	18-5375	18-5411	18-5256 ①
YL567CV, DV	8LH	Ford 351 Eng.	18-5314	18-5338	18-5376	18-5404-1	18-5251 ②
YL585AV, CV-2	8RH	Chris-Craft	18-5314	18-5338	18-5375	18-5411	18-5256 ①
YL623AV	8	Chris-Craft Thermo-Electron	18-5314	18-5338	18-5376	18-5404-1	18-5251 ②
YL623AV-2	8	Chris-Craft, Mercury	18-5314	18-5338	18-5375	18-5404-1	18-5251 ②
YL624AV	8	Gale Banks, Maritec,Mercury	18-5314	18-5338	18-5375	18-5404-1	18-5251 ②
YL624AV-2	8	Harmin	18-5314	18-5338	18-5375	18-5404-1	18-5251 ②
YL624JV	8	O.M.C.	18-5314	18-5338	18-5376	18-5404-1	18-5251 ②
YL624MV	8	Mercury (Mercruiser)	18-5314	18-5338	18-5376	18-5404-1	18-5251 ②
YL670AV	8	Chevy - Exc 348, 409 Eng.	18-5314	18-5338	18-5376	18-5404-1	18-5251 ②
YL673AV	4	Chevy 153 Eng.	18-5314	18-5338	18-5397	18-5404-1	18-5251 ②
YL676AV	6	Chevy In Line	18-5314	18-5338	—	—	18-5251 ②
YL677AV	6	Chevy Odd Fire	18-5314	18-5338	—	18-5404-1	—
YL/YS700AV	6	Chevy Even Fire	18-5314	18-5338	—	18-5404-1	18-5251 ②
YL703AV	8	Crusader/Thermo-Electron	18-5314	18-5338	18-5376	18-5404-1	18-5251 ②

① 18-5272 Kit with distributor cap

② 18-5271 Kit with distributor cap

PRESTOLITE DISTRIBUTOR PARTS GUIDE

Distributor Number	Contact Set	Condenser ③	Rotor	Cap	Ignition Coil	Tune-Up Kit
IAD-6004-2F, 2N, 2P	18-5307	18-5345	—	—	18-5435 ①	—
IAO-4109-1M	18-5307	18-5345	18-5430	18-5392	18-5435 ①	—
IAO-4113-1M	18-5307	18-5345	18-5430	18-5392	18-5435 ①	—
IAO-4114-1M	18-5307	18-5345	18-5430	18-5392	18-5435 ①	—
IAY-4010, A	18-5307	18-5345	18-5427	—	18-5435 ①	—
IAY-4014	18-5307	—	18-5427	—	18-5435 ①	—
IAY-4014C	18-5307	18-5345	18-5427	—	18-5435 ①	—
IBB-4205	18-5303 ②	—	18-5407	—	18-5435 ①	—
IBB-4301B	18-5303 ②	18-5345	18-5407	18-5369	18-5433	18-5255 ⑦
IBB-7003	18-5303 ②	18-5345	18-5407	18-5369	18-5435 ①	18-5255 ⑦
IBM-4106	18-5303	18-5345	18-5407	18-5369	—	18-5255 ⑦
IBM-4107, A	18-5303	18-5345	18-5407	18-5369	18-5435 ①	18-5255 ⑦
IBM-4108, A, B, C	18-5303	18-5345	18-5407	18-5369	—	18-5255 ⑦
IBM-4109, A	18-5303	18-5345	18-5407	18-5369	—	18-5255 ⑦
IBM-4110	18-5303	18-5345	18-5429	18-5391	—	18-5259
IBM-4112	18-5303	18-5345	18-5429	18-5391	18-5435 ①	18-5259
IBM-4115	18-5303	18-5345	18-5429	18-5391	18-5435	18-5258
IBM-4116	18-5303	18-5345	18-5429	18-5391	18-5435	18-5258
IBM-4117A	18-5303	18-5345	18-5407	18-5369	18-5435 ①	18-5255 ⑦
IBM-4118A	18-5303	18-5345	18-5429	18-5391	18-5435 ①	18-5259
IBM-4119, A	18-5303	18-5345	18-5429	18-5391	18-5435 ①	18-5259
IBM-4120	18-5303	18-5347	18-5429	18-5391	18-5433	18-5259
IBM-4122	18-5303	18-5347	18-5407	18-5369	18-5435 ①	18-5258 ⑦
IBM-7003B, BS	18-5303	18-5345	18-5407	18-5369	18-5433	18-5255 ⑦
IBM-7004A, AS, B, BS	18-5303	18-5345	18-5407	18-5369	18-5435 ①	18-5255 ⑦
IBM-7007, A, AS, S	18-5303	18-5345	18-5407	18-5369	18-5435 ①	18-5255 ⑦
IBM-7008, A, AS, B, BS, C, CS, S	18-5303	18-5345	18-5407	18-5369	18-5435 ①	18-5255 ⑦
IBM-7010	—	18-5345	18-5407	18-5369	18-5433	—
IBM-7011	18-5303	18-5345	18-5407	18-5369	18-5433	18-5255 ⑦
IBM-7011A	18-5303	18-5345	18-5407	18-5369	18-5435 ①	18-5255 ⑦
IBM-7011B	—	18-5345	18-5407	18-5369	18-5435 ①	—
IBM-7011C, D	18-5303	18-5345	18-5407	18-5369	18-5435 ①	18-5255 ⑦
IBM-7013	18-5303	18-5345	18-5403	18-5352	—	18-5260 ④
IBM-7013A	18-5303	18-5345	18-5403	18-5352	18-5433	18-5260 ④
IBM-7013B	—	18-5345	18-5403	18-5352	—	—
IBM-7013C, D, E	18-5303	18-5345	18-5403	18-5352	—	18-5260 ④
IBM-7014	18-5303	18-5345	18-5403	18-5353	—	18-5260 ⑥
IBM-7014A	18-5303	18-5347	18-5403	18-5353	18-5433	18-5258 ⑥
IBM-7016	18-5303	18-5345	18-5409	18-5352	—	18-5260 ④
IBM-7017	18-5303	18-5345	18-5409	18-5352	—	18-5260 ④
IBM-7018	18-5303	18-5345	18-5409	18-5353	—	18-5260 ⑥
IBM-7019, A, AS, S	18-5303	18-5345	18-5403	18-5352	18-5435 ①	18-5260 ④
IBM-7020, A, AS, B, BS, C, CS, S	18-5303	18-5345	18-5403	18-5352	18-5435 ①	18-5260 ④
IBM-7021	18-5303	18-5345	18-5403	18-5353	—	18-5260
IBP-4105, A	—	18-5345	18-5407	18-5369	18-5435 ①	—
IBP-4110, A, B	—	18-5345	18-5429	18-5391	18-5435 ①	—
IBP-4111A	—	18-5345	18-5407	18-5369	18-5435 ①	—
IBP-4112A, B	—	18-5345	18-5429	18-5391	18-5435 ①	—
IBP-4113A, B, C	—	18-5345	18-5429	18-5391	18-5435 ①	—
IBR-4205, A, S	—	18-5347	—	—	18-5435 ①	—
IBR-7002, A, AS, S	18-5307	18-5345	18-5430	18-5392	18-5433	—
IDD-7001	N/A	N/A	18-5407	18-5369	—	N/A
IDH-7001, S	N/A	N/A	18-5407	18-5369	—	N/A
IDH-7002, S	N/A	N/A	18-5407	18-5369	—	N/A
IDH-7003A, AS, S	N/A	N/A	18-5407	18-5369	—	N/A
IDH-7004	N/A	N/A	18-5409	18-5352	—	N/A
IDH-7005	N/A	N/A	18-5409	18-5352	—	N/A
IDH-7006, A	N/A	N/A	18-5403	18-5352	—	N/A
IDH-7802	N/A	N/A	18-5403	—	18-5433	N/A
IDU-7601	N/A	N/A	18-5403	18-5353	—	N/A
IDU-7801, A, B	N/A	N/A	18-5403	18-5352	18-5433	N/A
IGC-5501A	18-5307	18-5345	18-5430	—	18-5435 ①	—
IGW-4056	—	—	—	—	18-5433	—
IGW-4118A	—	—	—	—	18-5435 ①	—
IGW-4199B, C	—	—	—	—	18-5435 ①	—
IGW-4301	—	—	—	—	18-5435 ①	—
IGW-4409A	—	—	—	—	18-5435 ①	—

N/A Not Applicable ① 12 Volt System Only ② 2 Required ③ Condensers 18-5340 (Wire Conductor) and 18-5347 (Strap Conductor) are interchangeable.

④ 18-5275 Kit with distributor cap

⑤ 18-5276 Kit with distributor cap

⑦ 18-5277 Kit with distributor cap