

Giranti: Neoprene, Nitrile e loro utilizzo

Impellers: Neoprene, Nitrile and their use

Le giranti sono un componente importante della pompa di raffreddamento motore. Esse vanno tenute controllate e vanno cambiate una volta all'anno o almeno ogni 500 ore di funzionamento del motore. Vengono prodotte normalmente in gomma Neoprene che ha buone caratteristiche meccaniche e conferisce alla pompa una buona portata di acqua. Cio' rende le giranti in Neoprene piu' adatte al raffreddamento dei motori. Se le giranti venissero utilizzate in pompe di sentina e quindi a contatto con tracce di oli o carburanti si preferisce usare la gomma Nitrilica che, pur diminuendo la portata della pompa su cui vengono montate a causa delle scarse proprietà meccaniche di questo polimero, evita il rigonfiamento delle palette e quindi elimina la possibilità di bloccaggio della pompa.

The impellers are important components of the cooling system in the engine. They need to be checked and changed once a year or, at least, every 500 hours. They are usually made in the neoprene rubber which has good mechanical properties and gives the pump a good delivery. This means that the neoprene impellers' use is more adequate in the cooling pumps. If the impellers have to be used in a bilge pump having contact with oil and fuels, we suggest to use Nitrile rubber impellers that have less mechanical properties but better chemical resistance to these substance avoiding the swelling of the blade and eliminating the possibility of blocking the pump.

Inserti Drives

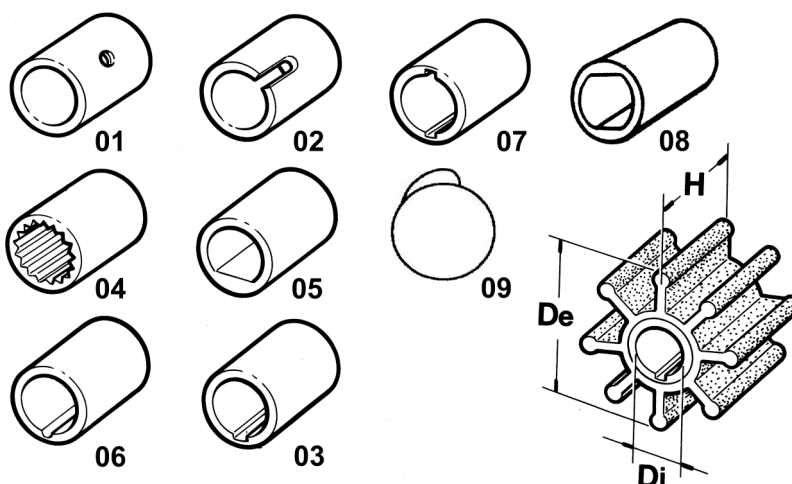

Estrattore per la sostituzione

Impeller puller

Codice Code: **1834** estrattore grande *big puller*
1835 estrattore piccolo *little puller*

Quando sostituite la girante suggeriamo di utilizzare l'apposito lubrificante che accludiamo nella confezione.

In case of substitution of the impeller we suggest to use the appropriate lubricant enclosed.



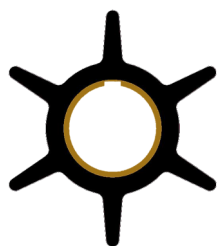

Codice Code	Ext. Diam.	Int. Diam.	Altezza Depth	Ins.	Pale Blades	Material
5378	31,8	11,6	14,4	6	6	Neoprene



Codice Code	Ext. Diam.	Int. Diam.	Altezza Depth	Ins.	Pale Blades	Material
2044	32	8,1	12	5	6	Neoprene
3852	32	8,1	12	5	6	Nitrile
536	32	8,1	13	5	6	Nitrile



Codice Code	Ext. Diam.	Int. Diam.	Altezza Depth	Ins.	Pale Blades	Material
2055	32.00	12.00	13.30	6	6	Neoprene
2057	32.00	11.60	14.40	6	6	Neoprene
2061	32.00	11.15	14.35	6	6	Neoprene
2555	32.00	11.60	14.40	2	6	Neoprene
3378	32.00	10.10	14.40	6	6	Neoprene

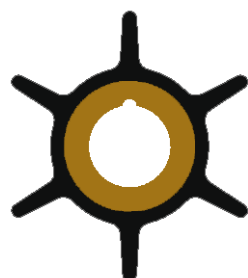

Codice Code	Ext. Diam.	Int. Diam.	Altezza Depth	Ins.	Pale Blades	Material
6048	33.60	10.35	14.40	6	6	Neoprene

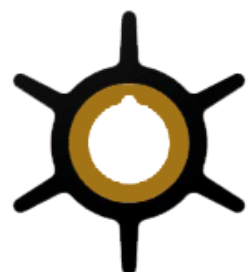

Codice Code	Ext. Diam.	Int. Diam.	Altezza Depth	Ins.	Pale Blades	Material
5377	33.70	10,4	14.10	6	6	Neoprene



Codice Code	Ext. Diam.	Int. Diam.	Altezza Depth	Ins.	Pale Blades	Material
4030	35.00	12.00	15.00	3	6	Neoprene

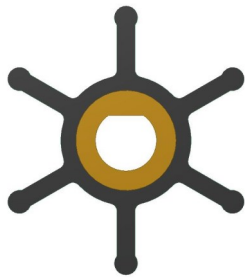

Codice Code	Ext. Diam.	Int. Diam.	Altezza Depth	Ins.	Pale Blades	Material
5411	35.20	8.00	12.70	5	6	Nitrile

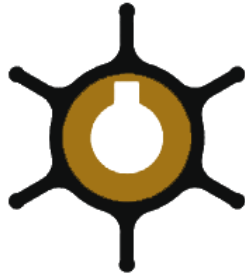

Codice Code	Ext. Diam.	Int. Diam.	Altezza Depth	Ins.	Pale Blades	Material
5356	36.00	9.70	14.50	3	6	Neoprene

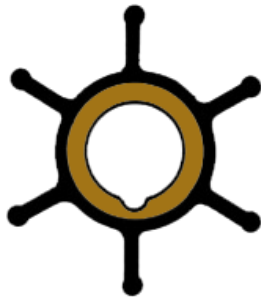

Codice Code	Ext. Diam.	Int. Diam.	Altezza Depth	Ins.	Pale Blades	Material
2072	38.40	11.10	17.90	6	6	Neoprene
2073	38.40	12.80	17.80	6	6	Neoprene

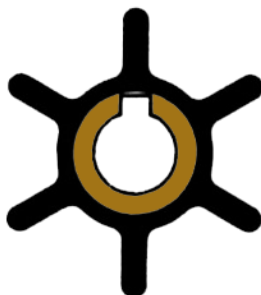

Codice Code	Ext. Diam.	Int. Diam.	Altezza Depth	Ins.	Pale Blades	Material
3375	38.40	11.20	17.90	3	6	Neoprene



Codice Code	Ext. Diam.	Int. Diam.	Altezza Depth	Ins.	Pale Blades	Material
5369	39.00	13.20	21.90	3	6	Neoprene

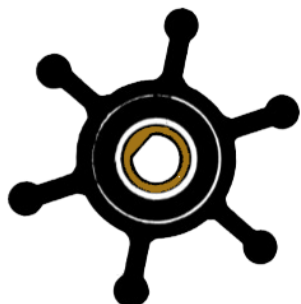

Codice Code	Ext. Diam.	Int. Diam.	Altezza Depth	Ins.	Pale Blades	Material
1872	40.00	8.10	19.00	5	6	Neoprene



Codice Code	Ext. Diam.	Int. Diam.	Altezza Depth	Ins.	Pale Blades	Material
2043	40.00	9.60	19.00	1	6	Neoprene
2048	40.00	12.00	19.00	1	6	Neoprene
3268	40.00	10.00	19.00	1	6	Neoprene
3404	40.00	10.00	19.00	1	6	Nitrile

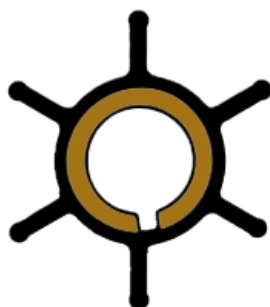

Codice Code	Ext. Diam.	Int. Diam.	Altezza Depth	Ins.	Pale Blades	Material
2063	40.00	13.10	22.00	3	6	Neoprene
2064	40.00	14.20	22.00	3	6	Neoprene
3630	40.00	11.80	18.00	3	6	Neoprene

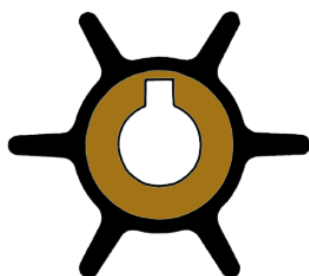

Codice Code	Ext. Diam.	Int. Diam.	Altezza Depth	Ins.	Pale Blades	Material
3791	40.00	11.00	13.00	3	6	Neoprene

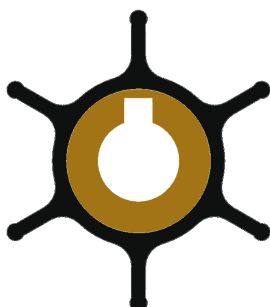

Codice Code	Ext. Diam.	Int. Diam.	Altezza Depth	Ins.	Pale Blades	Material
5357	40.00	10.80	12.60	3	6	Neoprene

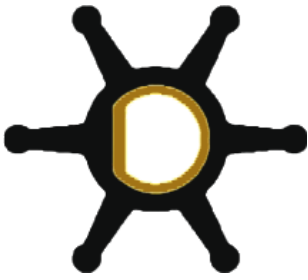

Codice Code	Ext. Diam.	Int. Diam.	Altezza Depth	Ins.	Pale Blades	Material
4807	40.00	12.10	19.00	5	6	Neoprene



Codice Code	Ext. Diam.	Int. Diam.	Altezza Depth	Ins.	Pale Blades	Material
5272	40.00	10.00	14.00	7	6	Neoprene

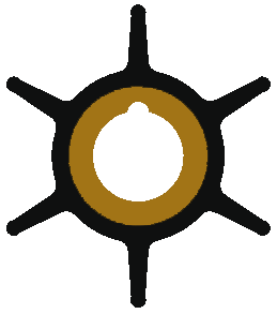

Codice Code	Ext. Diam.	Int. Diam.	Altezza Depth	Ins.	Pale Blades	Material
6049	40.00	12.10	18.00	6	6	Neoprene



Codice Code	Ext. Diam.	Int. Diam.	Altezza Depth	Ins.	Pale Blades	Material
5569	40.40	14.00	28.40	3	6	Neoprene

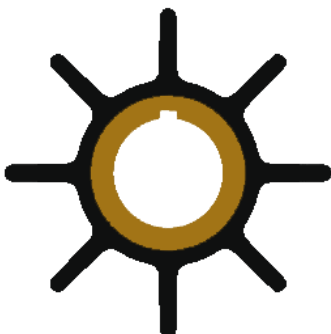

Codice Code	Ext. Diam.	Int. Diam.	Altezza Depth	Ins.	Pale Blades	Material
6050	40.70	13.96	23.35	3	8	Neoprene

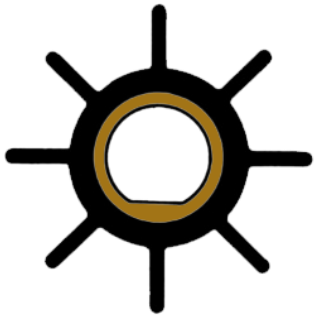

Codice Code	Ext. Diam.	Int. Diam.	Altezza Depth	Ins.	Pale Blades	Material
2067	41.00	14.00	23.00	5	8	Neoprene

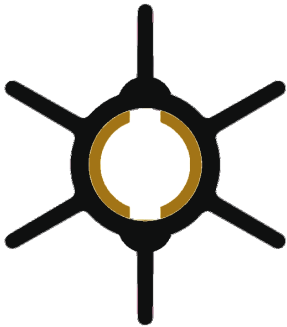

Codice Code	Ext. Diam.	Int. Diam.	Altezza Depth	Ins.	Pale Blades	Material
5376	43.00	12.00	14.00	3	6	Neoprene

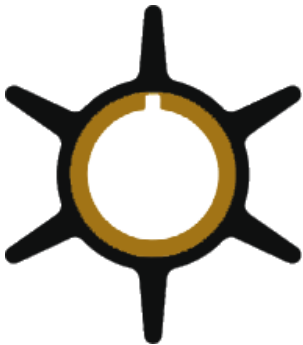

Codice Code	Ext. Diam.	Int. Diam.	Altezza Depth	Ins.	Pale Blades	Material
5379	44.00	17.20	20.00	3	6	Neoprene

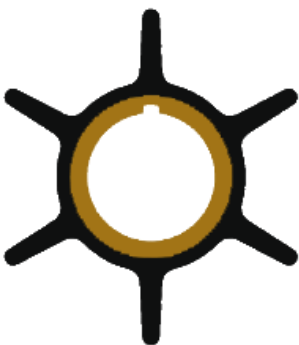

Codice Code	Ext. Diam.	Int. Diam.	Altezza Depth	Ins.	Pale Blades	Material
6051	44.10	17.12	20.25	3	6	Neoprene



Codice Code	Ext. Diam.	Int. Diam.	Altezza Depth	Ins.	Pale Blades	Material
2079	45.00	8.10	12.80	5	6	Nitrile

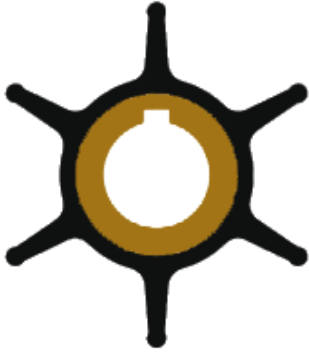

Codice Code	Ext. Diam.	Int. Diam.	Altezza Depth	Ins.	Pale Blades	Material
5572	45.40	13.20	14.70	3	6	Neoprene



Codice Code	Ext. Diam.	Int. Diam.	Altezza Depth	Ins.	Pale Blades	Material
5573	45.40	16.20	14.70	3	6	Neoprene

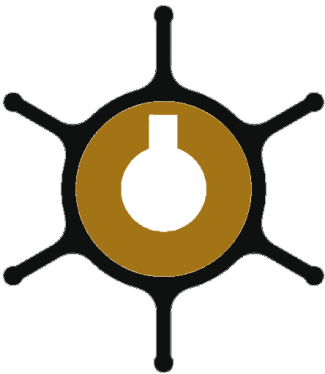

Codice Code	Ext. Diam.	Int. Diam.	Altezza Depth	Ins.	Pale Blades	Material
5355	48.00	11.00	13.80	3	6	Neoprene

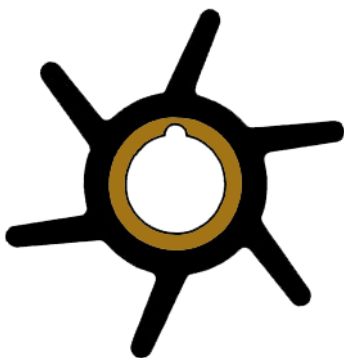

Codice Code	Ext. Diam.	Int. Diam.	Altezza Depth	Ins.	Pale Blades	Material
3793	48.00	13.00	15.00	6	6	Neoprene

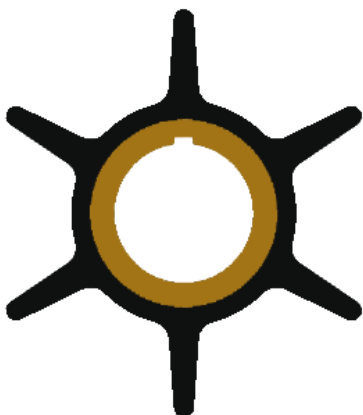

Codice Code	Ext. Diam.	Int. Diam.	Altezza Depth	Ins.	Pale Blades	Material
6052	50.40	17.20	20.15	3	6	Neoprene

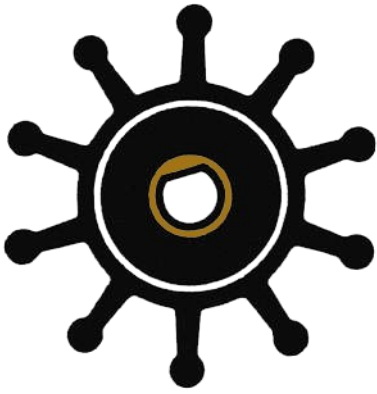

Codice Code	Ext. Diam.	Int. Diam.	Altezza Depth	Ins.	Pale Blades	Material
568	51.00	8.10	22.00	5	10	Nitrile



Codice Code	Ext. Diam.	Int. Diam.	Altezza Depth	Ins.	Pale Blades	Material	Pin
2046	51.00	12.70	22.00	1	6	Neoprene	5 mm
2522	51.00	12.00	22.00	1	6	Neoprene	5 mm
3269	51.00	12.70	22.00	1	6	Nitrile	5 mm
3411	51.00	12.00	22.00	1	6	Nitrile	5 mm
5053	51.00	12.00	22.00	1	6	Neoprene	4 mm

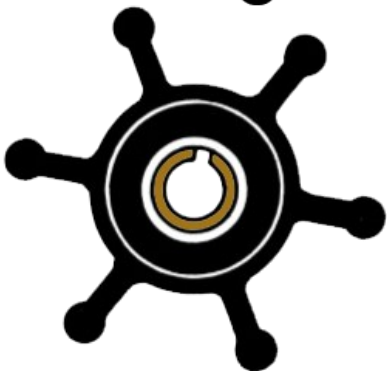

Codice Code	Ext. Diam.	Int. Diam.	Altezza Depth	Ins.	Pale Blades	Material
2049	51.00	10.00	22.00	3	6	Neoprene
2051	51.00	13.00	22.00	3	6	Neoprene
5435	51.00	12.70	20.00	3	6	Neoprene
5550	51.00	12.70	22.00	3	6	Neoprene

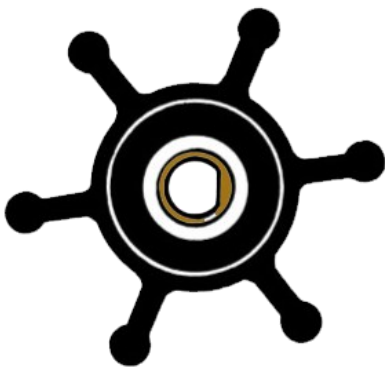

Codice Code	Ext. Diam.	Int. Diam.	Altezza Depth	Ins.	Pale Blades	Material
2052	51.00	12.70	22.00	5	6	Neoprene
2080	51.00	8.10	22.00	5	6	Nitrile
2745	51.00	8.10	22.00	5	6	Neoprene



Codice Code	Ext. Diam.	Int. Diam.	Altezza Depth	Ins.	Pale Blades	Material
2056	51.00	17.00	19.10	6	6	Neoprene
2058	51.00	16.00	19.10	6	6	Neoprene

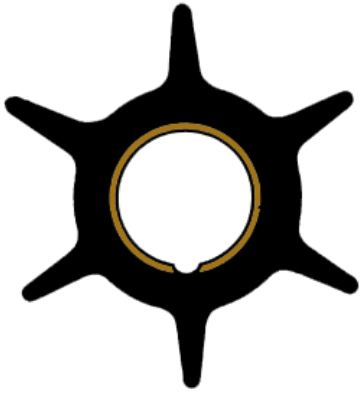

Codice Code	Ext. Diam.	Int. Diam.	Altezza Depth	Ins.	Pale Blades	Material
2059	51.00	19.10	19.00	6	6	Neoprene



Codice Code	Ext. Diam.	Int. Diam.	Altezza Depth	Ins.	Pale Blades	Material
2074	51.00	16.00	19.10		6	Neoprene

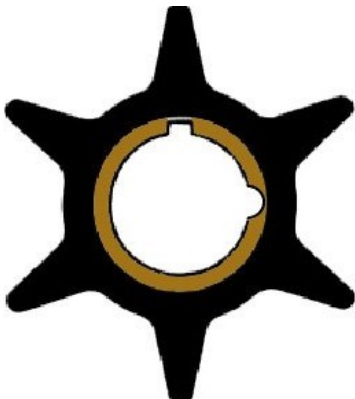

Codice Code	Ext. Diam.	Int. Diam.	Altezza Depth	Ins.	Pale Blades	Material
3374	51.00	19,2	18.85	6	6	Neoprene

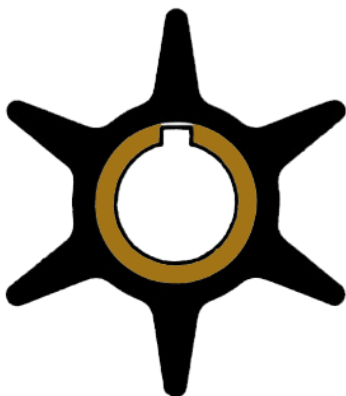

Codice Code	Ext. Diam.	Int. Diam.	Altezza Depth	Ins.	Pale Blades	Material
3376	51.00	14.00	19.00	3	6	Neoprene

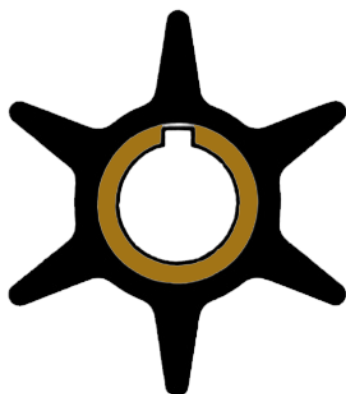

Codice Code	Ext. Diam.	Int. Diam.	Altezza Depth	Ins.	Pale Blades	Material
3377	51.00	16.00	19.00	3	6	Neoprene

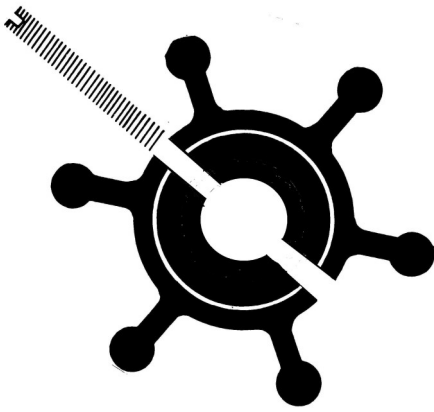

Codice Code	Ext. Diam.	Int. Diam.	Altezza Depth	Ins.	Pale Blades	Material
3398	51.00	8.00	22.00	1	6	Neoprene
3399	51.00	8.00	22.00	1	6	Nitrile
5192	52.00	12	25.00	1	6	Neoprene

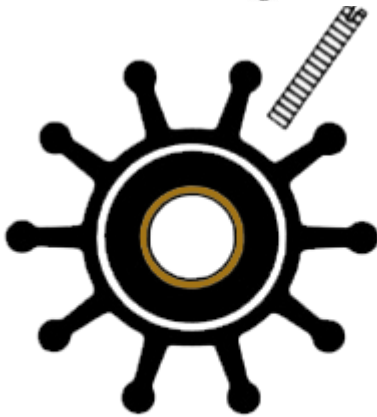

Codice Code	Ext. Diam.	Int. Diam.	Altezza Depth	Ins.	Pale Blades	Material
3823	51.00	12.10	22.00	1	10	Neoprene
3830	51.00	12.70	22.00	1	10	Neoprene

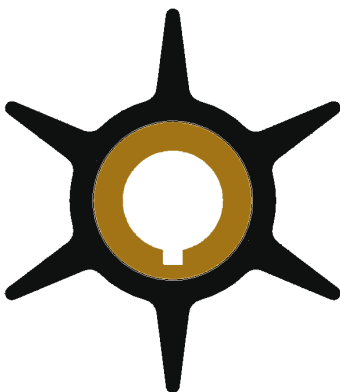

Codice Code	Ext. Diam.	Int. Diam.	Altezza Depth	Ins.	Pale Blades	Material
5361	51.60	13.90	18.70	3	6	Neoprene
5363	51.60	18.20	18.80	3	6	Neoprene
5362	51.80	16.20	18.80	3	6	Neoprene

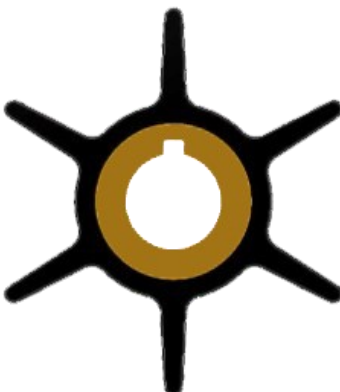

Codice Code	Ext. Diam.	Int. Diam.	Altezza Depth	Ins.	Pale Blades	Material
5359	52.80	12.95	14.00	3	6	Neoprene
6829	53.00	12.00	14.00	3	6	Neoprene

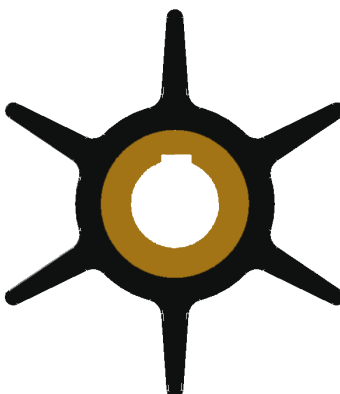

Codice Code	Ext. Diam.	Int. Diam.	Altezza Depth	Ins.	Pale Blades	Material
5367	52.80	12.00	13.85	3	6	Neoprene

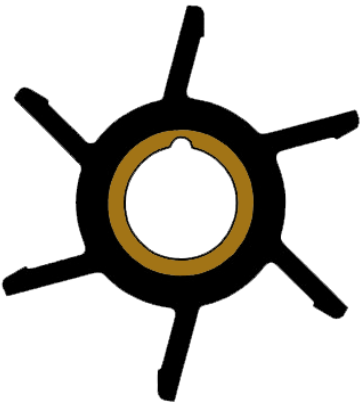

Codice Code	Ext. Diam.	Int. Diam.	Altezza Depth	Ins.	Pale Blades	Material
3792	53.00	15.00	20.00	6	6	Neoprene



Codice Code	Ext. Diam.	Int. Diam.	Altezza Depth	Ins.	Pale Blades	Material
5570	55.20	17.20	20.00	3	6	Neoprene
5571	55.20	17.20	20.00	3	6	Neoprene

5570 largh. Chiavetta 5 mm

5571 largh. Chiavetta 4 mm

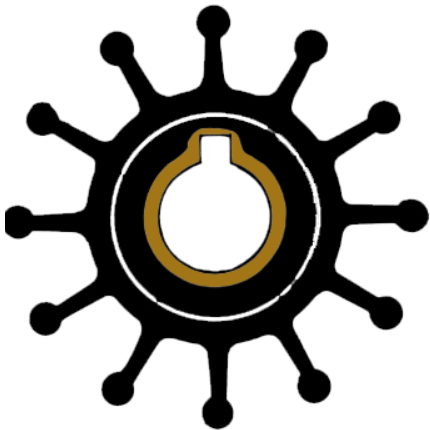

Codice Code	Ext. Diam.	Int. Diam.	Altezza Depth	Ins.	Pale Blades	Material
2081	56.00	12.10	29.40	3	12	Nitrile
3342	56.00	12.10	29.40	3	12	Neoprene
2041	57.00	16.00	31.50	3	12	Neoprene
7307	57.00	16.00	31.50	3	12	Neo+Key
3403	57.00	16.00	31.50	3	12	Nitrile
3414	57.00	20.00	31.50	3	12	Nitrile

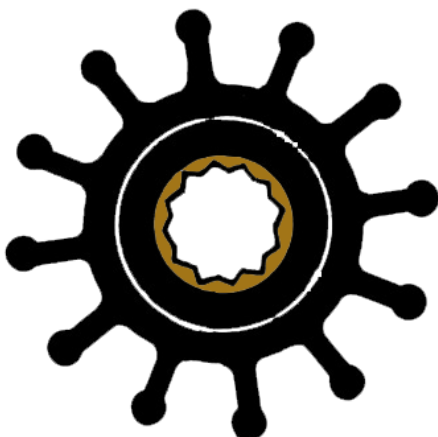

Codice Code	Ext. Diam.	Int. Diam.	Altezza Depth	Ins.	Pale Blades	Material
2040	57.00	16.00	31.50	4	12	Neoprene
2078	57.00	16.00	31.50	4	12	Nitrile
2789	57.00	16.00	50.80	4	12	Neoprene
3267	57.00	16.00	48.20	4	12	Neoprene
5734	57.00	16.00	50.10	4	12	Neoprene

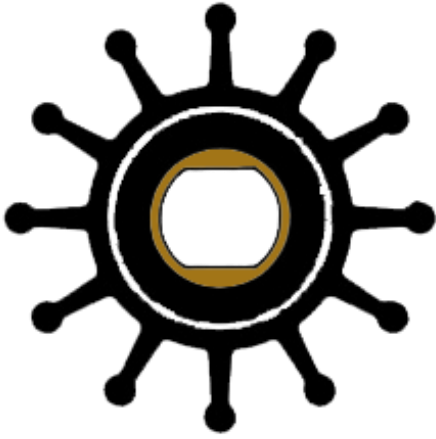

Codice Code	Ext. Diam.	Int. Diam.	Altezza Depth	Ins.	Pale Blades	Material
3392	57.00	16.00	31.50	8	12	Neoprene

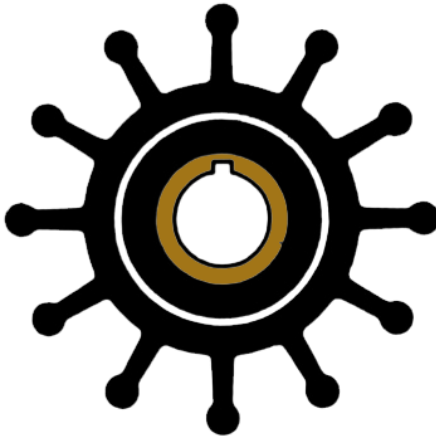

Codice Code	Ext. Diam.	Int. Diam.	Altezza Depth	Ins.	Pale Blades	Material
3950	57.00	12.70	19.80	3	12	Neoprene

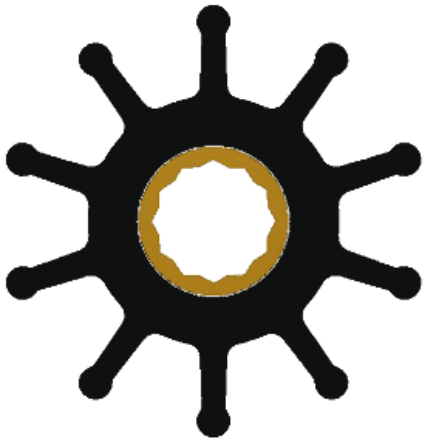

Codice Code	Ext. Diam.	Int. Diam.	Altezza Depth	Ins.	Pale Blades	Material
6184	57.00	16.00	50.80	4	10	Neoprene



Codice Code	Ext. Diam.	Int. Diam.	Altezza Depth	Ins.	Pale Blades	Material
6670	57.00	16.00	50.80	8	10	Neoprene

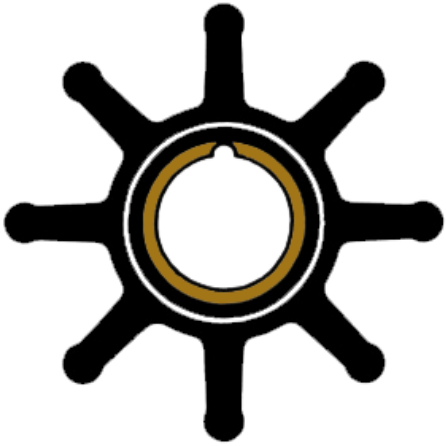

Codice Code	Ext. Diam.	Int. Diam.	Altezza Depth	Ins.	Pale Blades	Material
3265	57.70	18.10	22.60	6	6	Neoprene

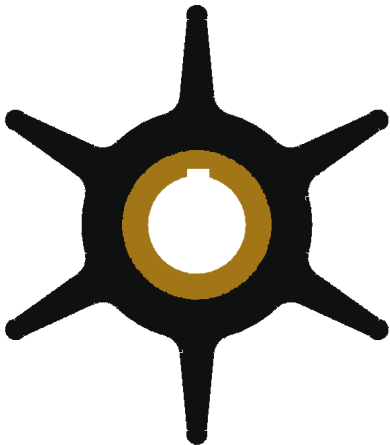

Codice Code	Ext. Diam.	Int. Diam.	Altezza Depth	Ins.	Pale Blades	Material
5364	58.00	20.00	29.50	3	6	Neoprene

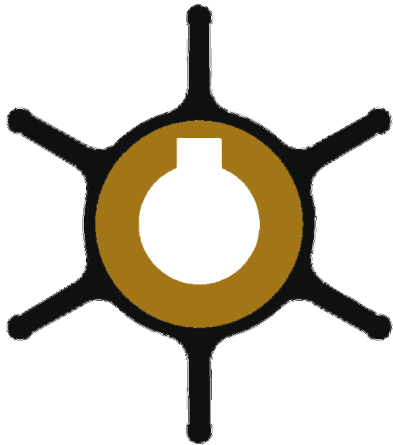

Codice Code	Ext. Diam.	Int. Diam.	Altezza Depth	Ins.	Pale Blades	Material
5366	58.00	20.00	34.00	3	6	Neoprene

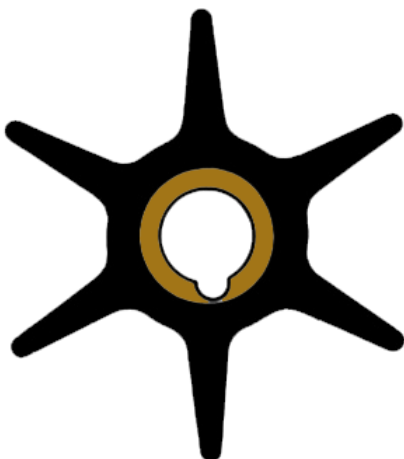

Codice Code	Ext. Diam.	Int. Diam.	Altezza Depth	Ins.	Pale Blades	Material
2062	59.50	12.70	12.00	6	6	Neoprene

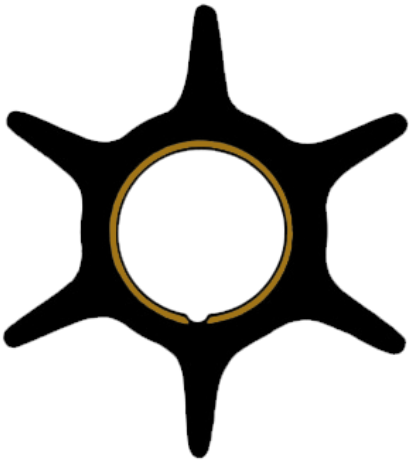

Codice Code	Ext. Diam.	Int. Diam.	Altezza Depth	Ins.	Pale Blades	Material
2060	60.00	22.30	33.65	6	6	Neoprene

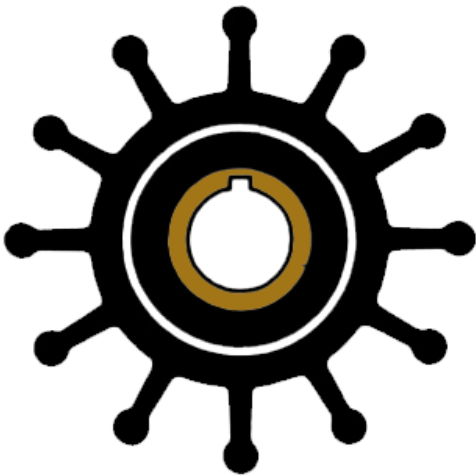

Codice Code	Ext. Diam.	Int. Diam.	Altezza Depth	Ins.	Pale Blades	Material
2037	61.90	16.00	31.50	3	12	Neoprene

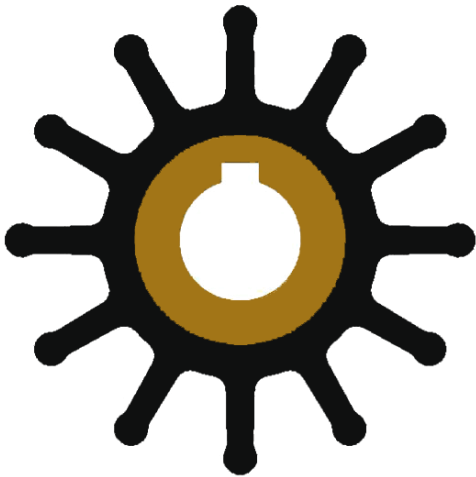

Codice Code	Ext. Diam.	Int. Diam.	Altezza Depth	Ins.	Pale Blades	Material
4988	62.20	16.00	22.20	3	12	Neoprene

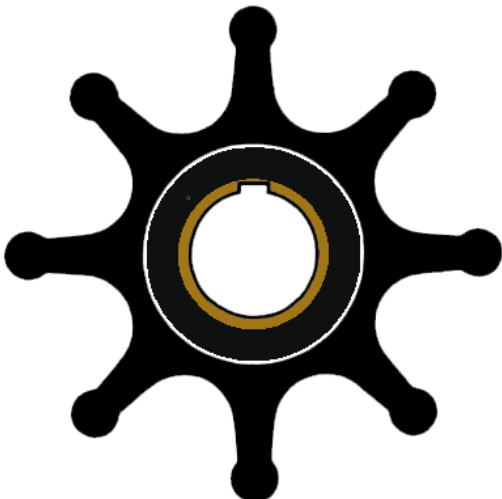

Codice Code	Ext. Diam.	Int. Diam.	Altezza Depth	Ins.	Pale Blades	Material
2036	65.00	16.00	50.80	3	8	Neoprene
3407	65.00	16.00	50.80	3	8	Nitrile
3379	65.40	17.00	48.40	3	8	Neoprene
2050	66.00	17.00	32.00	3	8	Neoprene
3410	66.00	17.00	32.00	3	8	Nitrile

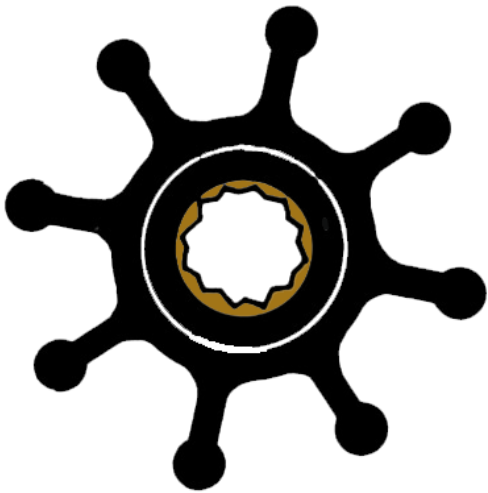

Codice Code	Ext. Diam.	Int. Diam.	Altezza Depth	Ins.	Pale Blades	Material
2039	65.00	16.00	50.80	4	8	Neoprene
2077	65.00	16.00	50.20	4	8	Nitrile
3260	65.00	16.00	76.20	4	8	Neoprene
3388	65.00	16.00	32.00	4	8	Neoprene
3408	65.00	16.00	36.50	4	8	Neoprene
3509	65.00	16.00	68.30	4	8	Neoprene

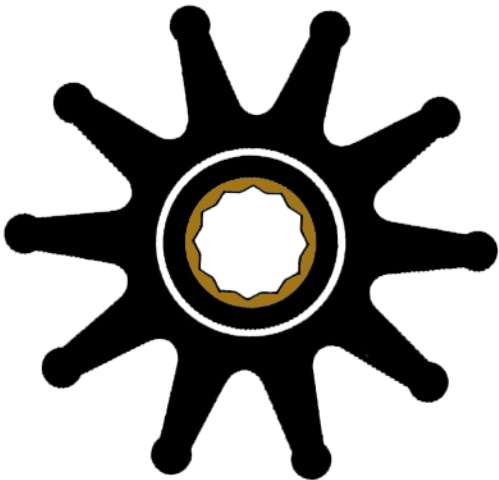

Codice Code	Ext. Diam.	Int. Diam.	Altezza Depth	Ins.	Pale Blades	Material
2042	65.00	16.00	50.20	4	10	Neoprene
3405	65.00	16.00	50.20	4	10	Nitrile
6877	65.00	16.00	68.00	4	10	Neoprene

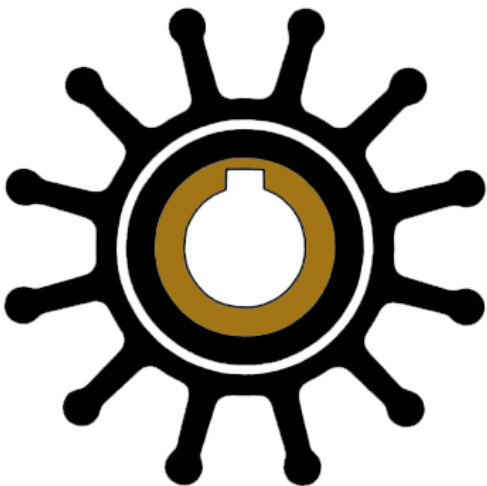

Codice Code	Ext. Diam.	Int. Diam.	Altezza Depth	Ins.	Pale Blades	Material
2047	65.00	16.00	41.40	3	12	Neoprene
3790	65.00	16.00	50.80	3	12	Neoprene

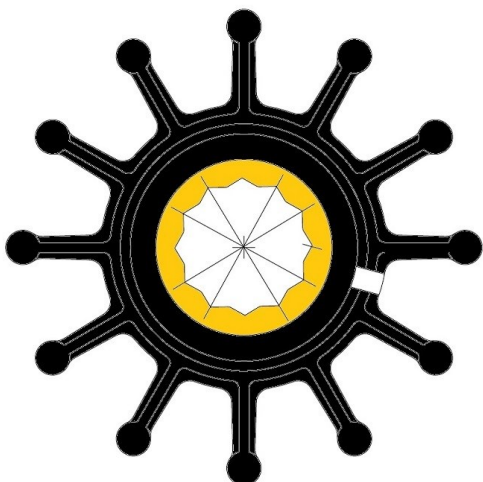

Codice Code	Ext. Diam.	Int. Diam.	Altezza Depth	Ins.	Pale Blades	Material
4821	65.00	16.00	41.40	4	12	Neoprene

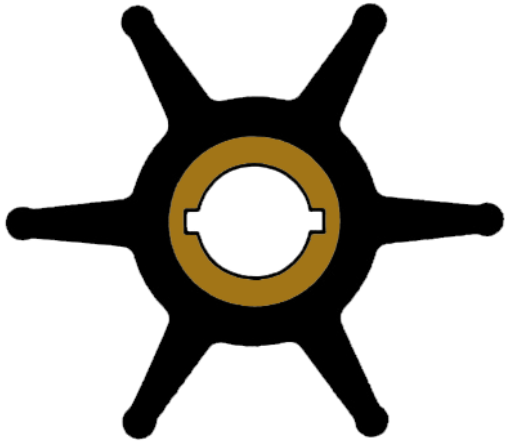

Codice Code	Ext. Diam.	Int. Diam.	Altezza Depth	Ins.	Pale Blades	Material
3500	65.00	15.00	15.00	7	6	Neoprene

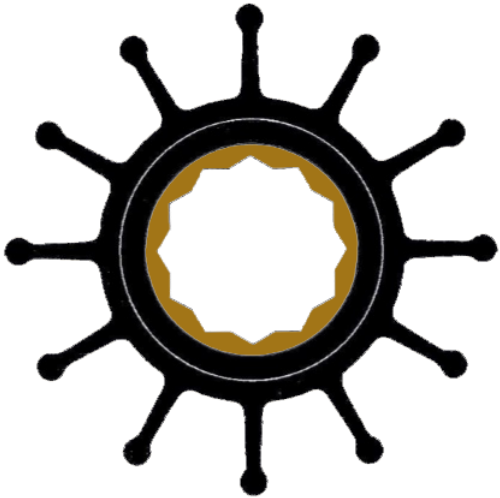

Codice Code	Ext. Diam.	Int. Diam.	Altezza Depth	Ins.	Pale Blades	Material
4205	65.00	25.00	80.00	4	12	Neoprene

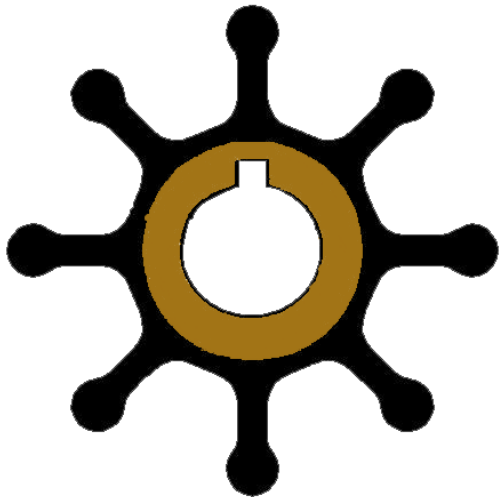

Codice Code	Ext. Diam.	Int. Diam.	Altezza Depth	Ins.	Pale Blades	Material
4813	65.00	16.00	50.80	2	8	Neoprene

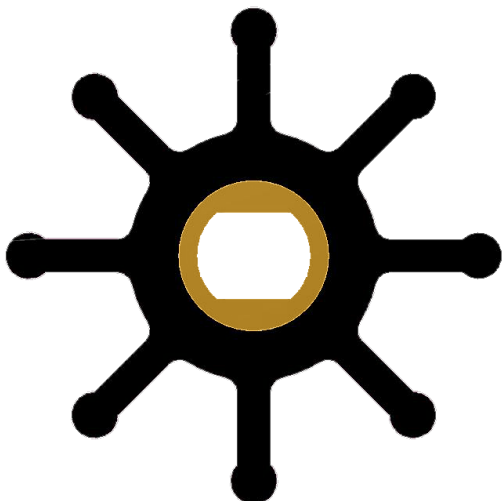

Codice Code	Ext. Diam.	Int. Diam.	Altezza Depth	Ins.	Pale Blades	Material
5382	65.00	15.00	50.80	8	8	Neoprene

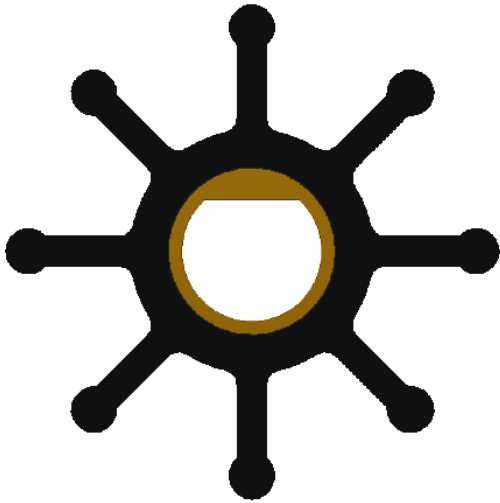

Codice Code	Ext. Diam.	Int. Diam.	Altezza Depth	Ins.	Pale Blades	Material
3386	66.00	19.00	50.50	5	8	Neoprene

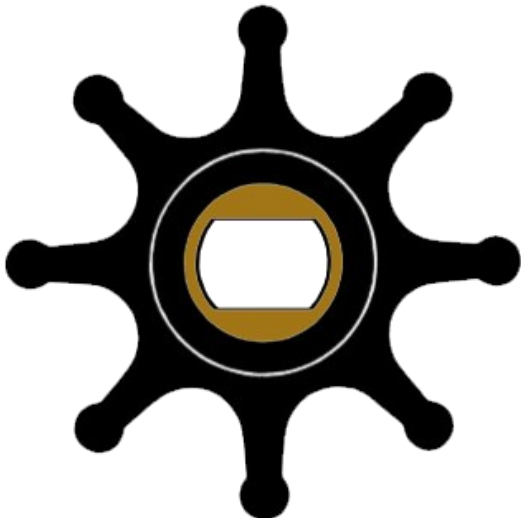

Codice Code	Ext. Diam.	Int. Diam.	Altezza Depth	Ins.	Pale Blades	Material
5640	65.00	16.00	50.20	8	8	Neoprene

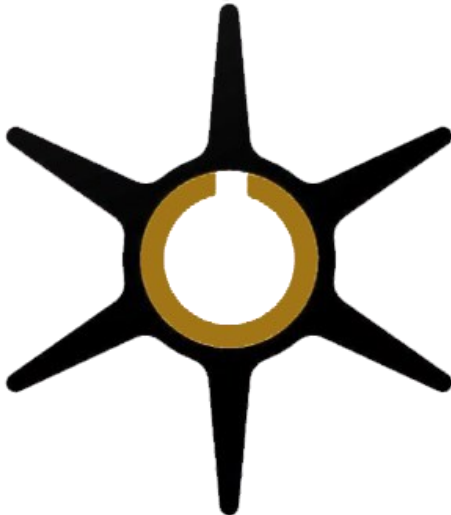

Codice Code	Ext. Diam.	Int. Diam.	Altezza Depth	Ins.	Pale Blades	Material
5370	66.80	17.00	16.00	3	6	Neoprene
5371	66.80	17.00	19.00	3	6	Neoprene
5372	66.80	20.00	19.15	3	6	Neoprene

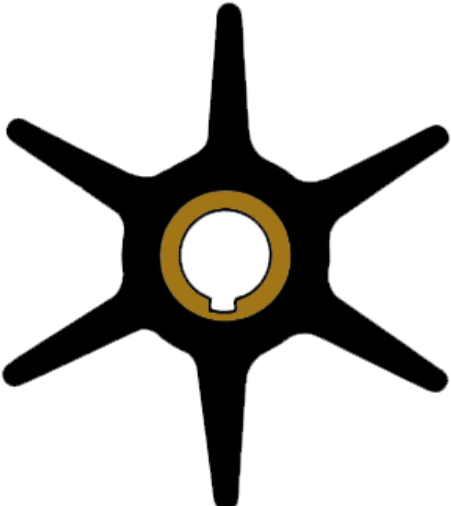

Codice Code	Ext. Diam.	Int. Diam.	Altezza Depth	Ins.	Pale Blades	Material
3666	67.00	19.80	19.20	3	6	Neoprene
3667	67.00	17.00	19.20	3	6	Neoprene
3668	67.00	17.00	16.00	3	6	Neoprene
2068	69.50	11.00	12.95	3	6	Neoprene
2069	69.50	12.75	12.80	3	6	Neoprene

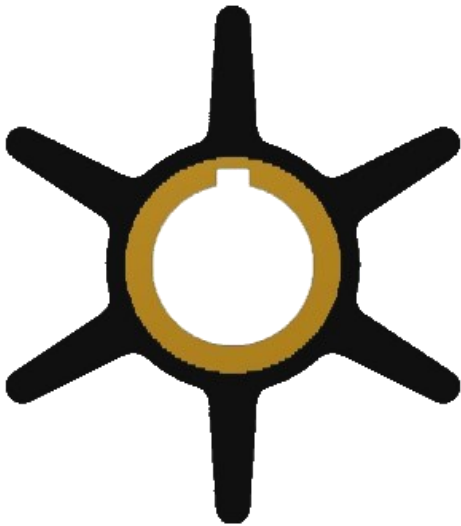

Codice Code	Ext. Diam.	Int. Diam.	Altezza Depth	Ins.	Pale Blades	Material
6053	67.40	20.15	35.10	3	6	Neoprene

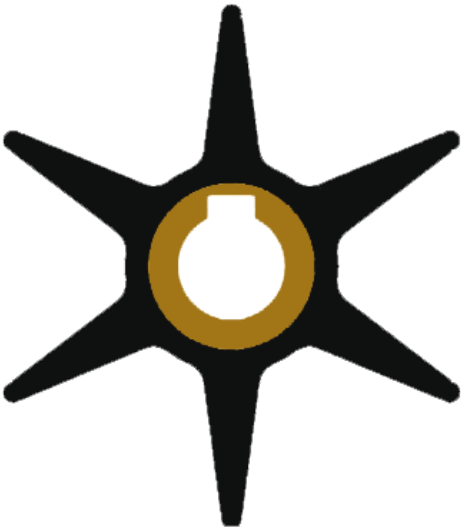

Codice Code	Ext. Diam.	Int. Diam.	Altezza Depth	Ins.	Pale Blades	Material
5360	69.00	14.00	13.00	3	6	Neoprene

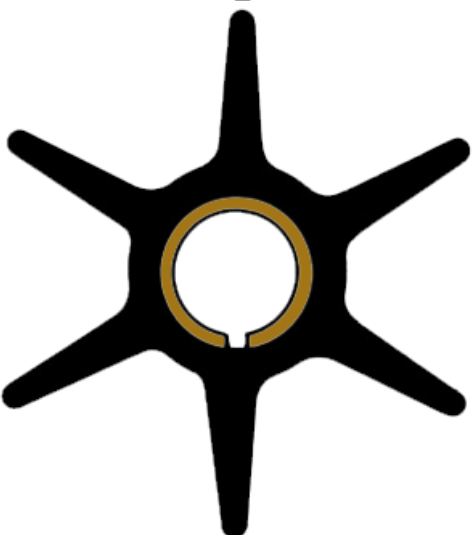

Codice Code	Ext. Diam.	Int. Diam.	Altezza Depth	Ins.	Pale Blades	Material
2066	69.50	16.5	13.00	3	6	Neoprene

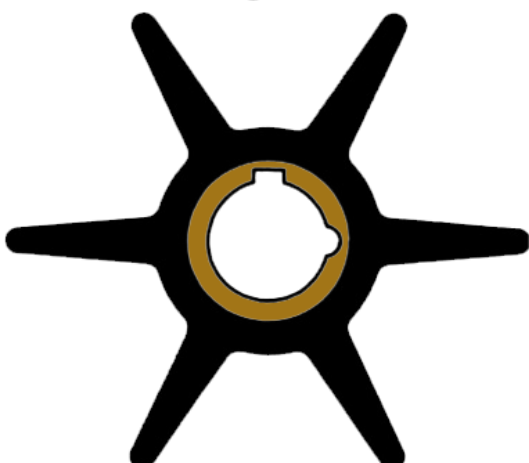

Codice Code	Ext. Diam.	Int. Diam.	Altezza Depth	Ins.	Pale Blades	Material
2070	69.50	16.20	22.70	3	6	Neoprene
2071	69.50	16.20	22.70	6	6	Neoprene

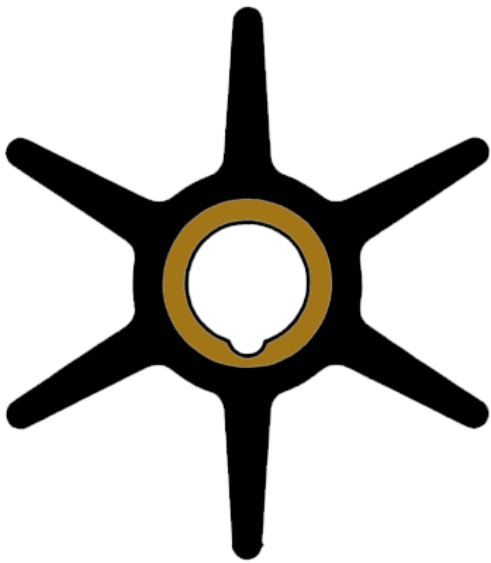

Codice Code	Ext. Diam.	Int. Diam.	Altezza Depth	Ins.	Pale Blades	Material
2999	73.00	16.20	12.50	6	6	Neoprene

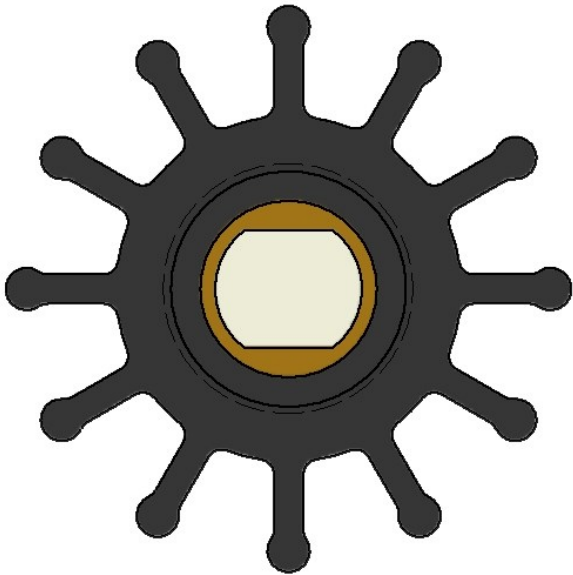

Codice Code	Ext. Diam.	Int. Diam.	Altezza Depth	Ins.	Pale Blades	Material
5353	77.00	20.00	76.20	8	12	Neoprene

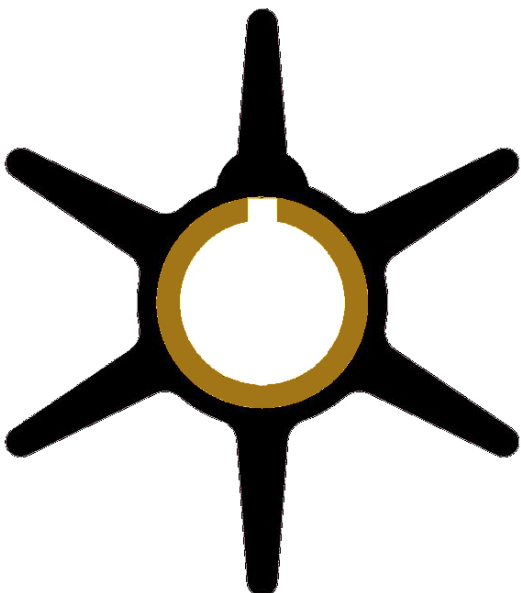

Codice Code	Ext. Diam.	Int. Diam.	Altezza Depth	Ins.	Pale Blades	Material
5373	77.90	22.10	26.00	3	6	Neoprene

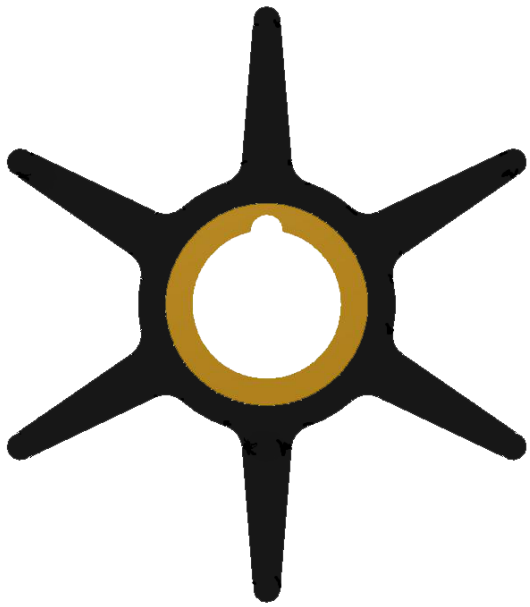

Codice Code	Ext. Diam.	Int. Diam.	Altezza Depth	Ins.	Pale Blades	Material
5380	78.00	19.20	25.30	6	6	Neoprene

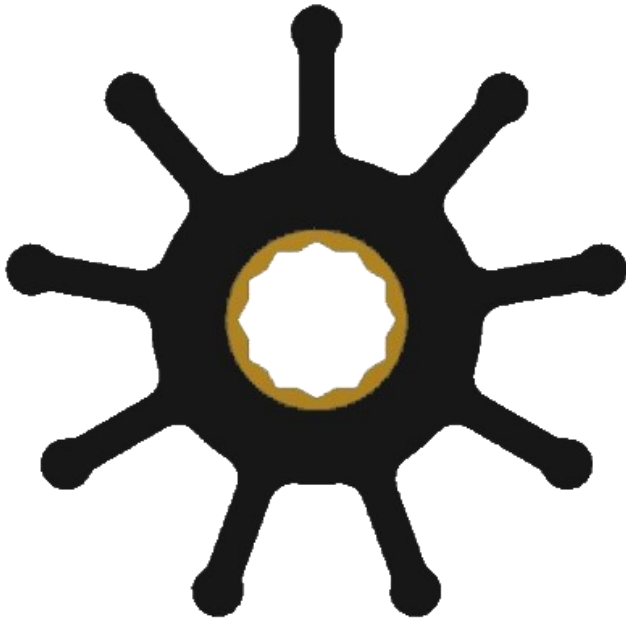

Codice Code	Ext. Diam.	Int. Diam.	Altezza Depth	Ins.	Pale Blades	Material
5886	80.00	20.00	75.00	4	9	Neoprene
6088	80.00	20.00	54.00	4	9	Neoprene
6508	80.00	20.00	54.00	3	9	Neoprene

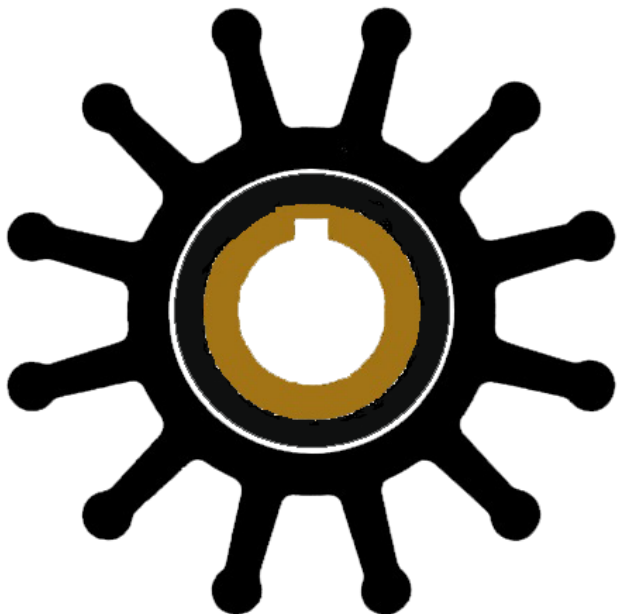

Codice Code	Ext. Diam.	Int. Diam.	Altezza Depth	Ins.	Pale Blades	Material
2672	82.50	20.10	73.00	3	12	Neoprene

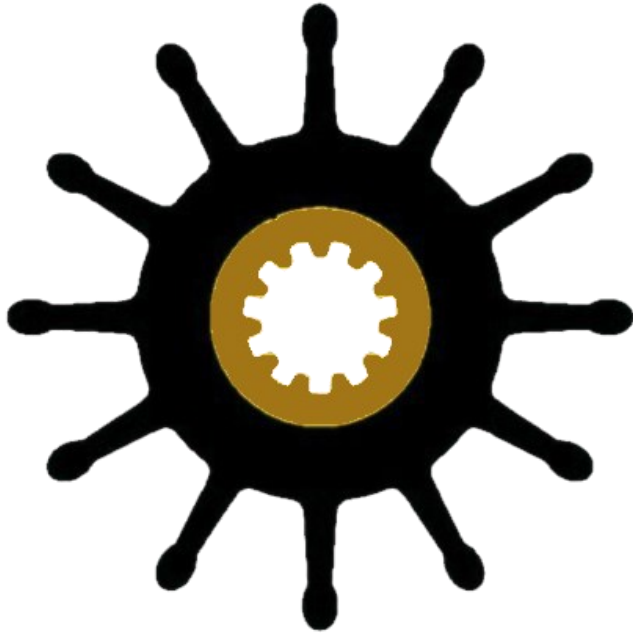

<i>Codice Code</i>	<i>Ext. Diam.</i>	<i>Int. Diam.</i>	<i>Altezza Depth</i>	<i>Ins.</i>	<i>Pale Blades</i>	<i>Material</i>
4861	82.50	20.10	73.00	4	12	Neoprene

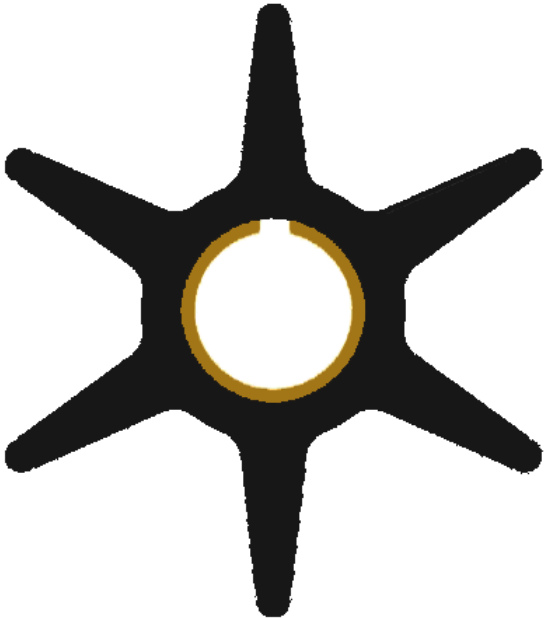

<i>Codice Code</i>	<i>Ext. Diam.</i>	<i>Int. Diam.</i>	<i>Altezza Depth</i>	<i>Ins.</i>	<i>Pale Blades</i>	<i>Material</i>
5374	86.00	24.10	31.60	3	5	Neoprene

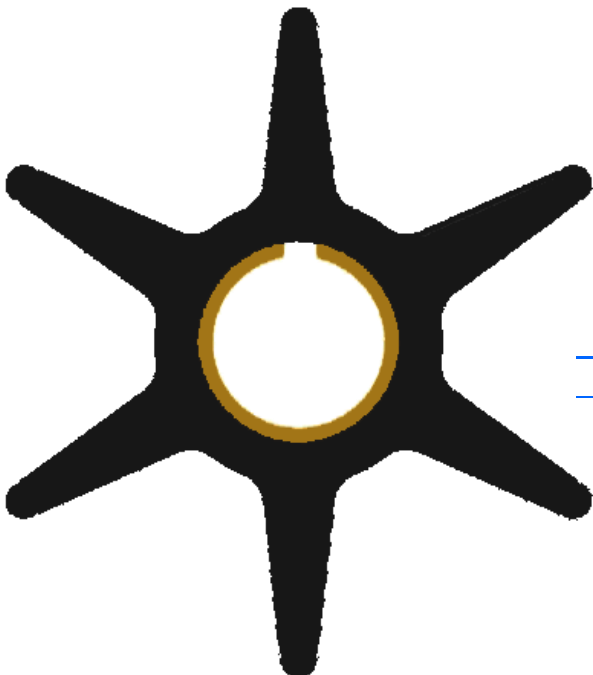

<i>Codice Code</i>	<i>Ext. Diam.</i>	<i>Int. Diam.</i>	<i>Altezza Depth</i>	<i>Ins.</i>	<i>Pale Blades</i>	<i>Material</i>
5365	88.00	22.60	31.00	3	6	Neoprene

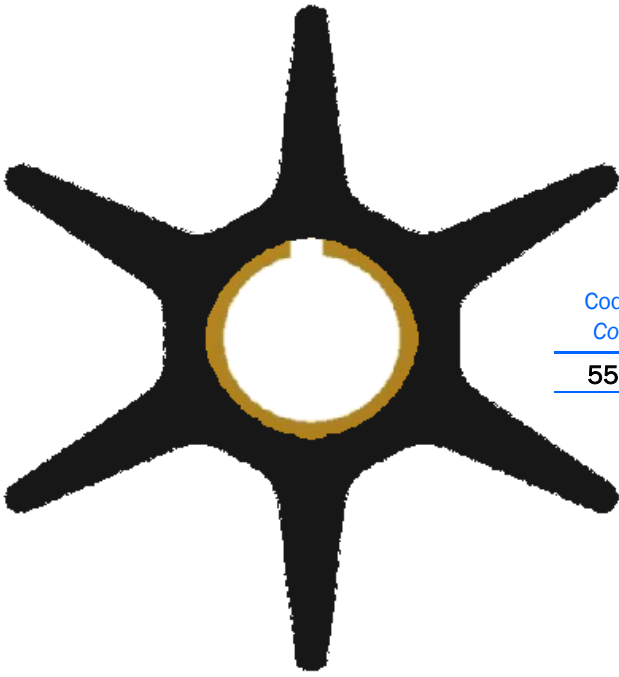

Codice Code	Ext. Diam.	Int. Diam.	Altezza Depth	Ins.	Pale Blades	Material
5568	88.00	23.00	31.00	3	6	Neoprene

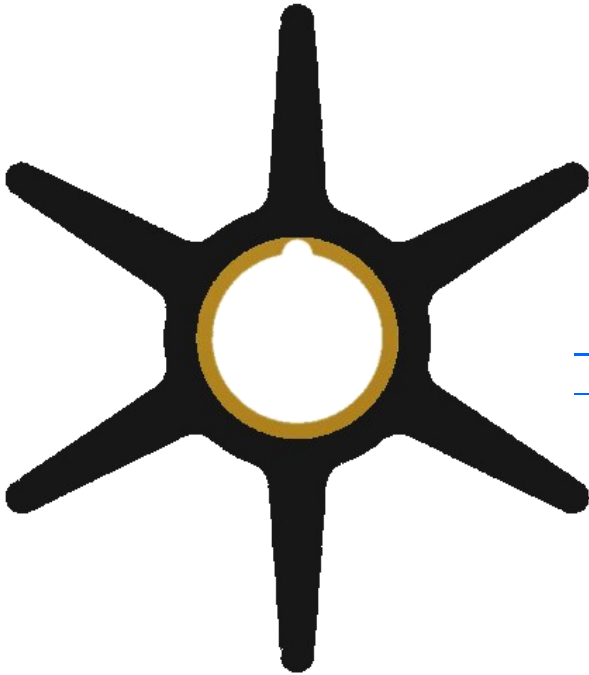

Codice Code	Ext. Diam.	Int. Diam.	Altezza Depth	Ins.	Pale Blades	Material
5381	88.40	22.30	32.30	6	6	Neoprene

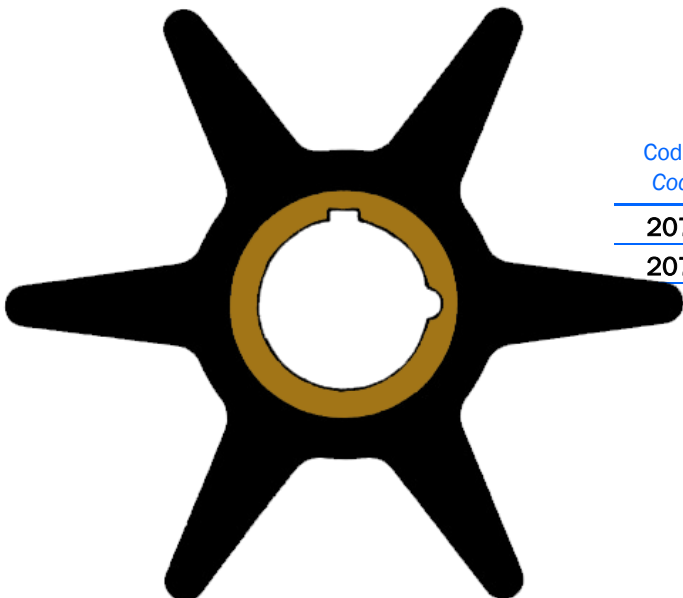

Codice Code	Ext. Diam.	Int. Diam.	Altezza Depth	Ins.	Pale Blades	Material
2075	89.30	22.20	32.00	6	6	Neoprene
2076	89.30	22.20	32.00	3	6	Neoprene

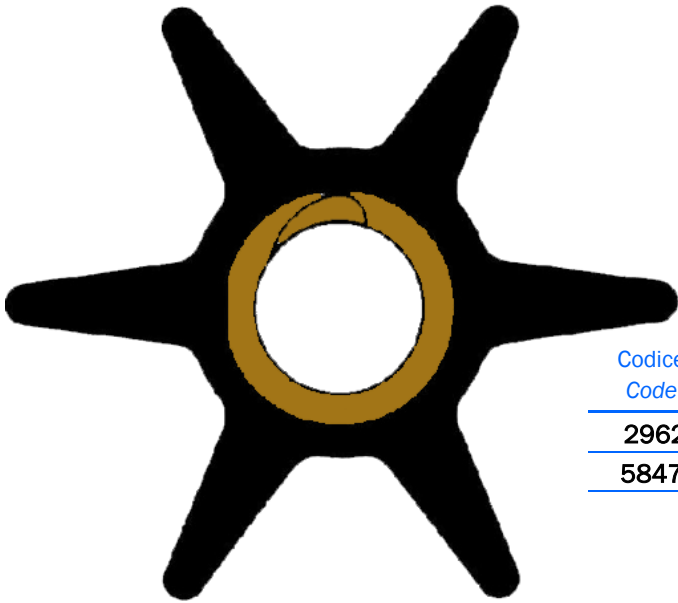

Codice Code	Ext. Diam.	Int. Diam.	Altezza Depth	Ins.	Pale Blades	Material
2962	89,30	22,2	32	9	6	Neoprene
5847	91.50	19.20	25.40	9	6	Neoprene

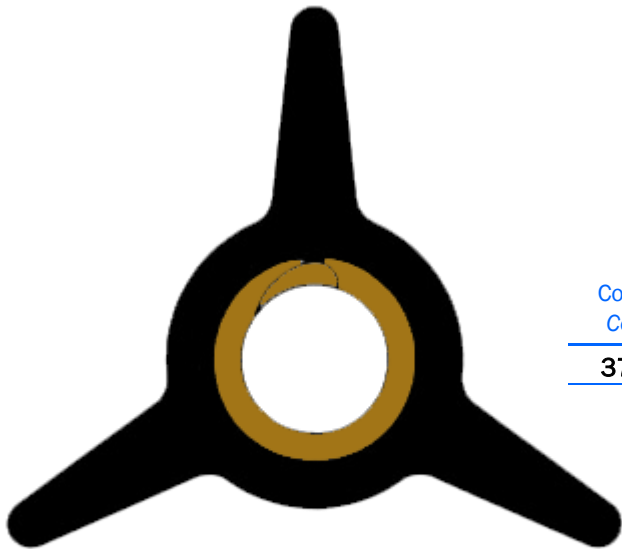

Codice Code	Ext. Diam.	Int. Diam.	Altezza Depth	Ins.	Pale Blades	Material
3794	90.00	19.00	25.50	9	3	Neoprene

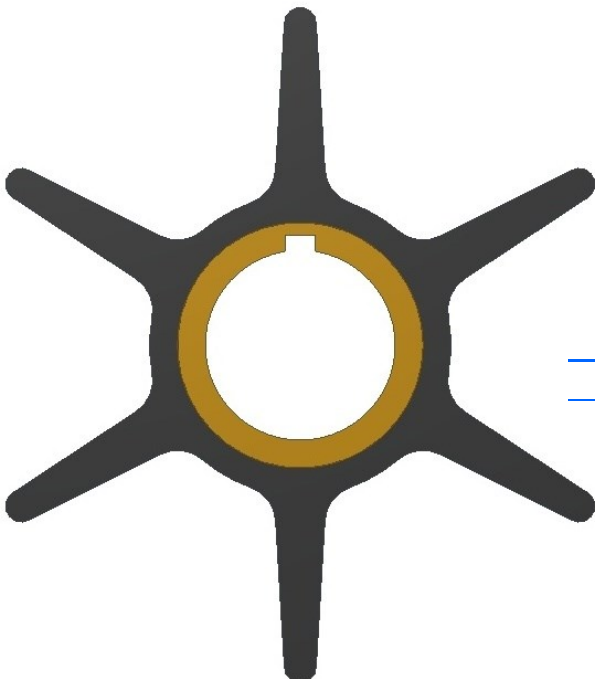

Codice Code	Ext. Diam.	Int. Diam.	Altezza Depth	Ins.	Pale Blades	Material
6003	90.00	26.00	31.20	3	6	Neoprene

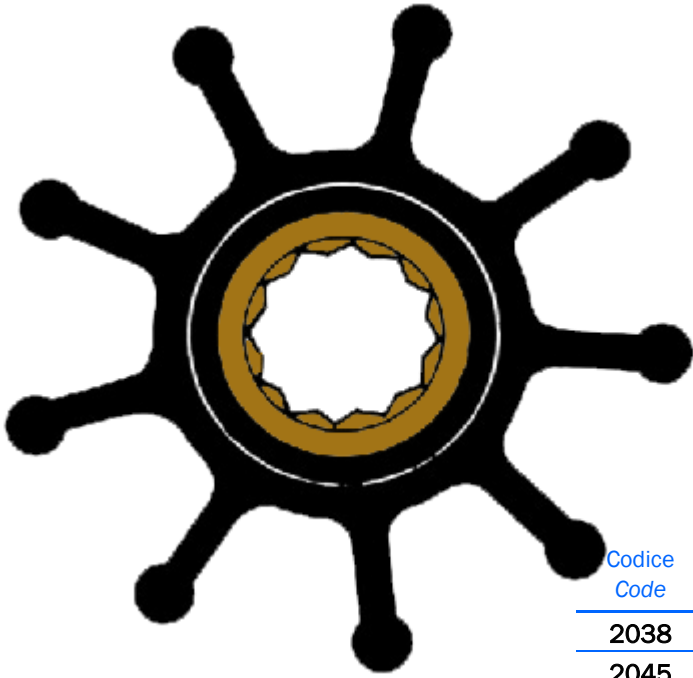

Codice Code	Ext. Diam.	Int. Diam.	Altezza Depth	Ins.	Pale Blades	Material
2038	95.00	25.00	63.00	4	9	Neoprene
2045	95.00	25.00	88.50	4	9	Neoprene
2717	95.00	25.00	63.00	4	9	Nitrile
3406	95.00	25.00	88.50	4	9	Nitrile
4915	95.00	25.00	96.00	4	9	Neoprene

Codice Code	Ext. Diam.	Int. Diam.	Altezza Depth	Ins.	Pale Blades	Material
2053	95.00	25.00	63.00	4	12	Neoprene
2054	95.00	25.00	88.50	4	12	Neoprene
2718	95.00	25.00	63.00	4	12	Nitrile
3261	95.00	25.00	88.50	4	12	Nitrile
3315	95.00	25.00	130.00	4	12	Neoprene
5641	95.00	25.00	180.00	4	12	Neoprene

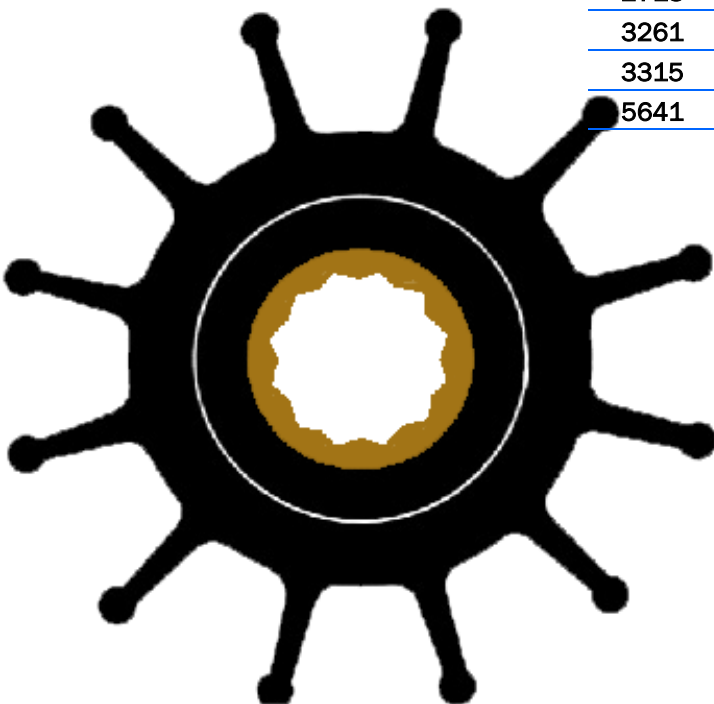

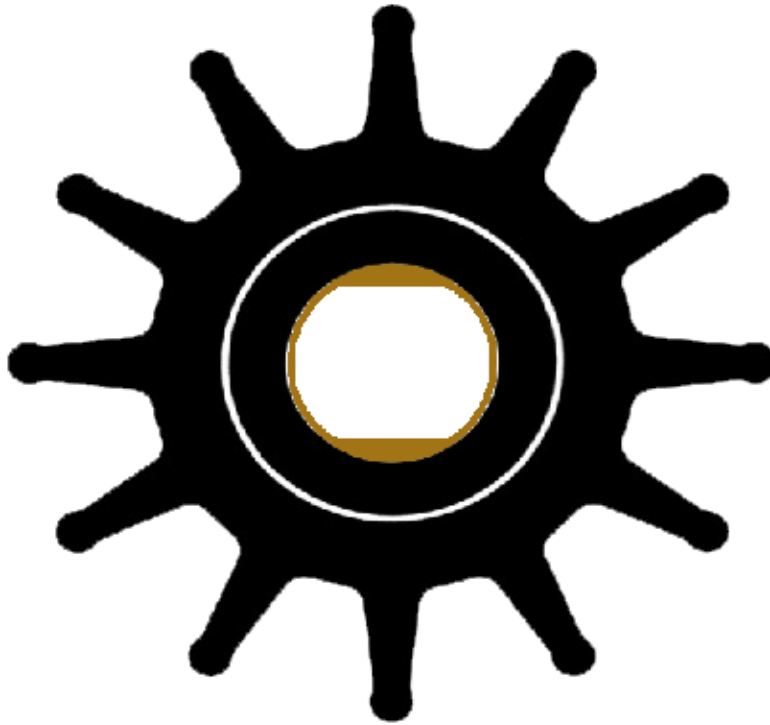

Codice Code	Ext. Diam.	Int. Diam.	Altezza Depth	Ins.	Pale Blades	Material
2654	95.00	25.00	63.00	8	12	Neoprene
2655	95.00	25.00	88.50	8	12	Neoprene

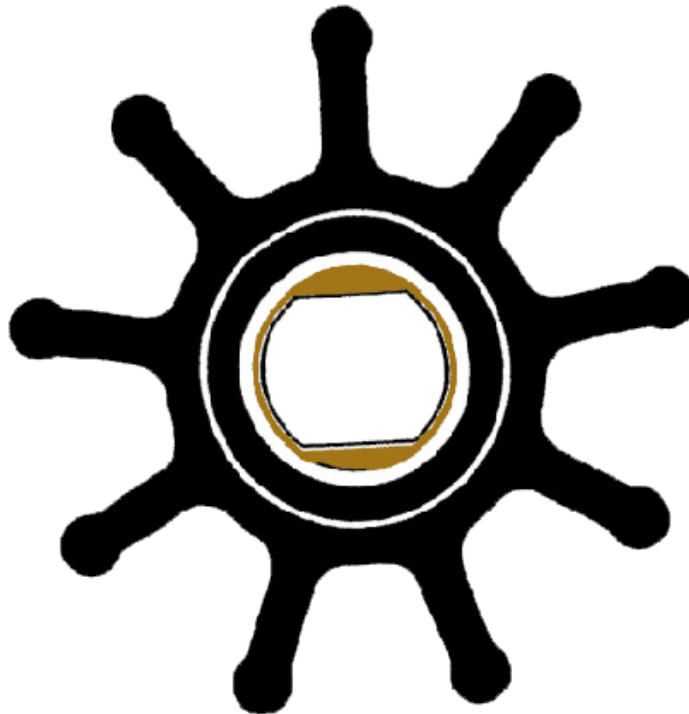

Codice Code	Ext. Diam.	Int. Diam.	Altezza Depth	Ins.	Pale Blades	Material
3455	95.00	25.00	88.50	8	9	Neoprene
3821	95.00	25.00	63.50	8	9	Neoprene

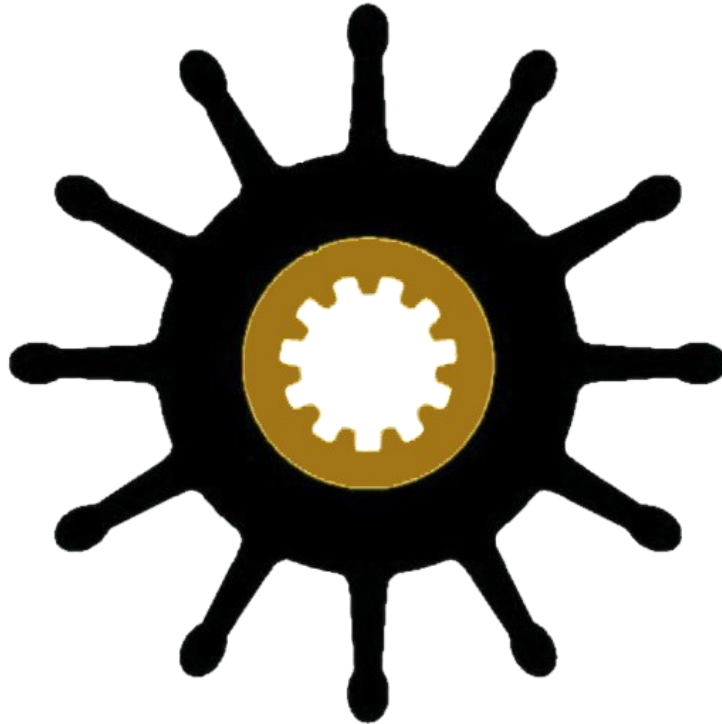

<i>Codice Code</i>	<i>Ext. Diam.</i>	<i>Int. Diam.</i>	<i>Altezza Depth</i>	<i>Ins.</i>	<i>Pale Blades</i>	<i>Material</i>
5062	95.00	25.00	102.00	4	12	Neoprene
5063	95.00	25.00	80.00	4	12	Neoprene
5749	95.00	25.00	102.00	4	12	Neoprene

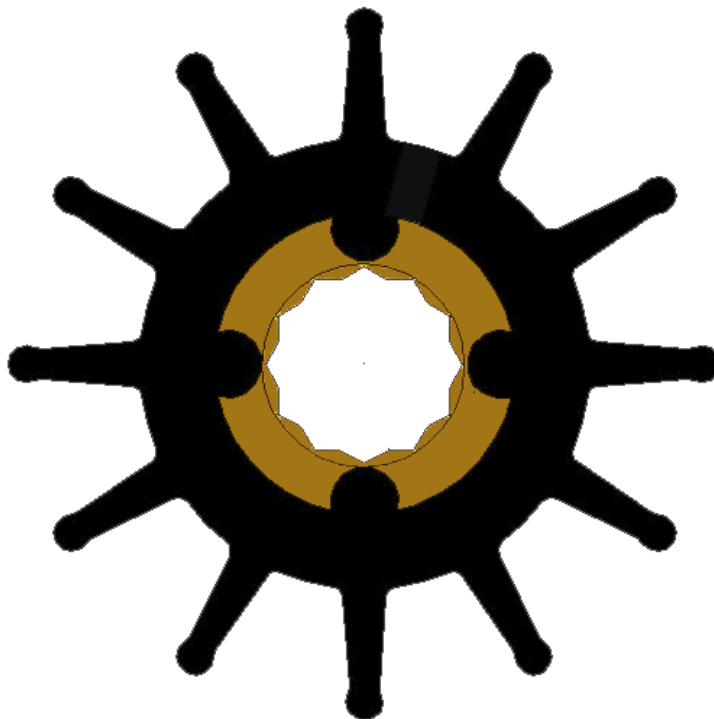

<i>Codice Code</i>	<i>Ext. Diam.</i>	<i>Int. Diam.</i>	<i>Altezza Depth</i>	<i>Ins.</i>	<i>Pale Blades</i>	<i>Material</i>
5288	95.00	25.00	95.00	4	12	Neoprene

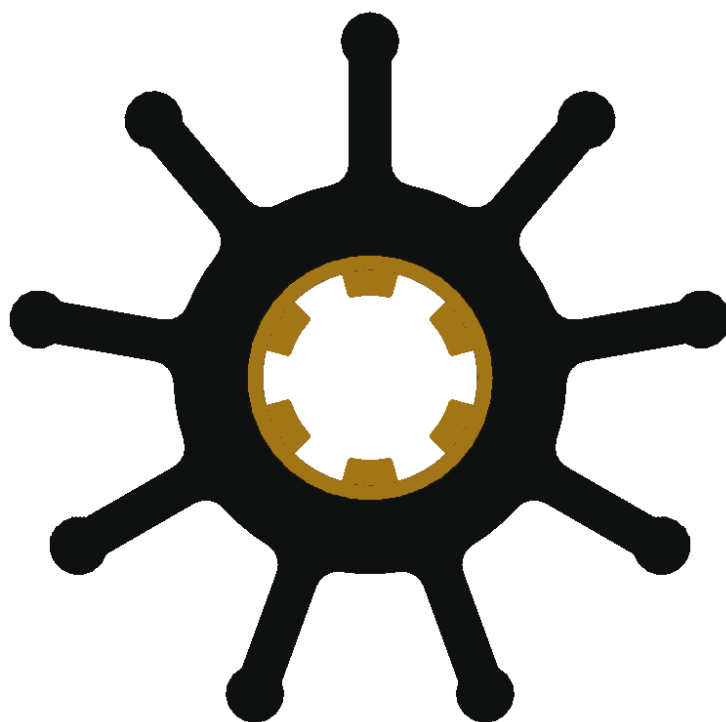

<i>Codice Code</i>	<i>Ext. Diam.</i>	<i>Int. Diam.</i>	<i>Altezza Depth</i>	<i>Ins.</i>	<i>Pale Blades</i>	<i>Material</i>
5953	95	22	63	4	9	Neoprene

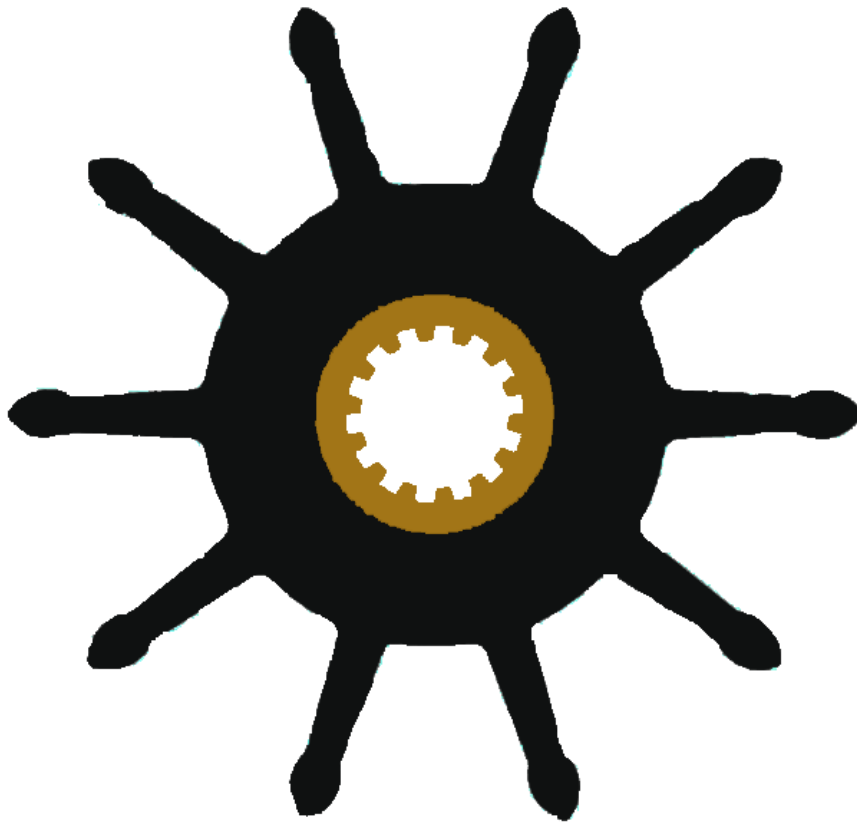

Codice Code	Ext. Diam.	Int. Diam.	Altezza Depth	Ins.	Pale Blades	Material
3648	114.00	25.00	109.80	4	10	Neoprene
5750	114	25.00	109.60	4	10	Neoprene

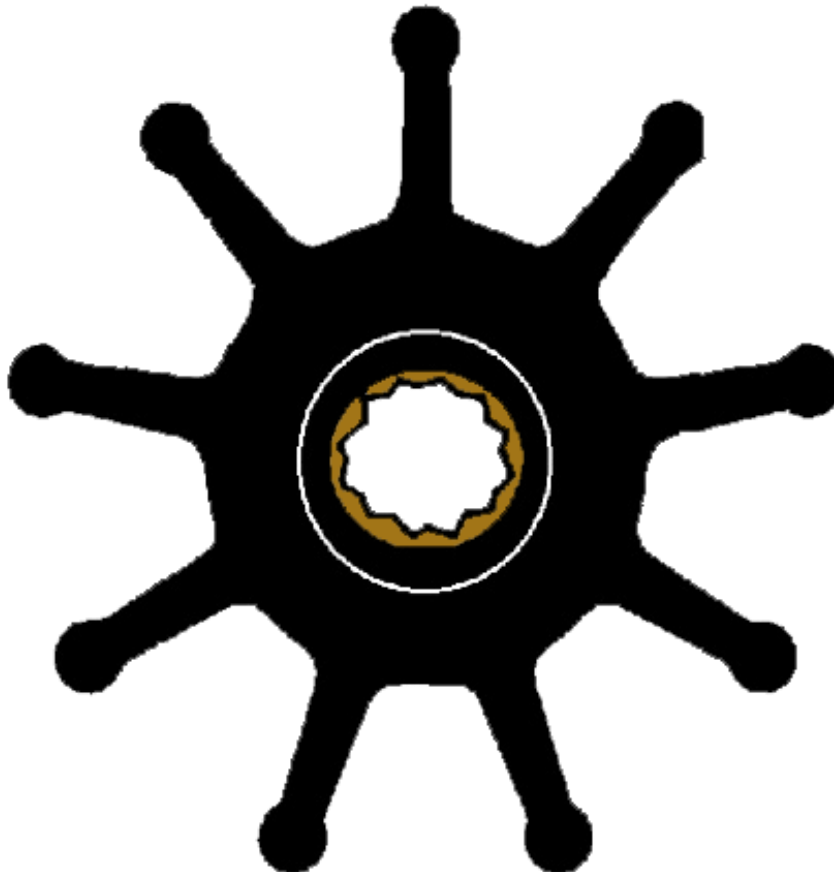

Codice Code	Ext. Diam.	Int. Diam.	Altezza Depth	Ins.	Pale Blades	Material
5293	117.00	25.40	130.00	4	9	Neoprene
4738	118.00	25.00	88.40	4	9	Neoprene
4823	118.00	25.00	88.40	8	9	Neoprene

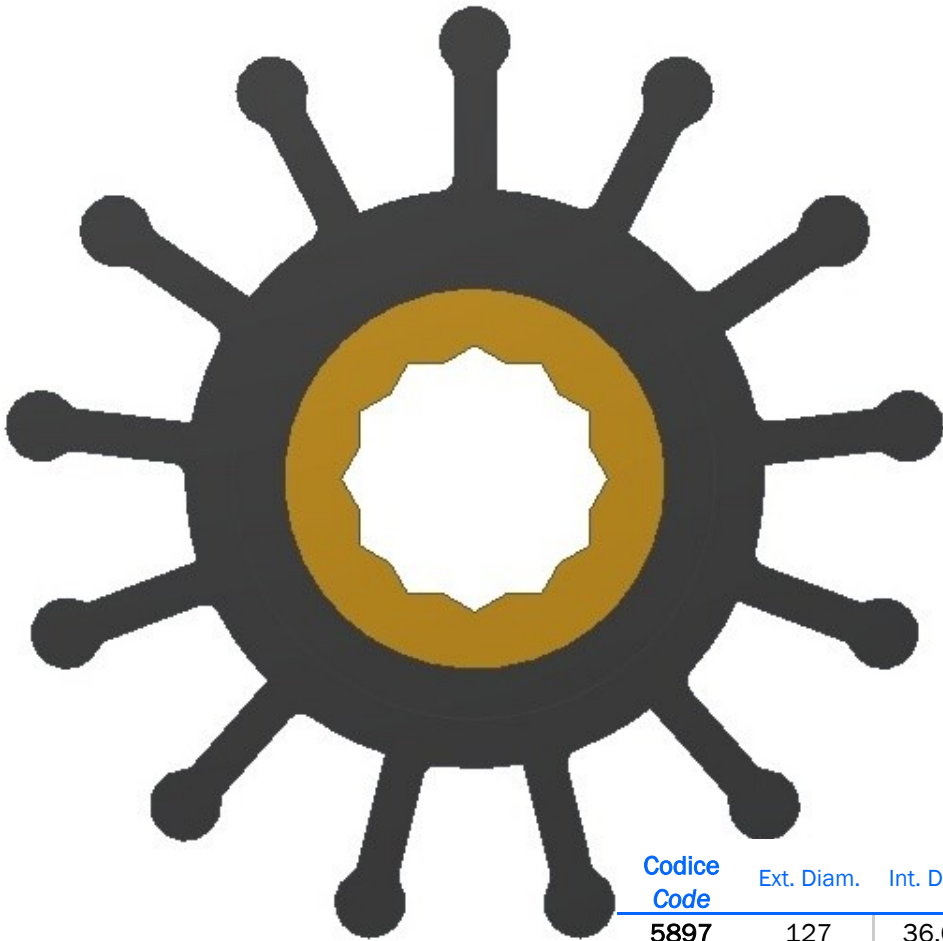

Codice Code	Ext. Diam.	Int. Diam.	Altezza Depth	Ins.	Pale Blades	Material
5897	127	36.00	127	4	13	Neoprene

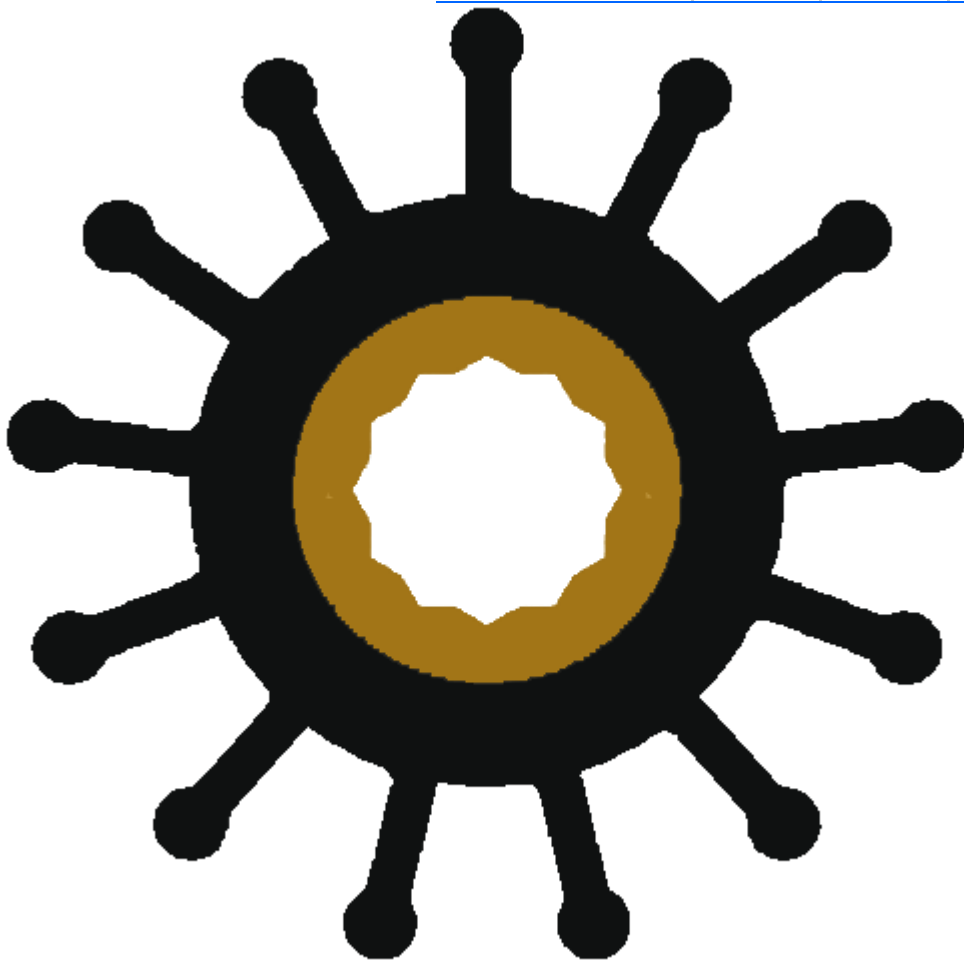

Codice Code	Ext. Diam.	Int. Diam.	Altezza Depth	Ins.	Pale Blades	Material
5842	126.9	36.00	102.00	4	13	Neoprene

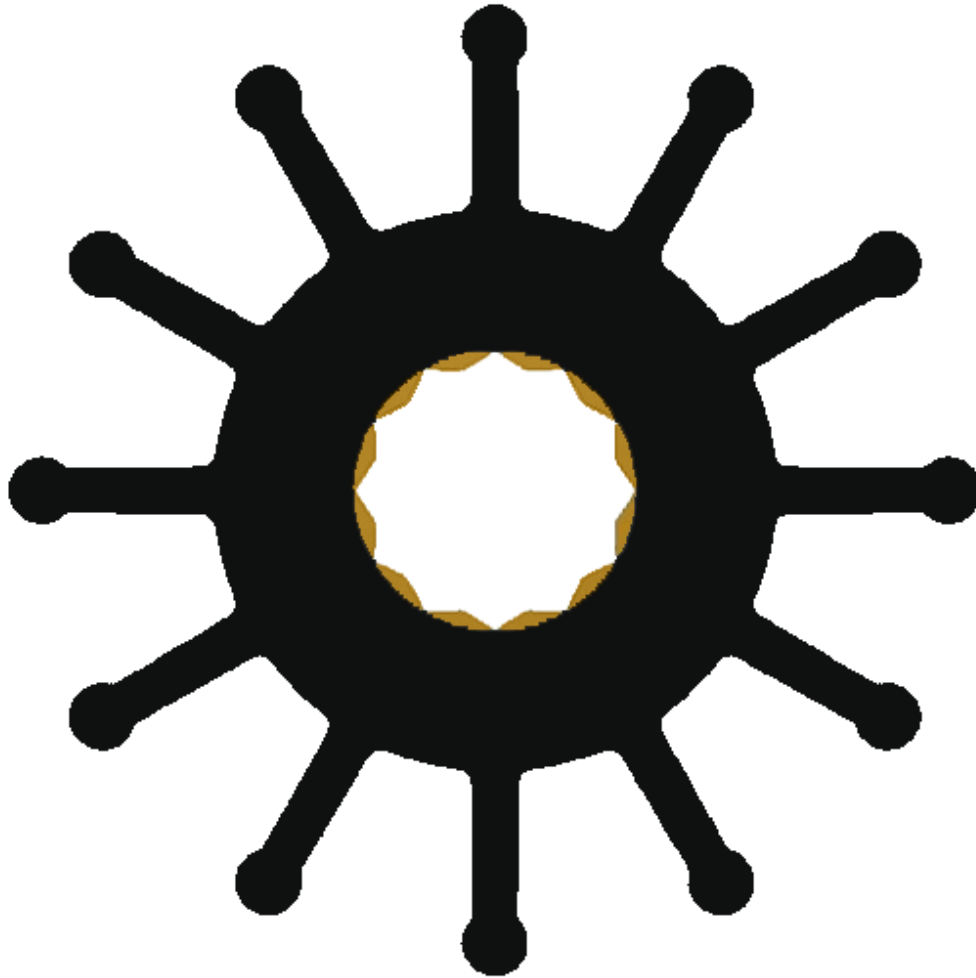

Codice Code	Ext. Diam.	Int. Diam.	Altezza Depth	Ins.	Pale Blades	Material
5757	128	36.00	101.50	4	12	Neoprene

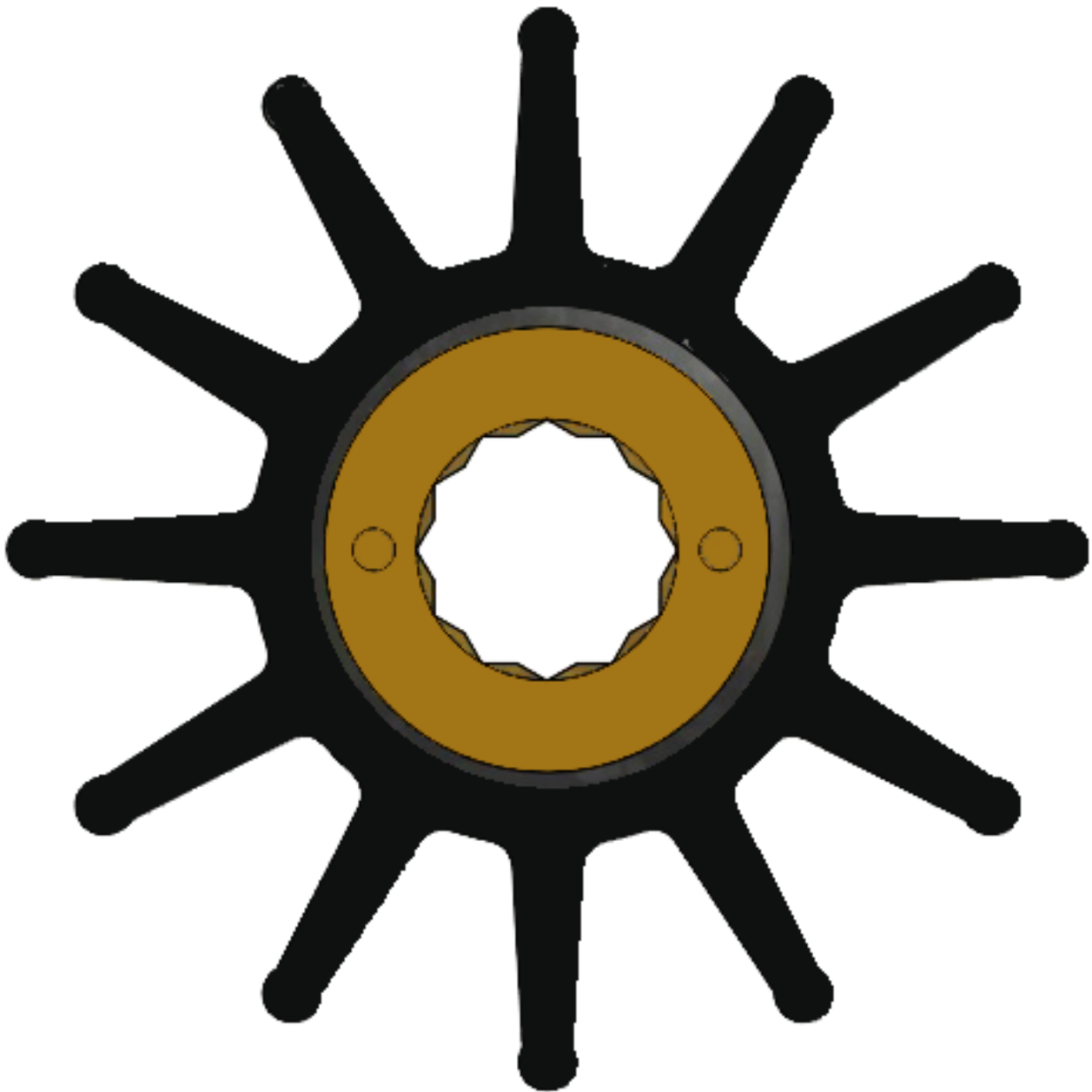

Codice Code	Ext. Diam.	Int. Diam.	Altezza Depth	Ins.	Pale Blades	Material
6908	165	36.00	120.00	4	12	Neoprene

Codice	Fog.	DE	DI	H	Ins	Pale	Mat.	Jabscó	Johnson	Volvo	Mercury	Yamaha	Omc	CEF	Altri
536	2	32,00	8,10	13,00	5	6	NIT	14609-0003 - 14787-0003							E JABSCO 1414-0003
568	8	51,00	8,10	22,00	5	10	NIT							500200	
1872	4	40,00	8,10	19,00	5	6	NEO	9200-00001							ONAN - ANCOR ST 103
2036	14	65,00	16,00	50,80	3	8	NEO	4598-0001							FULL KEY JK 7410-01 SHER- WOOD 10187
2037	14	61,90	16,00	31,50	3	12	NEO	18838-0001		835512- 3854286		YSC-101-03-01 -0C		500103	PERKINS NA900010 SHER- WOOD 09959 ONAN 132-01117
2038	24	95,00	25,00	63,00	4	9	NEO	836-0001	09-1029 B					500105	JMP 8000-01 KASH KP-220 VET.IMP00901
2039	15	65,00	16,00	50,80	4	8	NEO	920-0001	09-1028 B	801277					KASH. SP-70 -SHERWOOD 18200 JMP 7400-01
2040	11	57,00	16,00	31,50	4	12	NEO	1210-0001	09-1027B	860203				500107G T	KASH. SP-30 YANMAR 129470- 42530 129670-42531 VET.IMP00201 PERK.0460038
2041	11	57,00	16,00	31,50	3	12	NEO	4568-0001	09-801 B	875575-3				500108C GX	VOLVO 831182 OBERDOFER B6620
2042	15	65,00	16,00	50,20	4	10	NEO	17937-0001		3588475				500114	KASH.KP-70 YANMAR 127610- 42200 VETUS IMP00301 PERK. 0460024 VOLVO 3841697 - 825941
2043	4	40,00	9,60	19,00	1	6	NEO	4528-0001	09-806 B	803729				500100G X	YM 104211-42070 VOLVO 875807 JMP 7001-01
2044	2	32,00	8,10	12,00	5	6	NEO	21414-0001						500113	YANMAR 128170-42070 E JAB- SCO 1414-0001 - 14787-0001 - 14609-0001 JMP 6000-01
2045	24	95,00	25,00	88,50	4	9	NEO	6760-0001	09-802 B						KASH SP-280 JMP 8200-01 VETUS IMP00601
2046	8	51,00	12,70	22,00	1	6	NEO	673-0001	09-1026 B	804696				500116	VET. IMP00101 VOL. 897055- 875808 JMP 7051-01
2047	15	65,00	16,00	41,40	3	12	NEO	18948-0001		835874-9		6TA-12457-00		500120	SHERW 10615 ONAN 132-0349 JMP 7300-01
2048	4	40,00	12,00	19,00	1	6	NEO	22405-0001	09-808 B	35866501				500121G X	VETUS IMP00601 JMP 7000-01 ONAN 132-0310
2049	8	51,00	10,00	22,00	3	6	NEO								RENAULT COUACH 48300055 - 20/80 HP
2050	14	66,00	17,00	32,00	3	8	NEO							500128	RENAULT COUACH 48300002
2051	8	51,00	13,00	22,00	3	6	NEO								YANMAR 124223-42091 HP35
2052	8	51,00	12,70	22,00	5	6	NEO								ONAN KUBOTA 3/6 HP

Codice	Fog.	DE	DI	H	Ins	Pale	Mat.	Jabco	Johnson	Volvo	Mercury	Yamaha	Omc	CEF	Altri
2053	24	95,00	25,00	63,00	4	12	NEO	17935-0001	09-819 B	807904				500135	JK 8100-01 VET. IMP00901 VOL-VO 875660 875736
2054	24	95,00	25,00	88,50	4	12	NEO	17936-0001	09-814 B					500145	VET.IMP00801 PERKINS 0460027 JMP 8301-01
2055	2	32,00	12,00	13,30	6	6	NEO				47-65957/89981				WHITEHAD 6-12 HP MERCURY 25 HP
2056	8	51,00	17,00	19,10	6	6	NEO								WHITEHAD 20-25 HP
2057	2	32,00	11,60	14,40	6	6	NEO				47-65957/89981			500310	MERCURY 4,5 - 7,5 - 9 HP
2058	8	51,00	16,00	19,10	6	6	NEO				47-65958/89982		38870		MERCURY 20 HP OMC 38870
2059	9	51,00	19,10	19,00	6	6	NEO				47-65959/899983				MARINER 50 HP - 47-20268
2060	14	60,00	22,30	33,65	6	6	NEO				47-65960/89984	6E5-44352			MARINER HP 80-90-115-135-140 -175-200-220
2061	2	32,00	11,15	14,35	6	6	NEO				47-68988/89980				MERCURY 3,6 - 4 HP
2062	13	59,50	12,70	12,00	6	6	NEO				47-42038			500318	MERCURY 8 HP
2063	4	40,00	13,10	22,00	3	6	NEO				47-84027	682-44352		500320	MARINER 15 HP
2064	4	40,00	14,20	22,00	3	6	NEO				47-95611	662-44352		500321	YAMAHA - 6G1-44352-00 MARINER 8,8 HP
2066	18	69,50	13,00	13,00	3	6	NEO				47-84797	689-44353			MARINER 25 HP
2067	6	41,00	14,00	23,00	5	8	NEO	19210-881-A01 19210-881-1003							HONDA 7,6 - 8 HP
2068	17	69,50	11,00	12,95	3	6	NEO						277181		OMC 6 HP
2069	17	69,50	12,75	12,80	3	6	NEO						375638		375638 20 HP 377178 9,5 HP
2070	18	69,50	16,20	22,70	3	6	NEO					676-44352	377230	500352	OMC 40 HP MERCURY 88 HP
2071	18	69,50	16,20	22,70	6	6	NEO						389589		MERCURY 25 HP OMC 50-55-60 HP
2072	3	38,40	11,10	17,90	6	6	NEO						389576	500354G	ENVIRUDE 7,5 HP OMC 6HP
2073	3	38,40	12,80	17,80	6	6	NEO						386084	500355	OMC 9,9 HP
2074	9	51,00	16,00	19,10	6	6	NEO						395289		OMC 25 HP
2075	22	89,30	22,20	32,00	6	6	NEO				47-43026-2		389289	500301	OMC 70 HP - 391538 -
2076	22	89,30	22,20	32,00	3	6	NEO					115-250	389642	500371	OMC 70 HP YAMAHA 115-250 HP-SUZUKI 17461-95300

Codice	Fog.	DE	DI	H	Ins	Pale	Mat.	Jabsc	Johnson	Volvo	Mercury	Yamaha	Omc	CEF	Altri
2077	15	65,00	16,00	50,20	4	8	NIT	92037 - 920-0003	08-1028-B9						
2078	11	57,00	16,00	31,50	4	12	NIT	121037-1210-0003	1027 B - 9					500207	OMC 6 HP EVINRUDE 7.5 HP
2079	6	45,00	8,10	12,80	5	6	NIT		09-1052 S9					500232	
2080	8	51,00	8,10	22,00	5	6	NIT	6303-0003	09-824 P						JABSCO 7273-0003
2081	11	56,00	12,10	29,40	3	12	NIT								ANCOR PM 16—EP60
2522	8	51,00	12,00	22,00	1	6	NEO	18653-0001	09-810 B						
2555	2	32,00	11,60	14,40	2	6	NEO				47-22748 B				
2654	25	95,00	25,00	63,00	8	12	NEO								
2655	25	95,00	25,00	88,50	8	12	NEO	17370-0001-B							
2672	20	82,50	20,10	73,00	3	12	NEO	18958-0001							SHERWOOD 17000
2717	24	95,00	25,00	63,00	4	9	NIT	836-0003	09-1029-9					500205	
2718	24	95,00	25,00	63,00	4	12	NIT	17935-0003 - 836-0003	09-819 B9						
2745	8	51,00	8,10	22,00	5	6	NEO	6303-0003-4 - 7273-0001							
2789	11	57,00	16,00	50,80	4	12	NEO	22120-0001B						500104	
2962	23	89,3	22,2	32	9	6	NEO		3031-5001593					500308 RC	
2999	19	73,00	16,20	12,50	6	6	NEO				47-85089 - 25 HP - 47-85089/2			500315	
3260	15	65,00	16,00	76,20	4	8	NEO	17018-0001		3593573	47-816814T				VOLVO 3588476-3593573-21730348-3817587
3261	24	95,00	25,00	88,50	4	12	NIT	17936-0003							E JABSCO - 21676-0003
3265	13	57,70	18,10	22,60	6	6	NEO								SELVA 40 HP -100 HP- 80950-60
3267	11	57,00	16,00	48,20	4	12	NEO	13554-0001	09-812 B	21213664					VOLVO 3588914-3584350 YAN-MAR 119773-42600
3268	4	40,00	10,00	19,00	1	6	NEO		09-806B	875807-0					SHERWOOD 9979 JMP 7001-01 VETUS IMP00501
3269	8	51,00	12,70	22,00	1	6	NIT	673-0003	09-1026B-9	875808-8				500216	
3315	24	95,00	25,00	130,00	4	12	NEO		09-820B						MAN 51.06506.0106
3342	11	56,00	12,10	29,40	3	12	NEO								ANCOR PM 16— EP60 ST175

Codice	Fog.	DE	DI	H	Ins	Pale	Mat.	Jabasco	Johnson	Volvo	Mercury	Yamaha	Omc	CEF	Altri
3374	9	51,00	18,25	18,85	6	6	NEO				47-97108				YAMAHA MARINER 55 HP
3375	3	38,40	11,20	17,90	3	6	NEO							3375	EVINRUDE 387361
3376	9	51,00	14,00	19,00	3	6	NEO					6L2-44352			
3377	9	51,00	16,00	19,00	3	6	NEO					6H4 -44352			MARINER TOP 700
3378	2	32,00	10,10	14,40	6	6	NEO					47-161-154			MERCURY 4-5 HP
3379	14	65,40	17,00	48,40	3	8	NEO						500122T		RENAULT 48300008
3386	17	66,00	19,00	50,50	5	8	NEO	17954-0001							
3388	15	65,00	16,00	32,00	4	8	NEO								ALIAS 15410
3392	12	57,00	16,00	31,50	8	12	NEO	14281-0001							
3398	10	51,00	8,00	22,00	1	6	NEO	4527-0001							
3399	10	51,00	8,00	22,00	1	6	NIT	4527-0003							
3403	11	57,00	16,00	31,50	3	12	NIT	1203/4598-0001							RENAULT 48300008
3404	4	40,00	10,00	19,00	1	6	NIT	4528-0003							
3405	15	65,00	16,00	50,20	4	10	NIT	17937-0003							
3406	24	95,00	25,00	88,50	4	9	NIT	6760-0003							
3407	14	65,00	16,00	50,80	3	8	NIT	4598-0003							SHERWOOD 12338
3408	15	65,00	16,00	36,50	4	8	NEO	11979-0001							DAEWOO 65.06804-0005 JMP 7200-01
3410	14	66,00	17,00	32,00	3	8	NIT	4568-0003							RENAULT COUACH 48380008
3411	8	51,00	12,00	22,00	1	6	NIT	18653-0003	09-810 B-9						
3414	11	57,00	20,00	31,50	3	12	NIT		09-804 B-9						
3455	25	95,00	25,00	88,50	8	9	NEO	17370-0001							
3500	16	65,00	15,00	15,00	7	6	NEO								TOMOS
3509	15	65,00	16,00	68,30	4	8	NEO	311130 - 0061			47-831311350				YANMAR 6YL 119593-42200 JMP 7420 KASH SP-130
3630	4	40,00	11,80	18,00	3	6	NEO					6G1-44352-00	500302		YAMAHA 6 HP
3648	28	114,00	25,00	109,80	4	10	NEO								SHERWOOD 22000 CATERPIL- LAR 153-9123
3666	17	67,00	19,80	19,20	3	6	NEO						500360		SUZUKI -17461-95300 E 17461- 95501

Codice	Fog.	DE	DI	H	Ins	Pale	Mat.	Jabasco	Johnson	Volvo	Mercury	Yamaha	Omc	CEF	Altri
3667	17	67,00	17,00	19,20	3	6	NEO							500361	SUZUKI 17461-94700 E 17461-95201
3668	17	67,00	17,00	16,00	3	6	NEO							500362G	SUZUKI 17461-96301 MOTO-RIDT40-50-60-65 HP
3790	15	65,00	16,00	50,80	3	12	NEO	18327-0001							SHERWOOD 15000
3791	4	40,00	10,80	12,60	3	6	NEO					6E0-44352			MARINER 4 - 5 HP
3792	11	53,00	15,00	20,00	6	6	NEO								SELVA 20 - 35 HP
3793	7	48,00	13,00	15,00	6	6	NEO								SELVA 8 - 10 - 15 HP
3794	23	90,00	19,00	26,50	9	3	NEO						737	500372	OMC 737 EVINRUDE 25-40-50 HP
3821	25	95,00	25,00	63,50	8	9	NEO								JMP 8001-1 PER POMPA DAEWOO 60.06804-0010
3823	10	51,00	12,10	22,00	1	10	NEO	18653-0001B							JMP 7050-01
3830	10	51,00	12,70	22,00	1	10	NEO	18673-0001							
3852	2	32,00	8,10	12,00	5	6	NIT	14787-0003							JABSCO 14140-0003 E 14609-0003
3950	12	57,00	12,70	19,80	3	12	NEO								SHERWOOD 10077
4030	2	35,00	12,00	15,00	3	6	NEO								FAIRWAYS- STUART TURNER
4205	16	65,00	25,00	80,00	4	12	NEO		09-821B	876771		YM119574-42550			CEF500162G
4738	28	118,00	25,00	88,40	4	9	NEO	18789-0001							E JABSCO - 17240-0001
4807	5	40,00	12,10	19,00	5	6	NEO								ONAN 132-0407 SHERWOOD 8000
4813	16	65,00	16,00	50,80	2	8	NEO								FINSRAY 3/4 HALF KEY
4821	15	65,00	16,00	41,40	4	12	NEO								KASHIYAMA SP60
4823	28	118,00	25,00	88,40	8	9	NEO	18786-0001							SHERWOOD 27000
4861	21	82,50	20,10	73,00	4	12	NEO								
4915	24	95,00	25,00	96,00	4	9	NEO								YANMAR
4988	14	62,20	16,00	22,20	3	12	NEO								SHERWOOD 9000
5053	8	51,00	12,00	22,00	1	6	NEO								W48080 PIN 4 mm
5062	26	95,00	25,00	102,00	4	12	NEO								SHERWOOD 18000
5063	26	95,00	25,00	80,00	4	12	NEO								SHERWOOD 26000
5192	10	52,00	12,00	25,00	1	6	NEO							500123X	SOLE 312.11.008

Codice	Fog.	DE	DI	H	Ins	Pale	Mat.	Jabsco	Johnson	Volvo	Mercury	Yamaha	Omc	CEF	Altri
5272	5	40,00	10,00	14,00	7	6	NEO							500336	SUZUKI 17461-98501 (2HP) SIERRA 18-3097
5288	26	95,00	25,00	95,00	4	12	NEO	17938-0001		3830459					
5293	28	117,00	25,40	130,00	4	9	NEO								ANCOR AS25
5353	19	77,00	20,00	76,20	8	12	NEO	30919-0001							
5355	7	48,00	11,00	13,80	3	6	NEO					2A 2B			
5356	3	36,00	9,70	14,50	3	6	NEO					6L5-44352-00			YAMAHA MALTA
5357	4	40,00	10,80	12,60	3	6	NEO					4A 5C			
5359	10	52,80	12,95	14,00	3	6	NEO					63V-44352-01-00			YAMAHA 9.9F 15F
5360	18	69,00	14,00	13,00	3	6	NEO					6F5-44352-00-00			YAMAHA C40 HP -
5361	10	51,60	13,90	18,70	3	6	NEO					20D 25N			
5362	10	51,80	16,20	18,80	3	6	NEO					30D 40H 50D			
5363	10	51,60	18,20	18,80	3	6	NEO					50G 60F 70B F45B F50A/B			
5364	13	58,00	20,20	29,70	3	6	NEO					75A 80A 85A 90A			
5365	21	88,00	22,60	31,00	3	6	NEO					115 V4U.V6 - 6E5-44352-00-00 6E5-44352-01-00			
5366	13	58,00	20,00	34,00	3	6	NEO					F80 100			
5367	10	52,80	12,00	13,85	3	6	NEO								
5369	3	39,00	13,20	21,90	3	6	NEO								SUZUKI DT9.9-15 DF9.9-15
5370	17	66,80	17,00	16,00	3	6	NEO								SUZUKI DT25C 30C
5371	17	66,80	17,00	19,00	3	6	NEO								SUZUKI DT55 55C 65 65C
5372	17	66,80	20,00	19,15	3	6	NEO								SUZUKI DT 75 85
5373	19	77,90	22,10	26,00	3	6	NEO								SUZUKI DT 100 DF60 70
5374	21	86,00	24,10	31,60	3	6	NEO								SUZUKI DF 60 70 90 115

